



MOMAD DENTAL SUPPLIES



DENTAL INSTRUMENTS CATALOGUE

www.momaddental.com



We are manufacturer and worldwide exporter of fine quality dental instruments.

Our instruments are made from the finest grade of stainless steel on precision security, accuracy of pattern and with latest technology. We also manufacture the similar instruments according to the samples and drawings on the special demands of our valued customers.

All instruments are made in our own facility by the workers who are best in their workmanship and commitment. Our products are produced with most top quality and well tested materials, and are in compliance with the international standards. To achieve the Heights and Peaks of everlasting success, we are providing our valued customers the quality products, timely services and related technical services through product development, innovation and acquisition of technology.

Your response will be highly appreciated. It will be our pleasure and honor to serve you.

With Regards,
Chief Executive

50



Extracting Forceps, American Pattern
Zahnzangen, Amerikanische Form
Daviers, forme américaine
Forceps de extracción, forma americana
Pinze per estrozione, forma americana

Page 01 to 15

51



Extracting forceps, English pattern
Zahnzangen, Englische Form
Daviers, forme anglaise
Fórceps dentales, forma inglesa
Pinze per estrazione, forma inglese

Page 16 - 39

52



Root Elevators
Wurzelheber
Elévateurs á racines
Botadores para raíces
Leve per radici

Page 40 to 54

53



Bone Files
Bone-Dateien
Archivos de huesos
Fichiers d'os
Bone Files

Page 55 to 56

54



Dental Probes
Zahnsonden
Sondas dentales
Sondes dentaires
Sonde dentali

Page 57 to 58

55



Enamel Instruments
Emaille-Instrumente
Instrumentos de esmalte
Instruments d'email
Strumenti per smalto

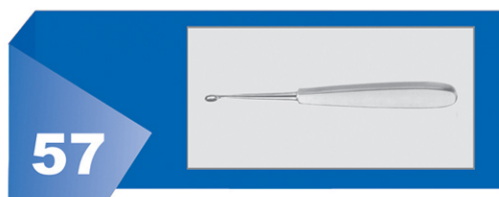
Page 59 to 62

56



Dental Scalers
Zahnsteinentferner
Escaladores dentales
Scalers dentaires
Scaler dentali

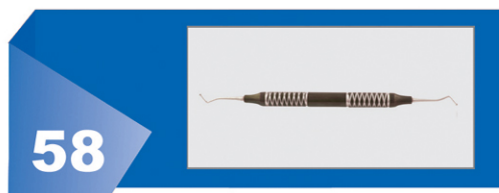
Page 63 to 78



57

Bone Currettes
Knochenküretten
Curetas de hueso
Currettes osseuses
Curette d'ossa

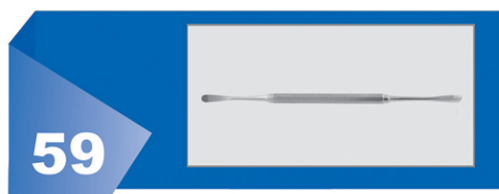
Page 79 to 84



58

Excavators
Bagger
Excavadoras
Pelles
escavatori

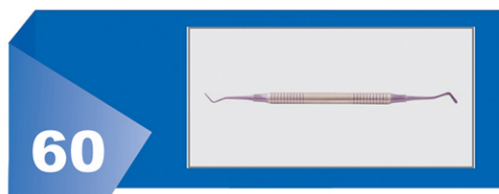
Page 85 to 89



59

Wax Proclein
Wachs-Porzellan
cera Porcelana
Cire Porcelaine
Cera porcellana

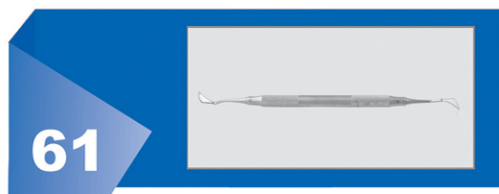
Page 90 to 94



60

Filling Instruments
Füllungsinstrumente
Actos de llenado
Instruments de remplissage
Strumenti di riempimento

Page 95 to 105



61

Gingivectomy Knives
Gingivektomie Messer
Cuchillos de gingivectomía
Couteaux de gingivectomie
Coltelli per gengivectomia

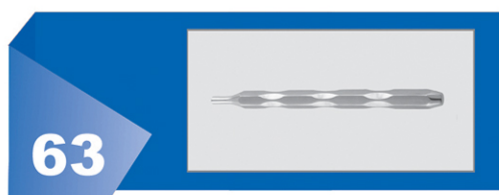
Page 106 to 107



62

Cement Spatulas
Zementspatel
Espátulas de cemento
Spatules de ciment
Spatole di cemento

Page 108 to 112



63

Mouth Mirrors
Mundspiegel
Espejos bucales
Bouche Miroirs
Bocca specchi

Page 113 to 115

64



Amalgam Instruments
Amalgam Instrumente
Instrumentos de amalgama
Instruments Amalgam
Strumenti amalgama **Page 116 to 117**

65



Matrix Retainers
Matrix-Halterungen
Retenedores de matrices
Retenue de matrice
Matrix Retainers **Page 118 to 125**

66



Hemostatic Forceps
Arterienklemmen
Pinces hemostaticas
Pinzashemostaticas
Pinze emostatiche **Page 126 to 132**

67



Towel Clamps
Handtuchklammern
Abrazaderas de toalla
Pinces à serviettes
Morsetti per asciugamano **Page 133 to 134**

68



Needle Holders
Nadelhalter
Porte-aiguilles
Porta-agujcs
Port' aghi **Page 135 to 143**

69



Retractors
Wundhaken
Ecarteurs
Separadores
Divaricatori **Page 144 to 148**

70



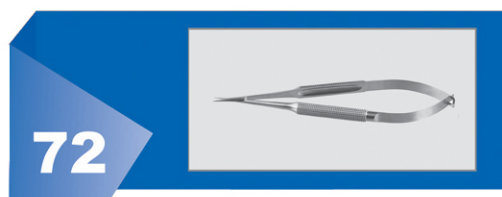
Mouth and Tongue
Mund und Zunge
Boca y la lengua
Bouche et langue
Bocca e la lingua **Page 149 to 152**



71

Scissors
Schere
Tijeras
Les ciseaux
Forbici

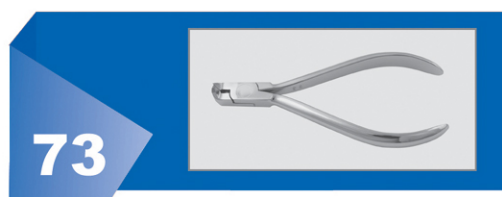
Page 153 to 171



72

Micro Scissors
Mikroschere
Micro tijeras
Micro-ciseaux
Micro forbici

Page 172 to 173



73

Orthodontics
Kieferorthopädie
Ortodoncia
Orthodontie
Ortodonzia

Page 174 to 190



74

Bone Rongeurs
Knochen Rongeur
Rongeurs de hueso
Os Rongeurs
Bone Rongeurs

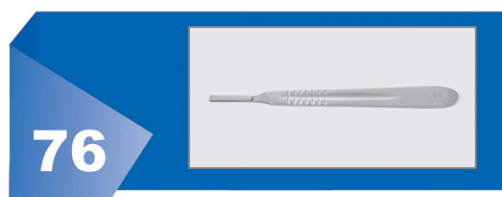
Page 191 to 193



75

Forceps
Zange
Fórceps
Forceps
forcipe

Page 194 to 201



76

Scalpel Handles
Skalpellgriffe
Manches de bistouris
Mangos de Bisturías
Manici per bisturi

Page 202 to 203



77

Mallets
Schlägel
Mazos
Maillets
Mallets

Page 204 to 206

78



Cassettes
Kassetten
Cassettes
Cassettes
cassette

Page 207 to 210

79



Cylinder cartridge syringe
Zylinder-Ampullenspritze
Seringue á ampoule cylindrique
Jeringo para cartucho ampollas
Siringe ampollare a cilindro

Page 211 to 216

80



Impression Trays
Abdrucklöffel
Porte empreintes
Cubetas para impresiones
Portaimpronte

Page 217 to 228

81



Articulators
Artikulatoren
Articuladores
Articulateurs
articolatori

Page 229 to 230

82



Holloware
Holloware
holloware
Platerie
Holloware

Page 231 to 234

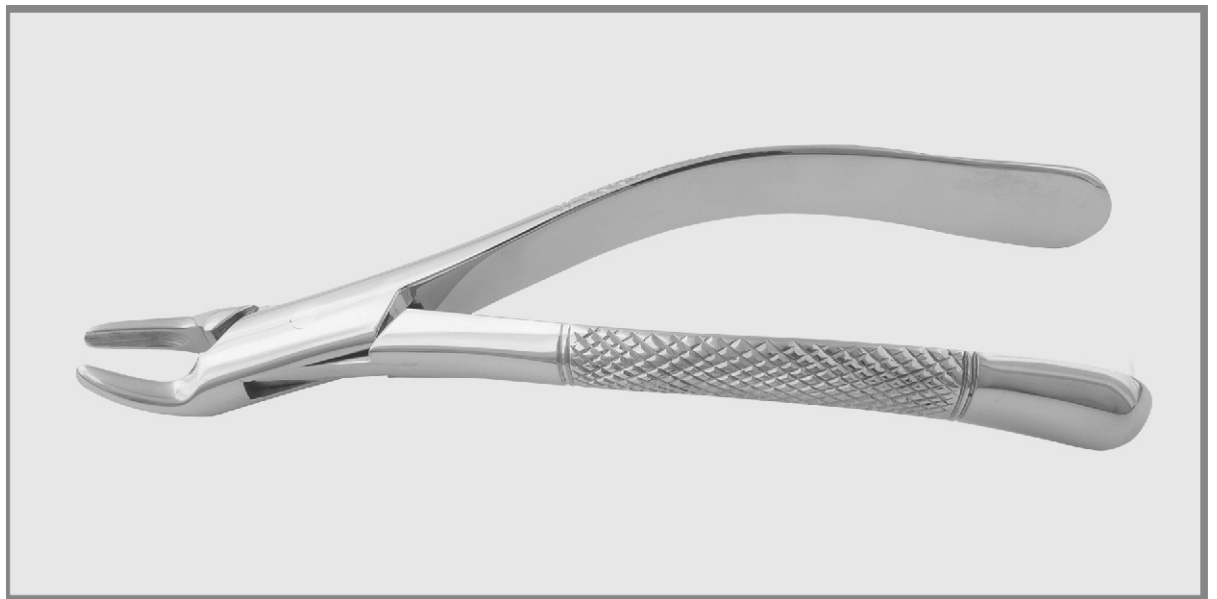


MOMAD DENTAL SUPPLIES

50

- EN** Extracting Forceps, American Pattern
- DE** Zahnzangen, Amerikanische Form
- ES** Daviers, forme américaine
- FR** Forceps de extraction, forma americana
- IT** Pinze per estrozione, forma americana

Page 01 to 15





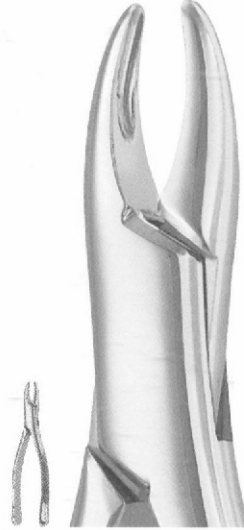
- EN —●— Extracting Forceps American Pattern
- DE —●— Extraktionszange amerikanisches Muster
- ES —●— Daviers, forme américaine
- FR —●— Forceps d'extraction modèle américain
- IT —●— Estrazione del forcipe modello americano



Fig. 1



HM-50-1001



HENAHAN
Fig. 1 A



HM-50-1002



Fig. 1 B



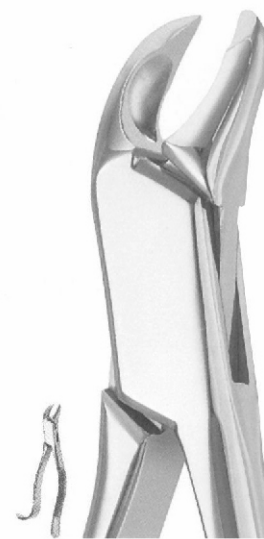
HM-50-1003



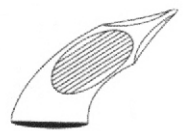
MILWAUKEE
Fig. 3



HM-50-1004



WOOD-WARD
Fig. 3 FH

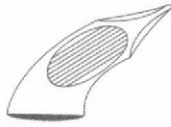


HM-50-1005



HM-50-1006

WOOD-WARD
 Fig. 3 FS



HM-50-1007

PHYSICK
 Fig. 5

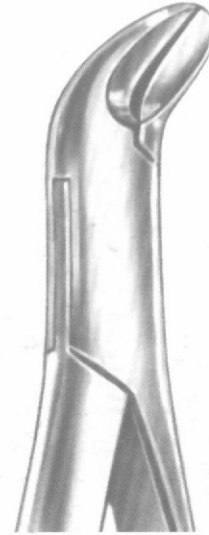
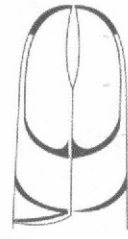
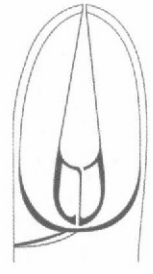


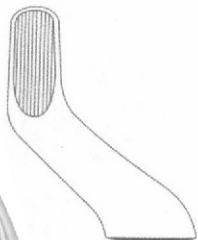
Fig. 6



HM-50-1008



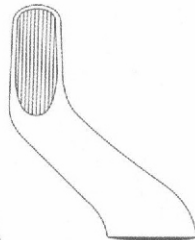
Fig. 10 H



HM-50-1009



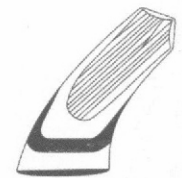
Fig. 10 S



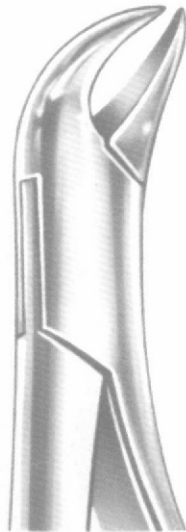
HM-50-1010



HARRIS
 Fig. 15



HM-50-1011



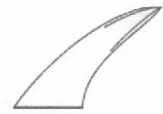
HARRIS
Fig. 16



HM-50-1012



Fig. 16 S



HM-50-1013



Fig. 17



HM-50-1014



HARRIS
Fig. 18 L



HM-50-1015



HARRIS
Fig. 18 R



HM-50-1016

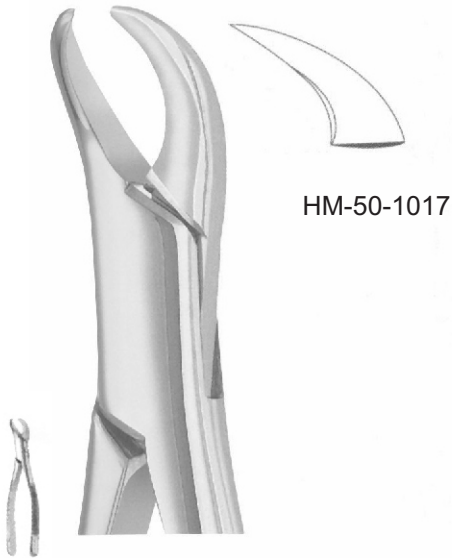


Fig. 23

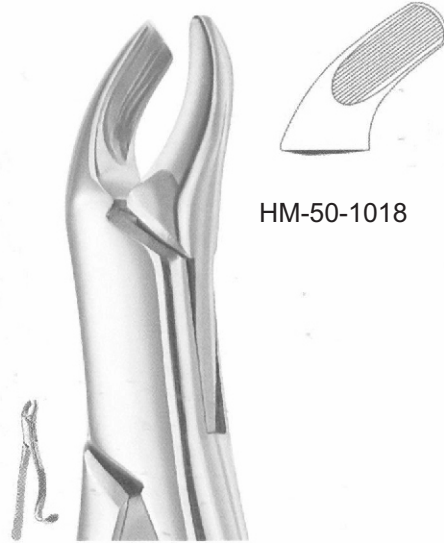


Fig. 24

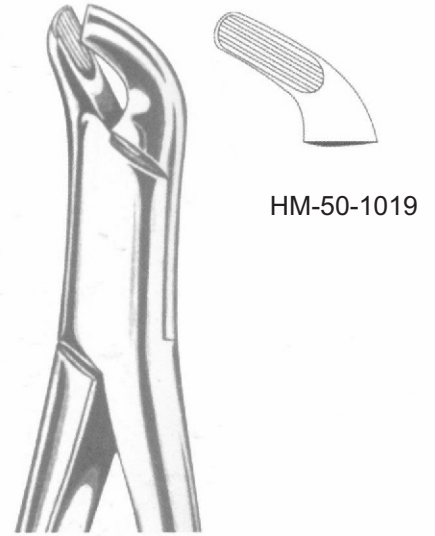
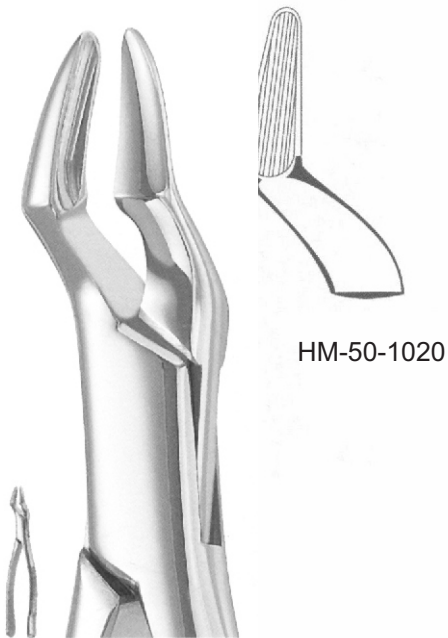
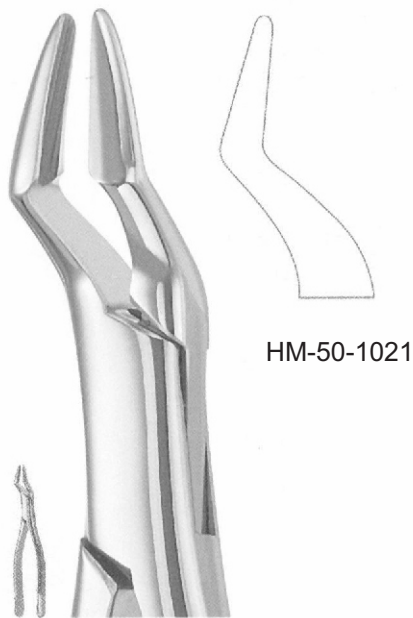


Fig. 27



PARMLY
 Fig. 32



PARMLY
 Fig. 32 A

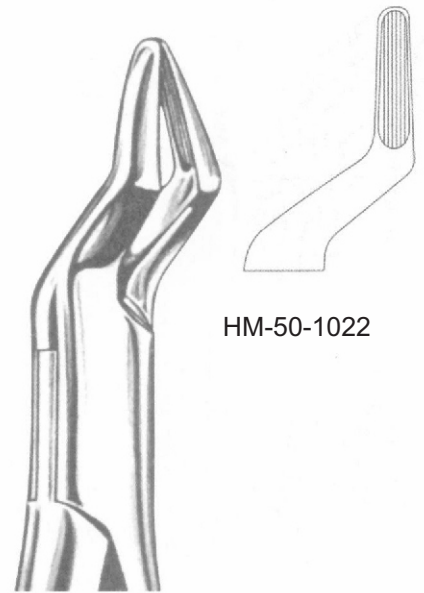


Fig. 35





HM-50-1023

Fig. 53 L



HM-50-1024

Fig. 53 R



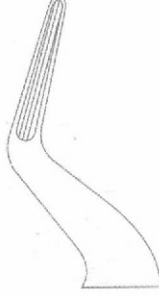
Fig. 62



HM-50-1025



Fig. 65



HM-50-1026



TOMES
 Fig. 69



HM-50-1027



THOMAS
 Fig. 85



HM-50-1028



THOMAS
 Fig. 85 A

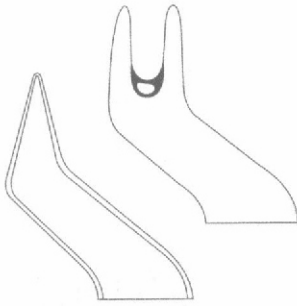


HM-50-1029





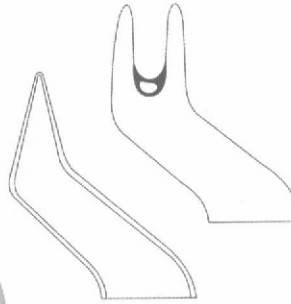
NEVIUS
Fig. 88 L



HM-50-1030



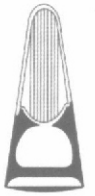
NEVIUS
Fig. 88 R



HM-50-1031



KELLS
Fig. 99 A



HM-50-1032



KELLS
Fig. 99 C



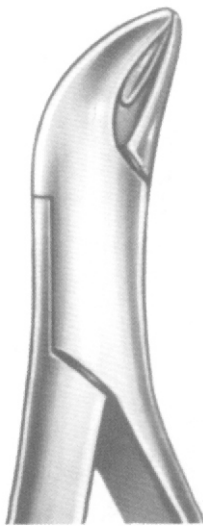
HM-50-1033



HULL
Fig. 101



HM-50-1034



HM-50-1035

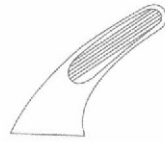


Fig. 103



HM-50-1036



Fig. 10 H



HM-50-1037



Fig. 10 S



HM-50-1038



CRYER
 Fig. 150



HM-50-1039



CRYER
 Fig. 150 A



HM-50-1040

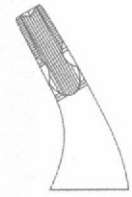
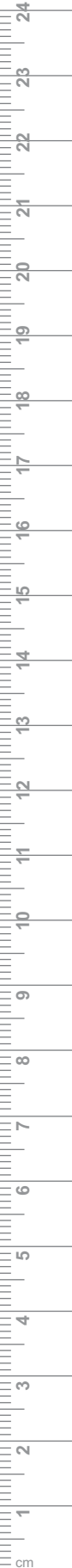
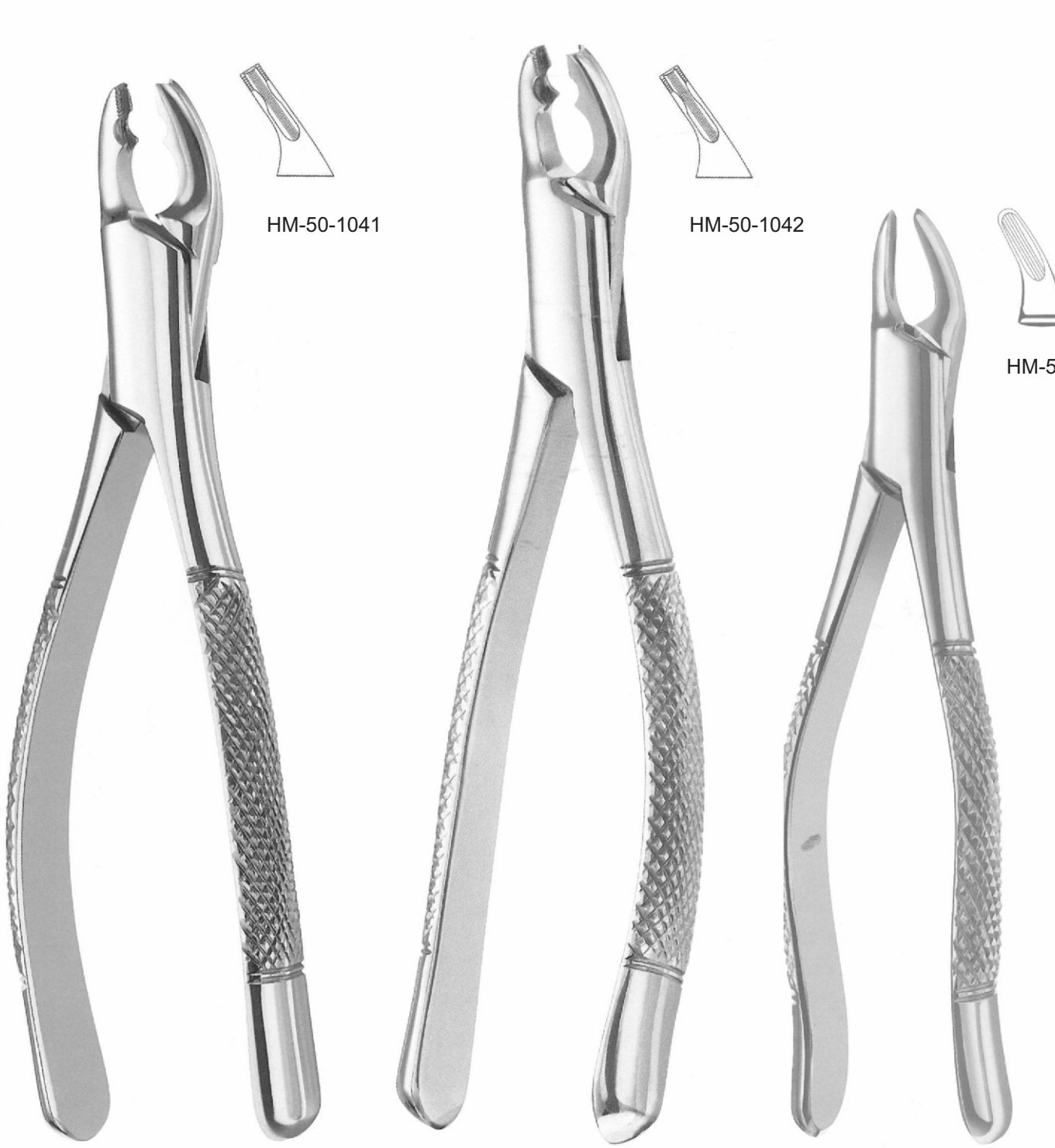


Fig. 150 X





HM-50-1041

HM-50-1042

HM-50-1043

Fig. 150 AB

Fig. 150 AS

CRYER
Fig. 150 S



CRYER
 Fig. 151

HM-50-1044



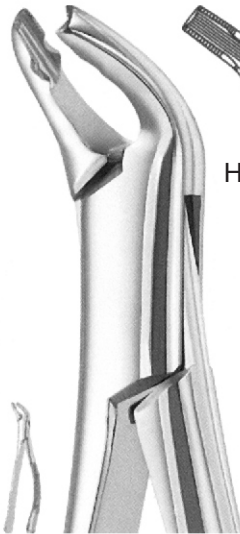
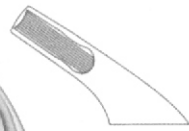
CRYER
 Fig. 151 A

HM-50-1045



Fig. 151 X

HM-50-1046



CRYER
 Fig. 151 AB

HM-50-1047

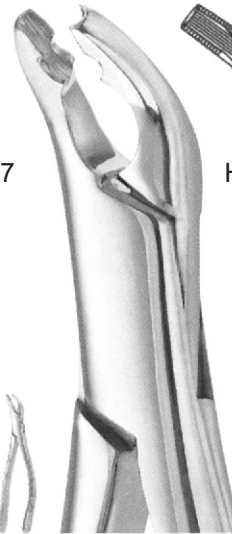
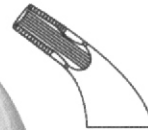


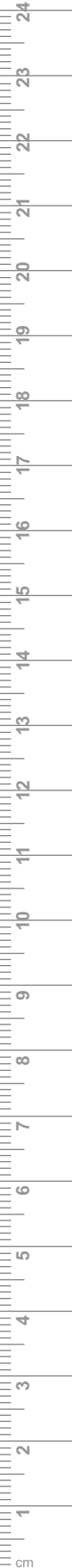
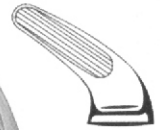
Fig. 151 AS

HM-50-1048



CRYER
 Fig. 151 S

HM-50-1049





- EN —●— Extracting Forceps American Pattern
- DE —●— Extraktionszange amerikanisches Muster
- ES —●— Daviers, forme américaine
- FR —●— Forceps d'extraction modèle américain
- IT —●— Estrazione del forcipe modello americano



HM-50-1056

Fig. 286



HM-50-1057

Fig. 288

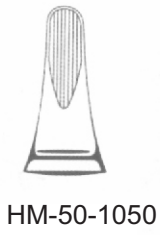


HM-50-1058

Fig. 287



Fig.201



HM-50-1050

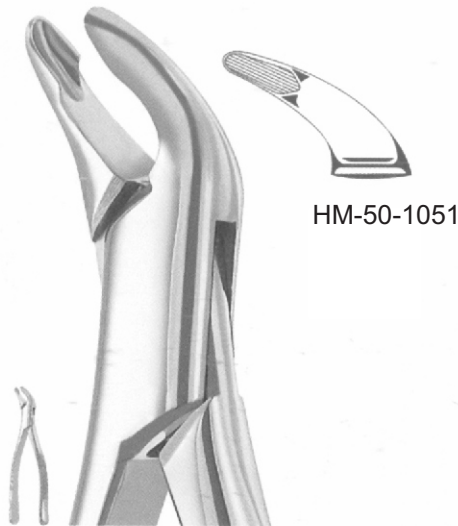
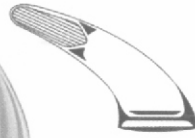


Fig.203



HM-50-1051



Fig.217



HM-50-1052



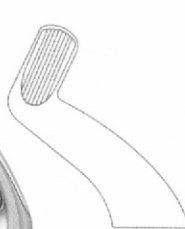
Fig.210 H



HM-50-1053



Fig.210 S



HM-50-1054



Fig.222

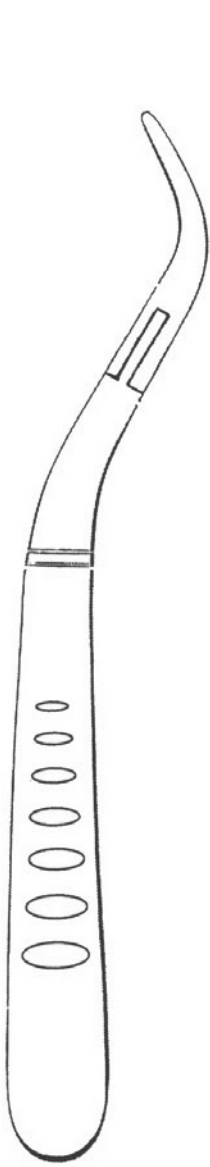


HM-50-1055

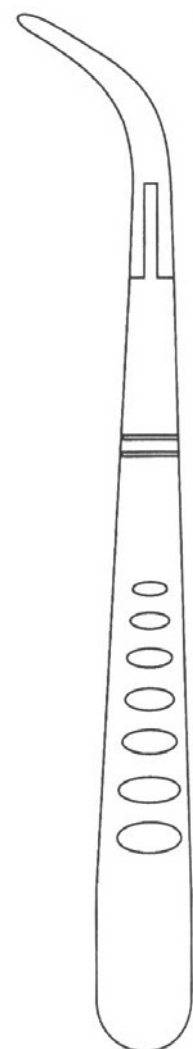




- EN —●— Extracting Forceps American Pattern
- DE —●— Extraktionszange amerikanisches Muster
- ES —●— Daviers, forme américaine
- FR —●— Forceps d'extraction modèle américain
- IT —●— Estrazione del forcipe modello americano



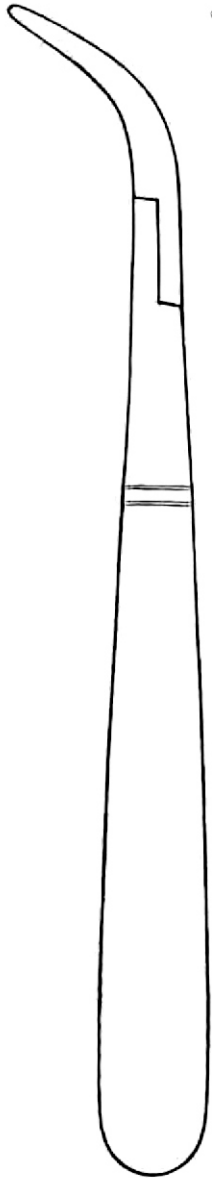
HM-50-1059



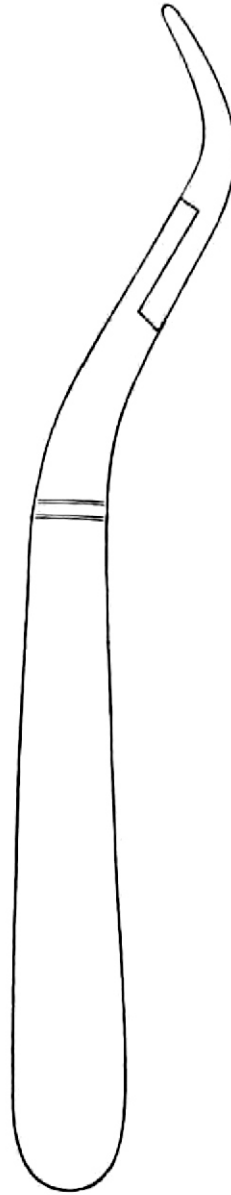
HM-50-1060

Fig.300

Fig.301



HM-50-1061
 WITZEL
 Fig.501



HM-50-1062
 WITZEL
 Fig.502





HM-50-1063

Fig. 17 SK



HM-50-1064

Fig. 23 SK



HM-50-1065

Fig. 150 Sk



HM-50-1066

Fig. 151 Sk

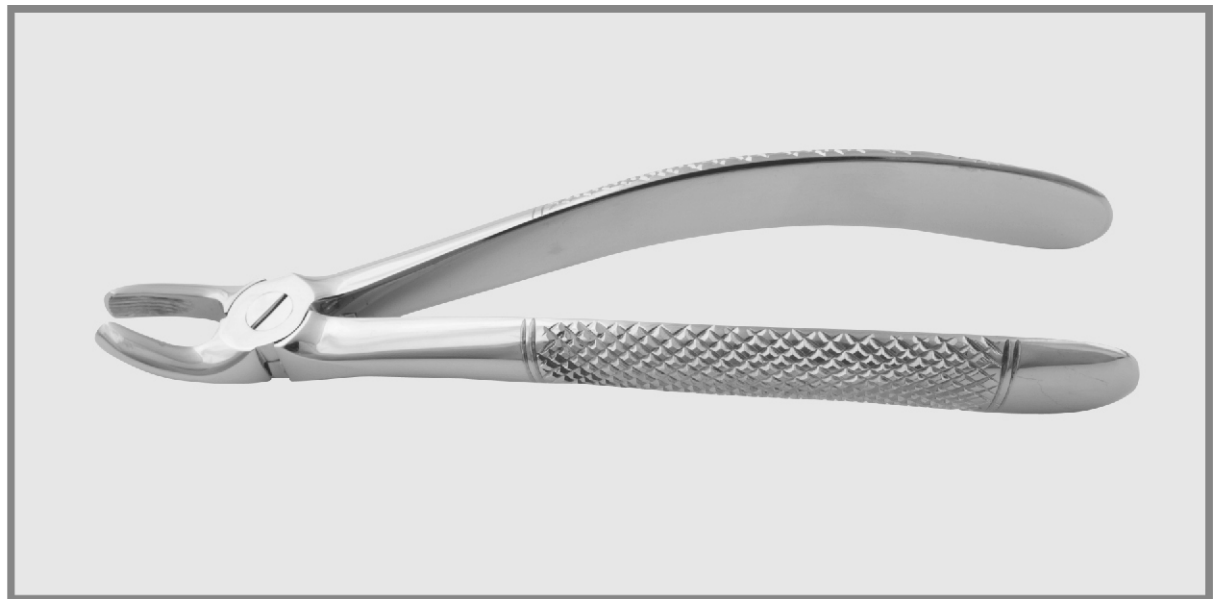


MOMAD DENTAL SUPPLIES

51

- EN** Extracting forceps, English pattern
- DE** Zahnzangen, Englische Form
- ES** Daviers, forme anglaise
- FR** Fórceps dentales, forma inglesa
- IT** Pinze per estrazione, forma inglese

Page 16 - 39





- EN —●— Extracting forceps, English pattern
- DE —●— Zahnzangen, Englische Form
- ES —●— Daviers, forme anglaise
- FR —●— Fôrceps dentales, forma inglesa
- IT —●— Pinze per estrazione, forma inglese



Fig. 1



HM-51-1101



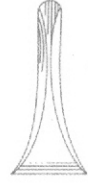
Fig. 2



HM-51-1102



Fig. 3



HM-51-1103

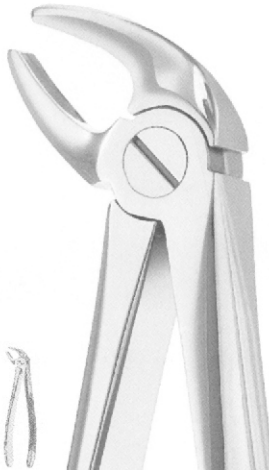
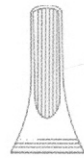


Fig. 4



HM-51-1104



Fig. 7



HM-51-1105



HM-51-1106

Fig. 8



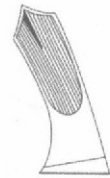
HM-51-1107

Fig. 13



HM-51-1108

Fig. 17



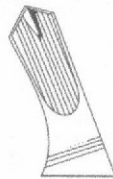
HM-51-1109

Fig. 18



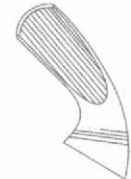
HM-51-1110

Fig. 18 A



HM-51-1111

Fig. 19

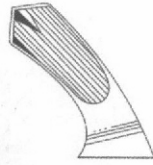




- EN —●— Extracting forceps, English pattern
- DE —●— Zahnzangen, Englische Form
- ES —●— Daviers, forme anglaise
- FR —●— Fôrceps dentales, forma inglesa
- IT —●— Pinze per estrazione, forma inglese



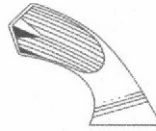
Fig. 20



HM-51-1112



Fig. 21



HM-51-1113



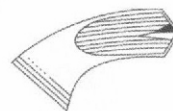
Fig. 22



HM-51-1114



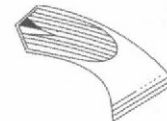
Fig. 23



HM-51-1115



Fig. 24



HM-51-1116



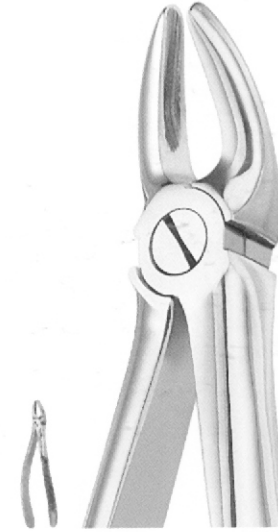
HM-51-1117

Fig. 29



HM-51-1118

Fig. 29 N

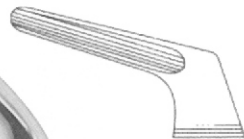


HM-51-1119

Fig. 30



Fig. 31



HM-51-1120



Fig. 32
 HM-51-1121





- EN —●— Extracting forceps, English pattern
- DE —●— Zahnzangen, Englische Form
- ES —●— Daviers, forme anglaise
- FR —●— Férceps dentales, forma inglesa
- IT —●— Pinze per estrazione, forma inglese

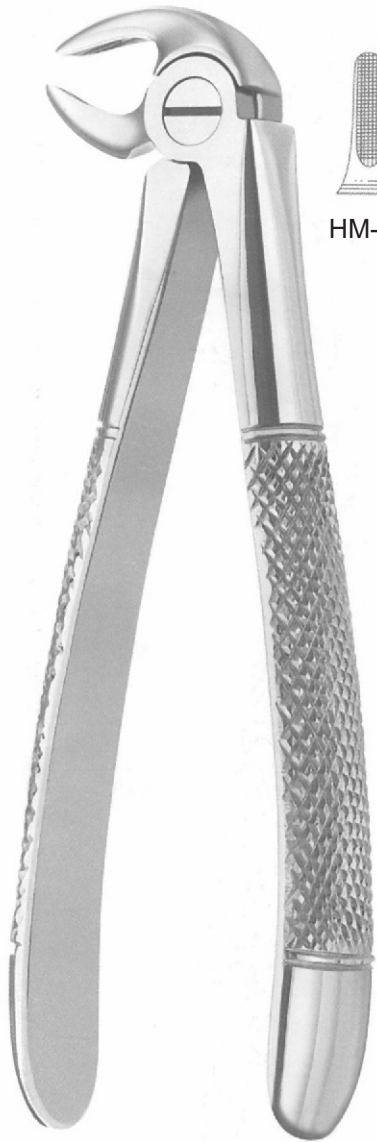
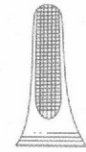


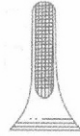
Fig. 33



HM-51-1122



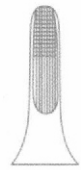
Fig. 33 A



HM-51-1123



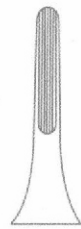
Fig. 33 C



HM-51-1124



Fig. 33 M



HM-51-1125



Fig. 33 W



HM-51-1126



HM-51-1127

Fig. 34



HM-51-1128

Fig. 35



HM-51-1129

Fig. 36





- EN —●— Extracting forceps, English pattern
- DE —●— Zahnzangen, Englische Form
- ES —●— Daviers, forme anglaise
- FR —●— Fórceps dentales, forma inglesa
- IT —●— Pinze per estrazione, forma inglese



Fig. 41



HM-51-1130



Fig. 44



HM-51-1131



Fig. 44 F



HM-51-1132



Fig. 45



HM-51-1133



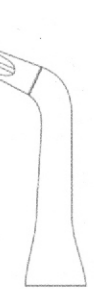
Fig. 45 F



HM-51-1134



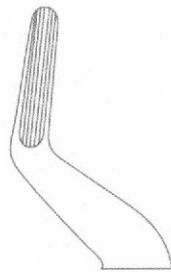
Fig. 46 L



HM-51-1135



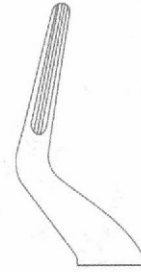
Fig. 51



HM-51-1136



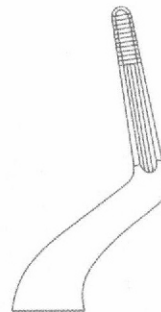
Fig. 51 A



HM-51-1137



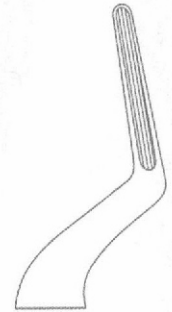
Fig. 51 C



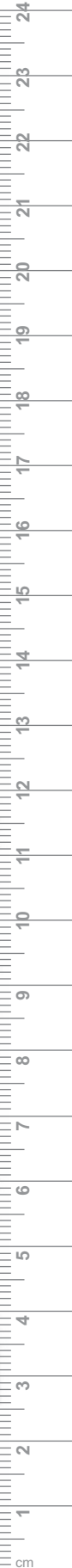
HM-51-1138



Fig. 51 L



HM-51-1139



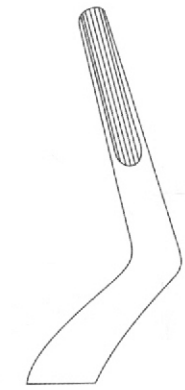


- EN —●— Extracting forceps, English pattern
- DE —●— Zahnzangen, Englische Form
- ES —●— Dáviers, forme anglaise
- FR —●— Fórceps dentales, forma inglesa
- IT —●— Pinze per estrazione, forma inglese

MOMAD DENTAL SUPPLIES



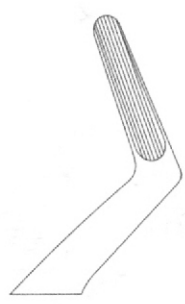
Fig. 51 M



HM-51-1140



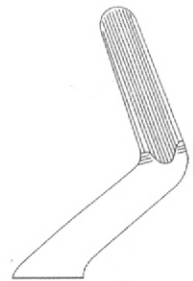
Fig. 52



HM-51-1141



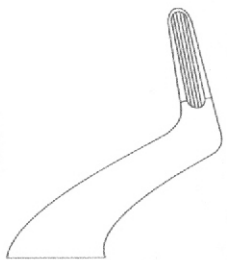
Fig. 52 A



HM-51-1142



Fig. 53



HM-51-1143



Fig. 55



HM-51-1144

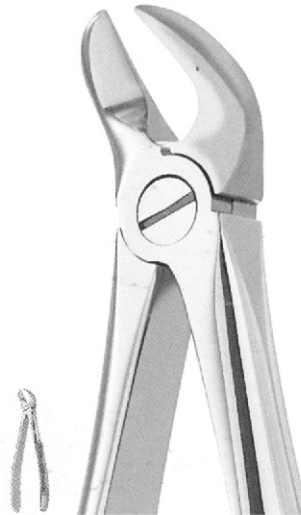
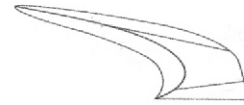
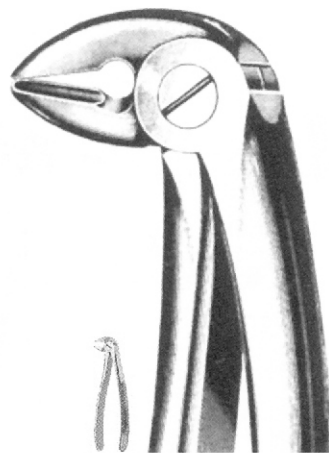


Fig. 56



HM-51-1145



BUSCH
Fig. 59

breit
broad



HM-51-1146

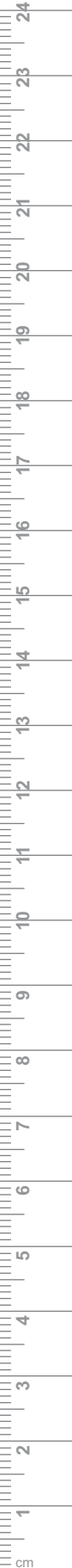


BUSCH
Fig. 60

schmal
narrow



HM-51-1147





- EN —●— Extracting forceps, English pattern
- DE —●— Zahnzangen, Englische Form
- ES —●— Daviers, forme anglaise
- FR —●— Fórceps dentales, forma inglesa
- IT —●— Pinze per estrazione, forma inglese



HM-51-1148

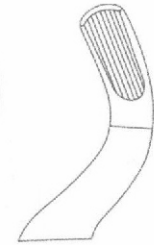


Fig. 67



HM-51-1149



Fig. 67 A



HM-51-1150

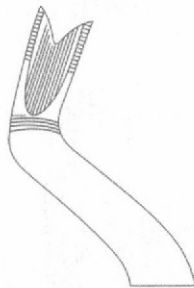


Fig. 67 LX



HM-51-1151

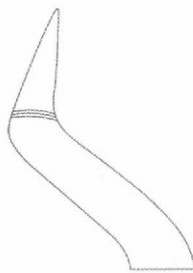
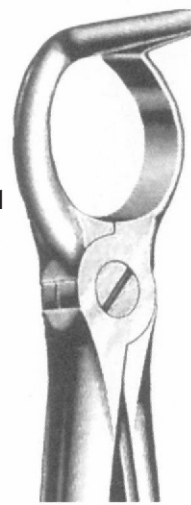
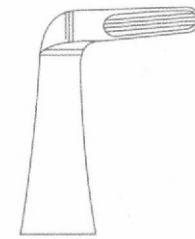


Fig. 67 RX



RYDING
Fig. 68



HM-51-1152



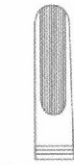
Fig. 73



HM-51-1153



Fig. 74



HM-51-1154

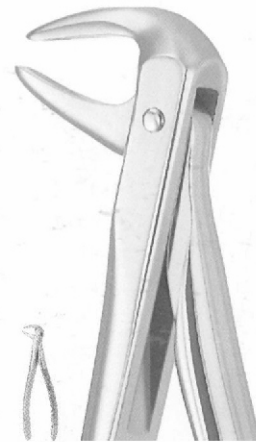


Fig. 74 M



HM-51-1155

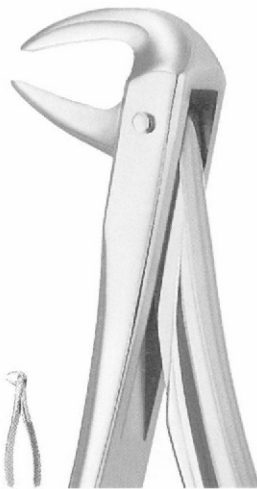


Fig. 74N



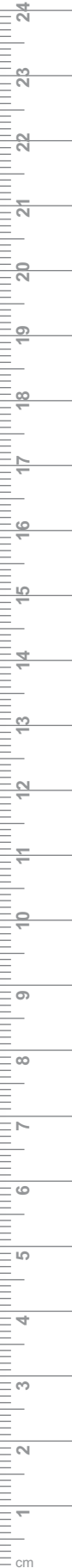
HM-51-1156



Fig. 75

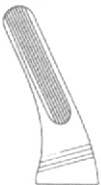


HM-51-1157





- EN —●— Extracting forceps, English pattern
- DE —●— Zahnzangen, Englische Form
- ES —●— Dáviers, forme anglaise
- FR —●— Fórceps dentales, forma inglesa
- IT —●— Pinze per estrazione, forma inglese



HM-51-1158

LAWRENCE-READ
Fig. 76

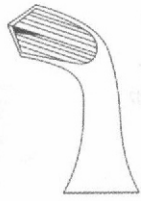


HM-51-1159

LAWRENCE-READ
Fig. 76 N



Fig. 79



HM-51-1160

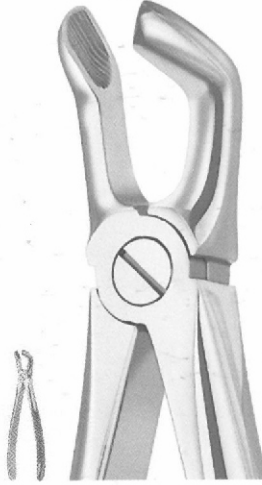
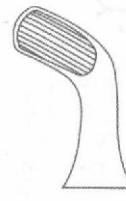


Fig. 79 A



HM-51-1161



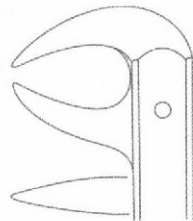
Fig. 86 A



HM-51-1162



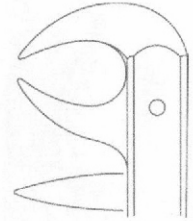
Fig. 86 B



HM-51-1163



Fig. 86 C



HM-51-1164

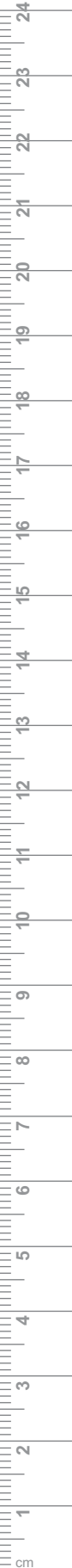




Fig. 87



Fig. 89

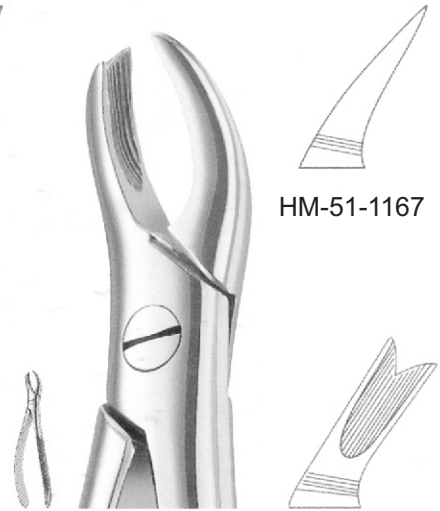


Fig. 90



Fig. 94



Fig. 95



WOOD
Fig. 99



Fig. 113
HM-51-1171



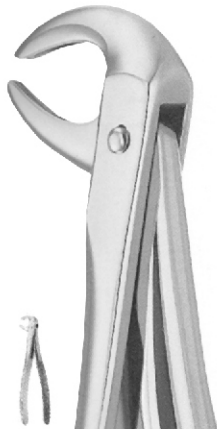
OGDEN FELSCH
Fig. 121



HM-51-1172



GUY
Fig. 136
HM-51-1173



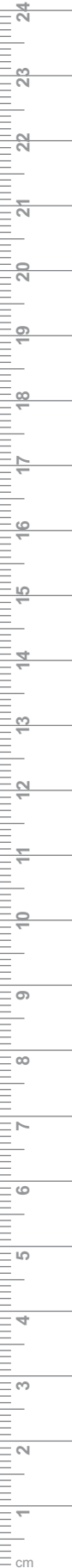
GUY
Fig. 137
HM-51-1174



Fig. 160
HM-51-1175



Fig. 162
HM-51-1176





- EN —●— Extracting forceps, English pattern
- DE —●— Zahnzangen, Englische Form
- ES —●— Daviers, forme anglaise
- FR —●— Fórceps dentales, forma inglesa
- IT —●— Pinze per estrazione, forma inglese



HM-51-1177
Fig. 233



HM-51-1178



HM-51-1179
Fig. 235



MEAD
Fig. MD 1



HM-51-1180



MEAD
Fig. MD 2



HM-51-1181



MEAD
Fig. MD 3



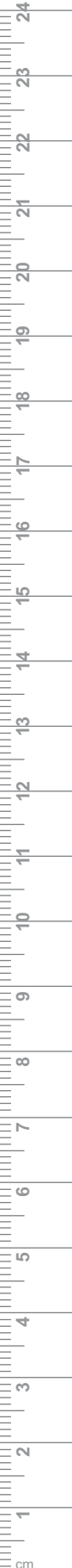
HM-51-1182



MEAD
Fig. MD 4



HM-51-1183





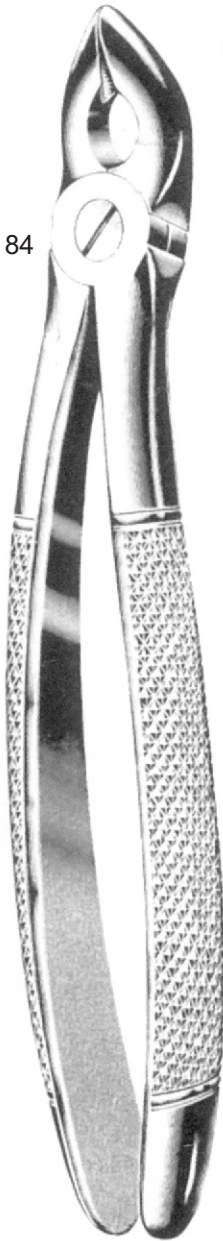
- EN —●— Extracting forceps, English pattern
- DE —●— Zahnzangen, Englische Form
- ES —●— Daviers, forme anglaise
- FR —●— Fórceps dentales, forma inglesa
- IT —●— Pinze per estrazione, forma inglese



COHEN



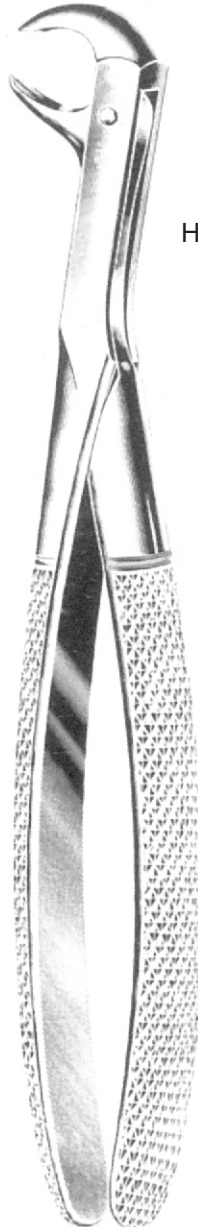
HM-51-1184



COHEN



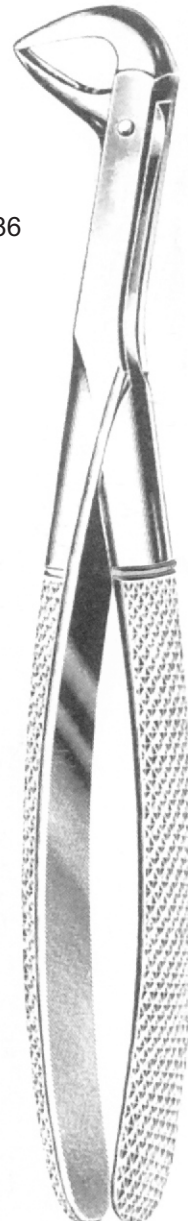
HM-51-1185



STIKSA



HM-51-1186



STIKSA



HM-51-1187

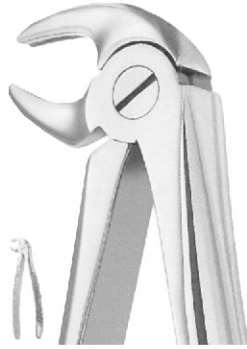


Fig. 13 S



Fig. 22 S

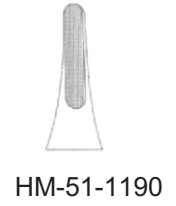


Fig. 29 S

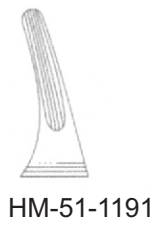


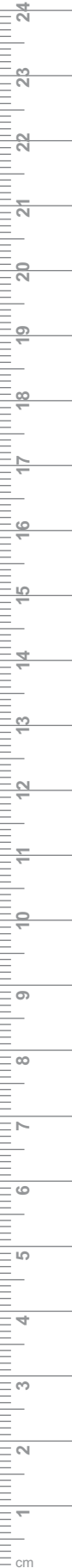
Fig. 30 S



Fig. 33 S



Fig. 37





- EN —●— Extracting forceps, English pattern
- DE —●— Zahnzangen, Englische Form
- ES —●— Dáviers, forme anglaise
- FR —●— Fórceps dentales, forma inglesa
- IT —●— Pinze per estrazione, forma inglese



Fig. 38



HM-51-1194



Fig. 39



HM-51-1195

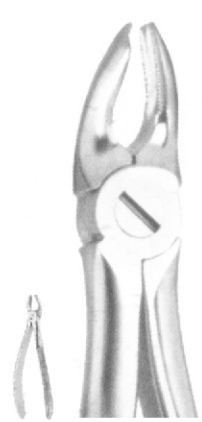


Fig. 39 A



HM-51-1196



Fig. 39 L



HM-51-1197



Fig. 39 R



HM-51-1198



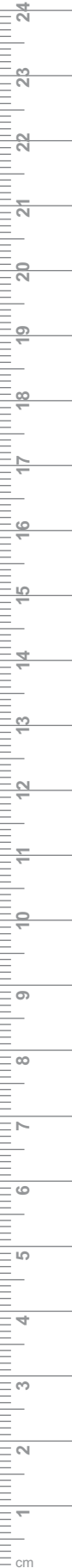
Fig. 40

HM-51-1199

Fig. 51 S

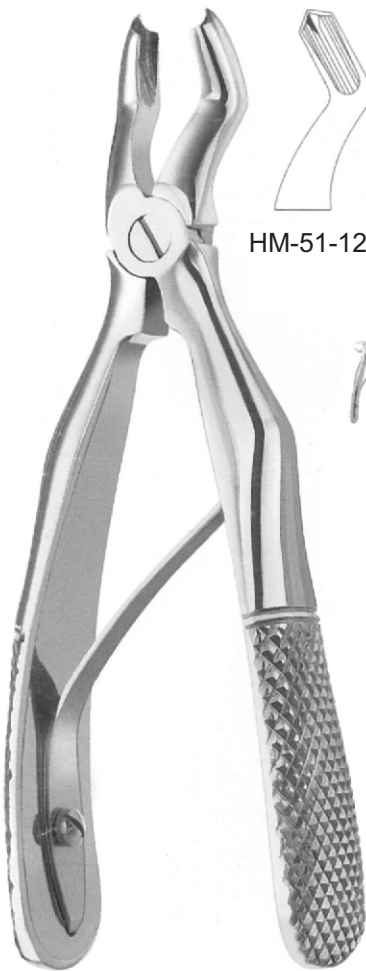
HM-51-1200

HM-51-1201
 LAWRENCE-READ
 Fig. 76 S





- EN —●— Extracting Forceps Kids, English Pattern
- DE —●— Zange-Zangen extrahieren, englisches Muster
- ES —●— Extracción de fórceps para niños, patrón inglés
- FR —●— Forceps d'extraction enfants, modèle anglais
- IT —●— Estrazione di forcipi per bambini, modello inglese



KLEIN
Fig. 3



HM-51-1202



HM-51-1203

Fig. 5



HM-51-1204

Fig. 6



HM-51-1205

Fig. 7



HM-51-1206

KLEIN
 Fig. 137



HM-51-1207

KLEIN
 Fig. 139



HM-51-1208

KLEIN
 Fig. 51 S



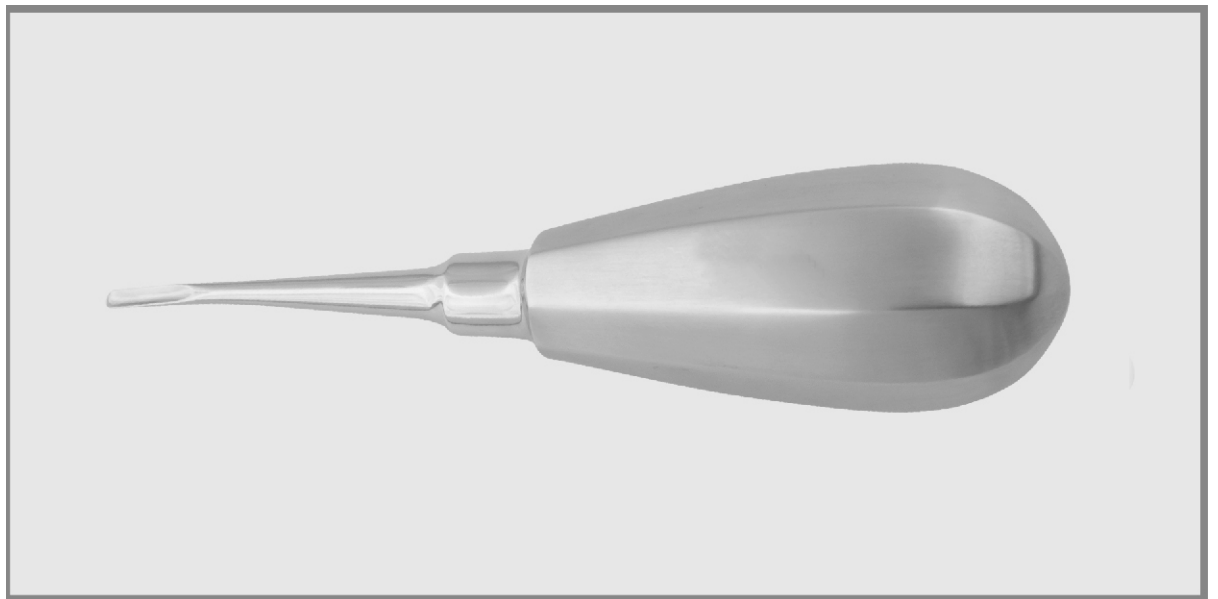


MOMAD DENTAL SUPPLIES

52

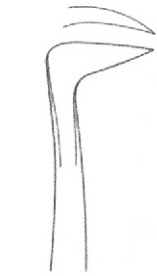
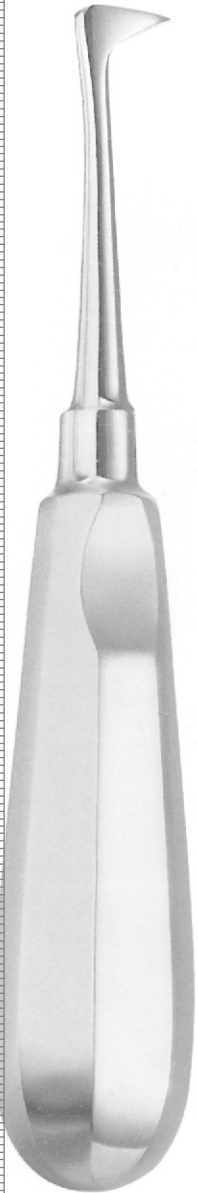
- EN** Root Elevators
- DE** Wurzelheber
- ES** Elevateurs á racines
- FR** Botadores para raíces
- IT** Leve per radici

Page 40 to 54





- EN —●— Root Elevators
- DE —●— Wurzelauflüge
- ES —●— Elevadores De Raíz
- FR —●— Élévateurs De Racines
- IT —●— Elevatori Di Root



HM-52-1251
Fig. 1 L



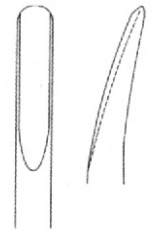
HM-52-1252
Fig. 1 R



SALDIN
HM-52-1253
Fig. 2



SELDIN
HM-52-1254
Fig. 3



CRYER
HM-52-1255
Fig. 3 A



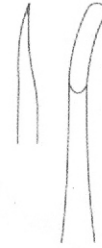
SELDIN
HM-52-1256
Fig. 4 L



SELDIN
HM-52-1257
Fig. 4 R



CRANE
(COGSWELL)
HM-52-1258
Fig. 6



MILLER
HM-52-1259
Fig. 8



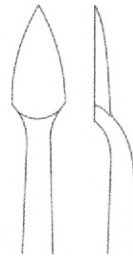
MILLER
HM-52-1260
Fig. 9



MILLER (Apexo)
HM-52-1261
Fig. 10



MILLER (Apexo)
HM-52-1262
Fig. 11



CRYER
HM-52-1263
Fig. 12



CRYER
 HM-52-1264
 Fig. 27



CRYER
 HM-52-1265
 Fig. 28



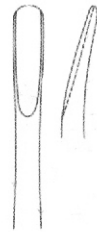
CRYER
 HM-52-1266
 Fig. 27 S



CRYER
 HM-52-1267
 Fig. 28 S



SELDIN
 HM-52-1268
 Fig. 34



SELDIN
 HM-52-1269
 Fig. 34 S



CRYER
 HM-52-1270
 Fig. 39



CRYER
 HM-52-1271
 Fig. 40



FLOHR
 HM-52-1272
 Fig. 46



HM-52-1273
 Fig. 50



HM-52-1274
 Fig. 51





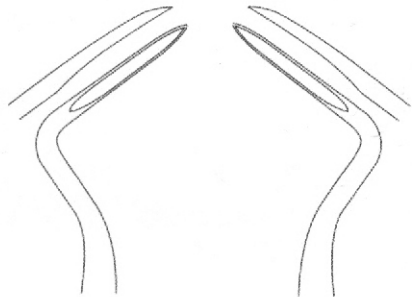
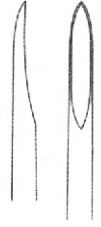
- EN —●— Root Elevators
- DE —●— Wurzelauflüge
- ES —●— Elevadores De Raíz
- FR —●— Élévateurs De Racines
- IT —●— Elevatori Di Root



APICAL (Apexo)
HM-52-1275
Fig. 301



HM-52-1276
Fig. 304

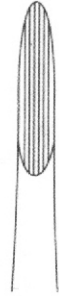


HM-52-1277
Fig. 302

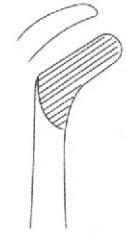
FLOHR
HM-52-1278
Fig. 303



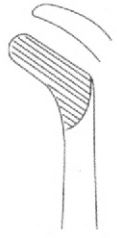
COLEMAN



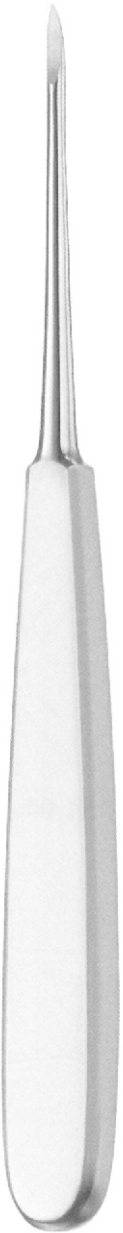
HM-52-1279
Fig. 1



HM-52-1280
Fig. 2 L



HM-52-1281
Fig. 3 R



WARWICK JAMES
 HM-52-1282
 16 cm/6 1/4"



HM-52-1283
 Fig. 2 L



HM-52-1284
 Fig. 3 L



KOPP



HM-52-1285
 Fig. 1



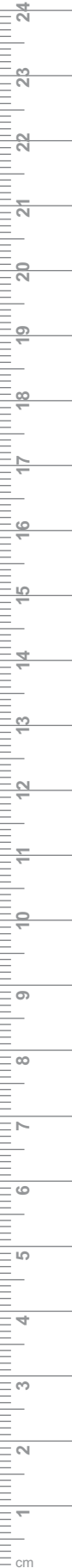
HM-52-1286
 Fig. 2



HM-52-1287
 Fig. 3



HM-52-1288
 Fig. 4





KOPP



HM-52-1289
Fig. 1



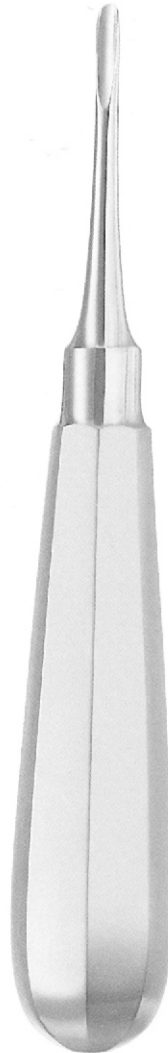
HM-52-1290
Fig. 2



HM-52-1291
Fig. 3



HM-52-1292
Fig. 4



FLOHR



HM-52-1293
Fig. 1



HM-52-1294
Fig. 2



HM-52-1295
Fig. 3



FRIEDMAN
 HM-52-1296
 Fig 1



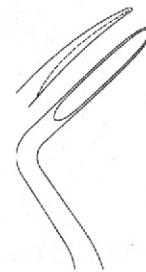
HM-52-1297
 Fig. 2 L



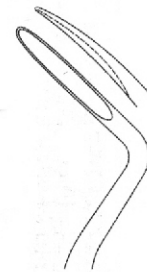
HM-52-1298
 Fig. 3 R



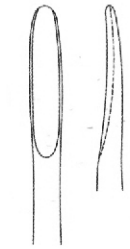
HYLIN
 HM-52-1299
 Fig. 1



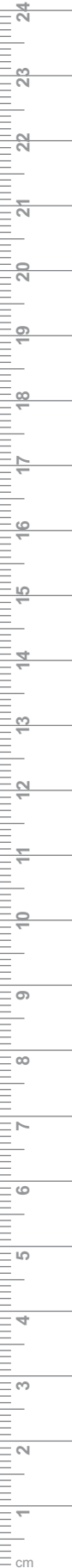
HM-52-1301
 Fig. 3 L



HM-52-1302
 Fig. 4 R



HM-52-1300
 Fig. 2

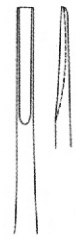




- EN —●— Root Elevators
- DE —●— Wurzelauflzüge
- ES —●— Elevadores De Raíz
- FR —●— Élévateurs De Racines
- IT —●— Elevatori Di Root

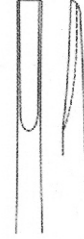


2 mm



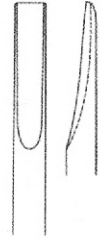
HM-52-1303
Fig.0

3 mm



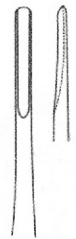
BEIN
HM-52-1304
Fig. 1

4 mm



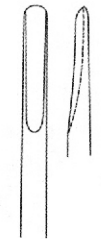
HM-52-1305
Fig. 2

2 mm



HM-52-1306
Fig. 0

3 mm



BEIN
HM-52-1307
Fig. 1

4 mm



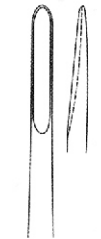
HM-52-1308
Fig. 2

2 mm



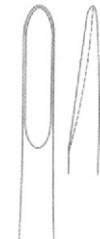
HM-52-1309
Fig. 0

3 mm



BEIN
HM-52-1310
Fig. 1

4 mm



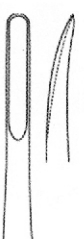
HM-52-1311
Fig. 2

2 mm



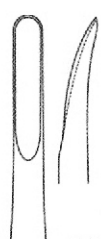
HM-52-1312
Fig. 0 A

3mm



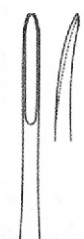
BEIN
HM-52-1313
Fig. 1 A

4 mm



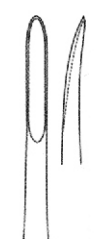
HM-52-1314
Fig.2 A

2 mm



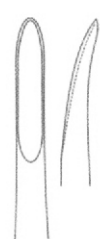
HM-52-1315
Fig.0 A

3 mm

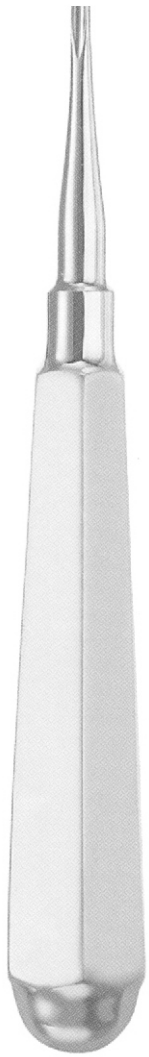


BEIN
HM-52-1316
Fig. 1 A

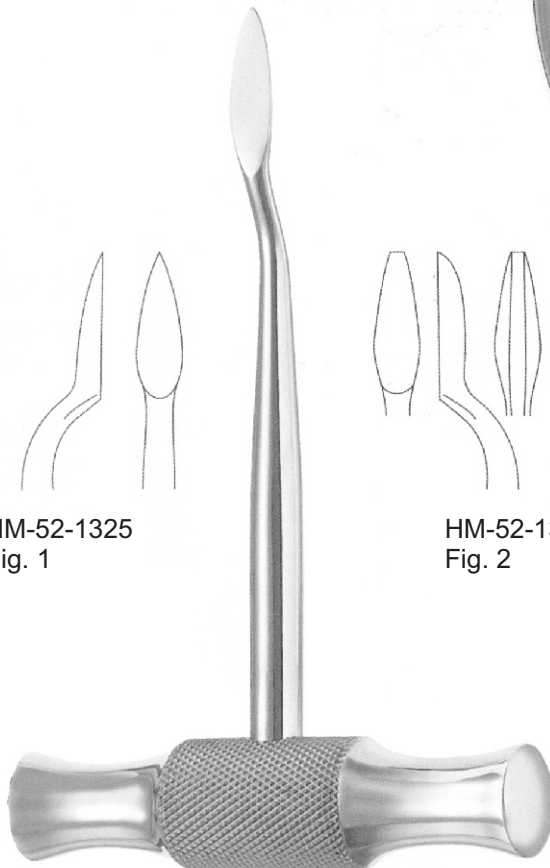
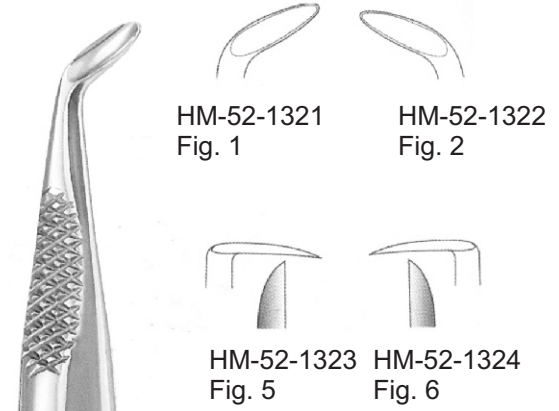
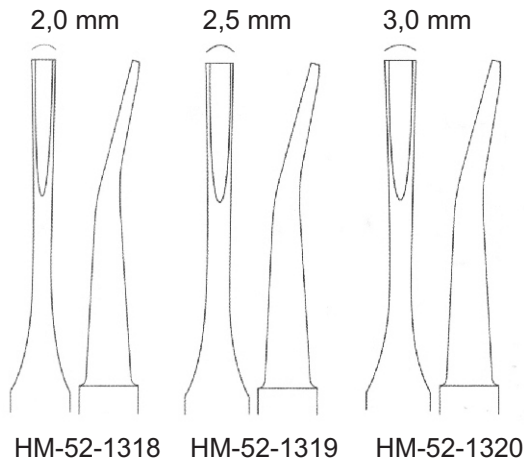
4 mm



HM-52-1317
Fig. 2 A



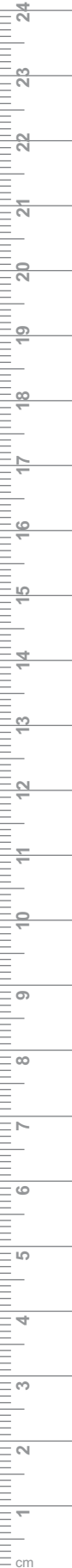
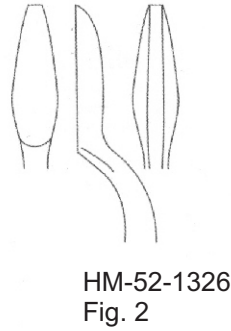
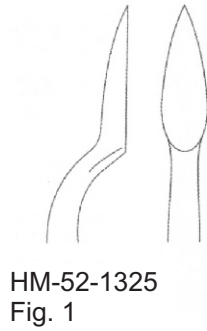
COUPLAND



LECLUSE



LOOS





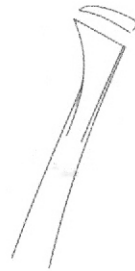
- EN ● Root Elevators
- DE ● Wurzelauflüge
- ES ● Elevadores De Raíz
- FR ● Élévateurs De Racines
- IT ● Elevatori Di Root



BARRY
11 cm/4 1/4"



HM-52-1327
Fig. 320 L



HM-52-1328
Fig. 321 R



HM-52-1329
Fig. 322



HM-52-1330
Fig. 323



HM-52-1331
Fig. 370



HM-52-1332
Fig.371



HM-52-1333
Fig. 1 L



HM-52-1334
Fig. 1 R



HM-52-1335
Fig. 11 L



HM-52-1336
Fig. 11 R



HM-52-1337
Fig. 12 L



HM-52-1338
Fig. 12 R



WINTER
11 cm/4 1/4"



HM-52-1339
Fig. 13 L



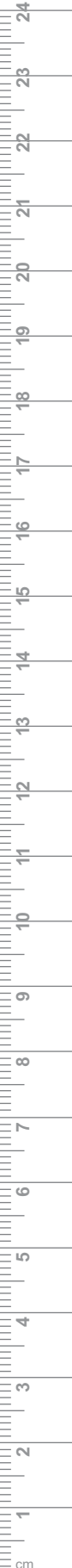
HM-52-1340
Fig. 13 R



HM-52-1341
Fig. 14 L



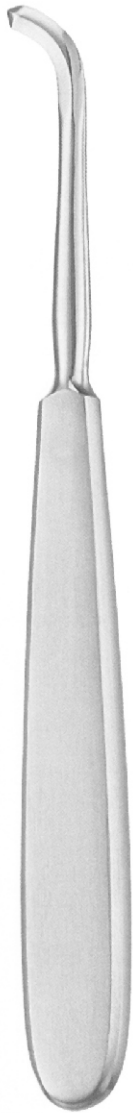
HM-52-1342
Fig. 14 R





- EN —●— Root Elevators
- DE —●— Wurzelauflzüge
- ES —●— Elevadores De Raíz
- FR —●— Élévateurs De Racines
- IT —●— Elevatori Di Root

MOMAD DENTAL SUPPLIES



CHOMPRET



HM-52-1343
Fig. 1



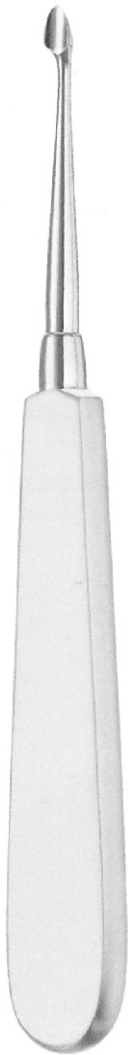
HM-52-1344
Fig. 2



HM-52-1345
Fig. 3



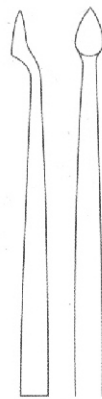
HM-52-1346
Fig. 4



BERNARD



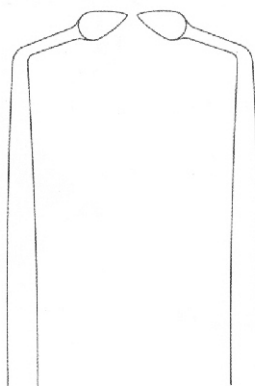
HM-52-1347
Fig. 0



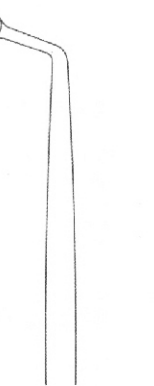
HM-52-1348
Fig. 1



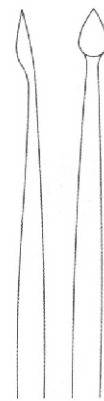
HM-52-1349
Fig. 2



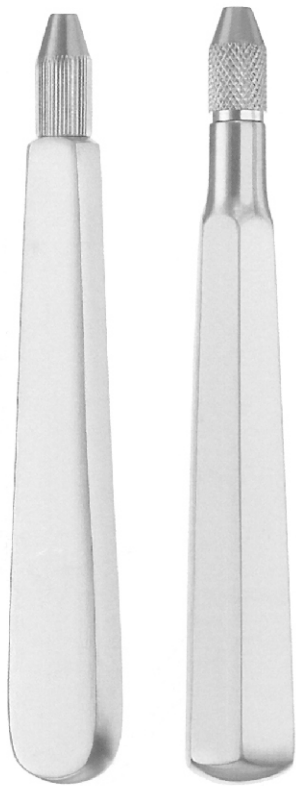
HM-52-1350
Fig. 6



HM-52-1351
Fig. 7

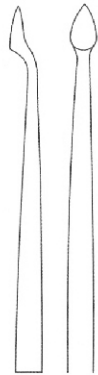


HM-52-1352
Fig. 11



BERNARD
Handle # A

BERNARD
Handle # B



HM-52-1353
Fig. 1



HM-52-1354
Fig. 2



HM-52-1355
Fig. 3



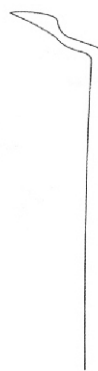
HM-52-1356
Fig. 4



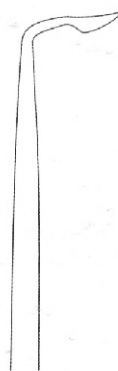
HM-52-1357
Fig. 5



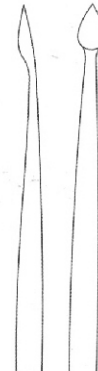
HM-52-1358
Fig. 10



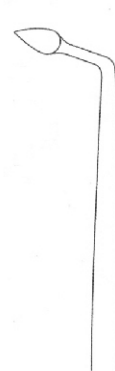
HM-52-1359
Fig. 8



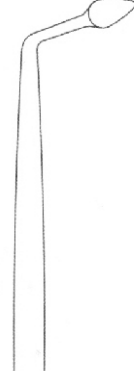
HM-52-1360
Fig. 9



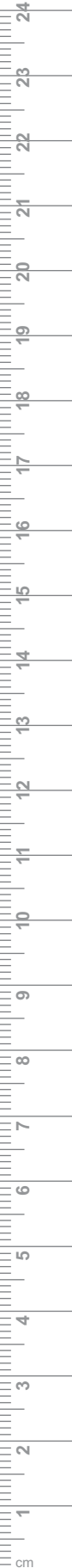
HM-52-1361
Fig. 11



HM-52-1362
Fig. 7

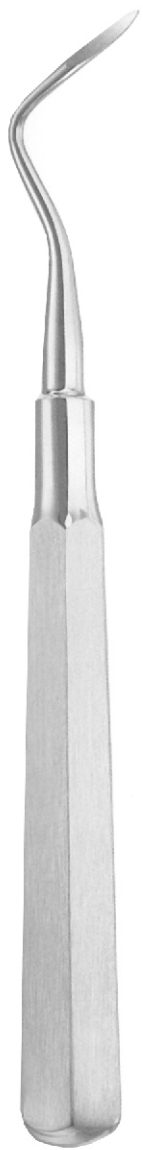


HM-52-1363
Fig. 6

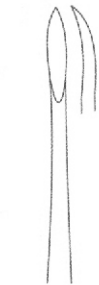




- EN —●— Root Elevators
- DE —●— Wurzelauflüge
- ES —●— Elevadores De Raíz
- FR —●— Élévateurs De Racines
- IT —●— Elevatori Di Root



HEIDBRINK



HM-52-1366
Fig. 1



HM-52-1367
Fig. 2



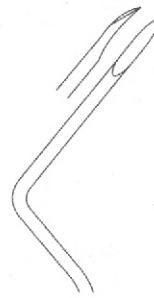
HM-52-1368
Fig. 3



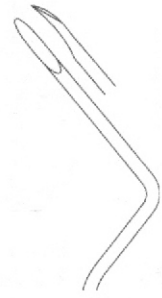
WEST (Apical)



HM-52-1369
Fig. 1



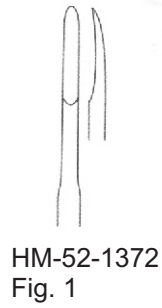
HM-52-1370
Fig. 2 R



HM-52-1371
Fig. 3 L



RATZOW



HM-52-1372
Fig. 1



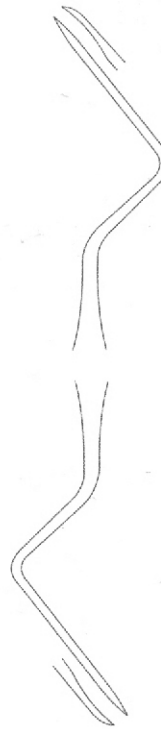
HM-52-1373
Fig. 2



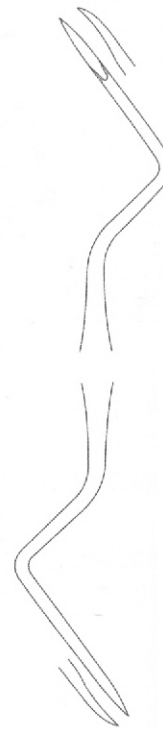
HM-52-1374
Fig. 3



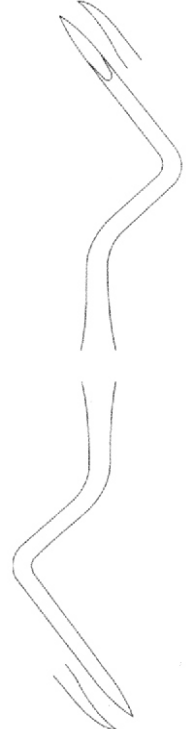
HEIDBRINK



HM-52-1375
Fig. 1



HM-52-1376
Fig. 2

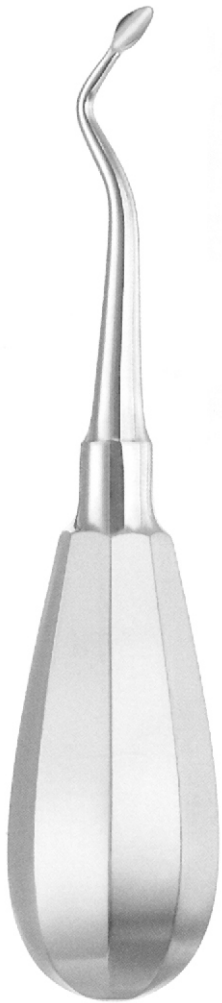


HM-52-1377
Fig. 23

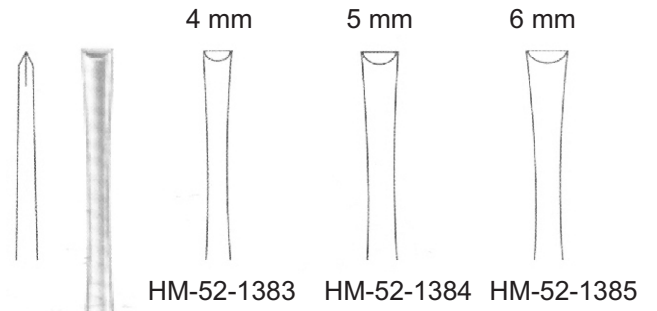
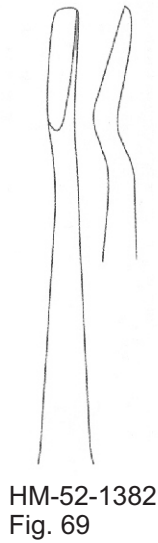
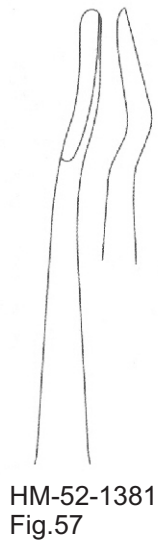
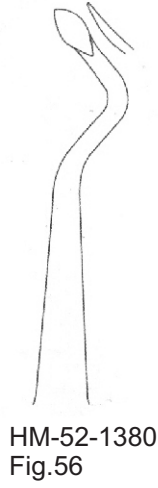
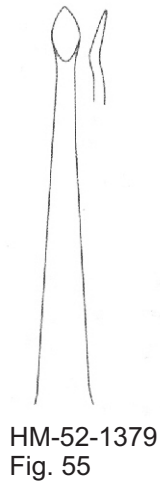
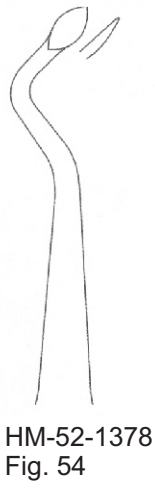




- EN —●— Root Elevators
- DE —●— Wurzelauflzüge
- ES —●— Elevadores De Raíz
- FR —●— Élévateurs De Racines
- IT —●— Elevatori Di Root



VIGNAL



BARRY
21.5 cm/8 3/4"

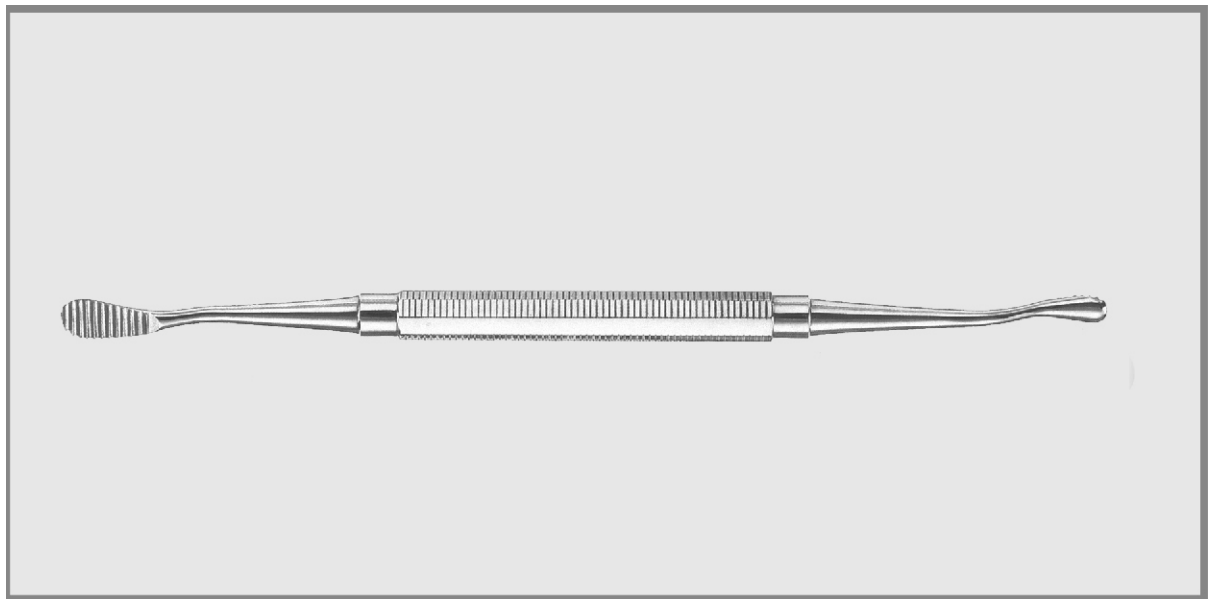


MOMAD DENTAL SUPPLIES

53

EN	Bone Files
DE	Bone-Dateien
ES	Archivos de huesos
FR	Fichiers d'os
IT	Bone Files

Page 55 to 56





- EN — Bone files
- DE — Knochenfeilen
- ES — Limes à os
- FR — Lima para huesos
- IT — Lima per ossa



downwards cutting

MILLER-COLBURN
18 cm/7"

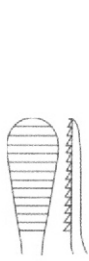
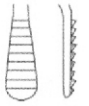


Fig. 1



HM-53-1401

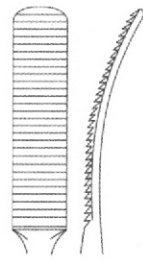
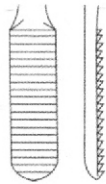


Fig. 2



HM-53-1402

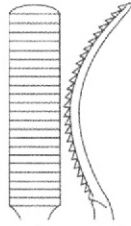
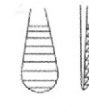


Fig. 3



HM-53-1403

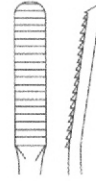
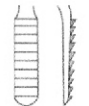


Fig. 4



HM-53-1404

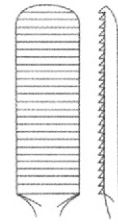
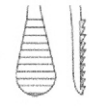


Fig. 5



HM-53-1405

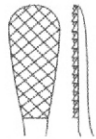
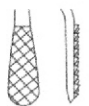


Fig. 1



HM-53-1406

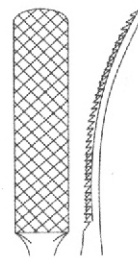
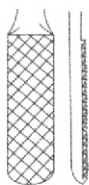


Fig. 2



HM-53-1407

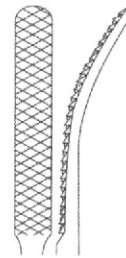
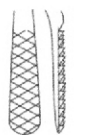


Fig. 3



HM-53-1408



Fig. 4

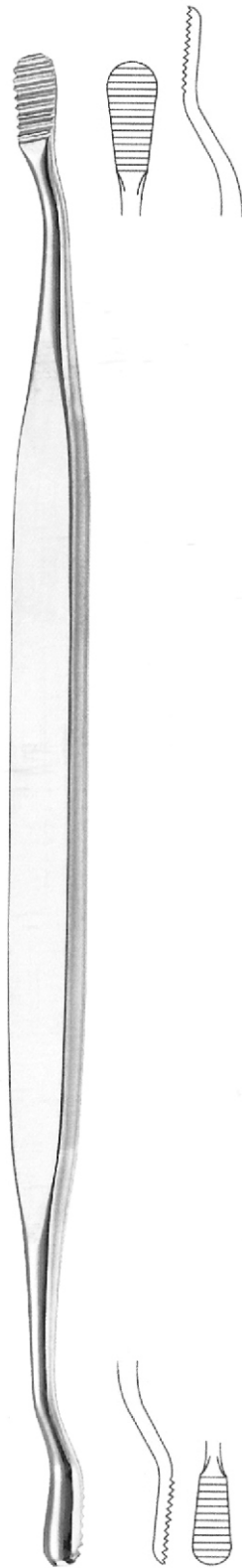


HM-53-1409

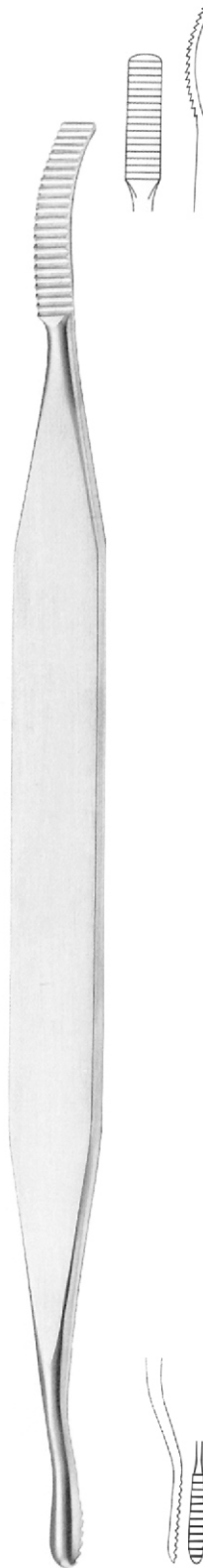
cross cut



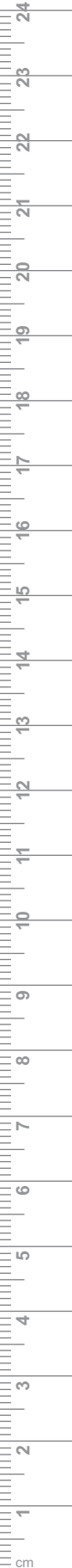
MILLER-COLBURN
18 cm/7"



SELDIN
 HM-53-1410
 18 cm/7"
 Fig. 11



SELDIN
 HM-53-1411
 18 cm/7"
 Fig. 12



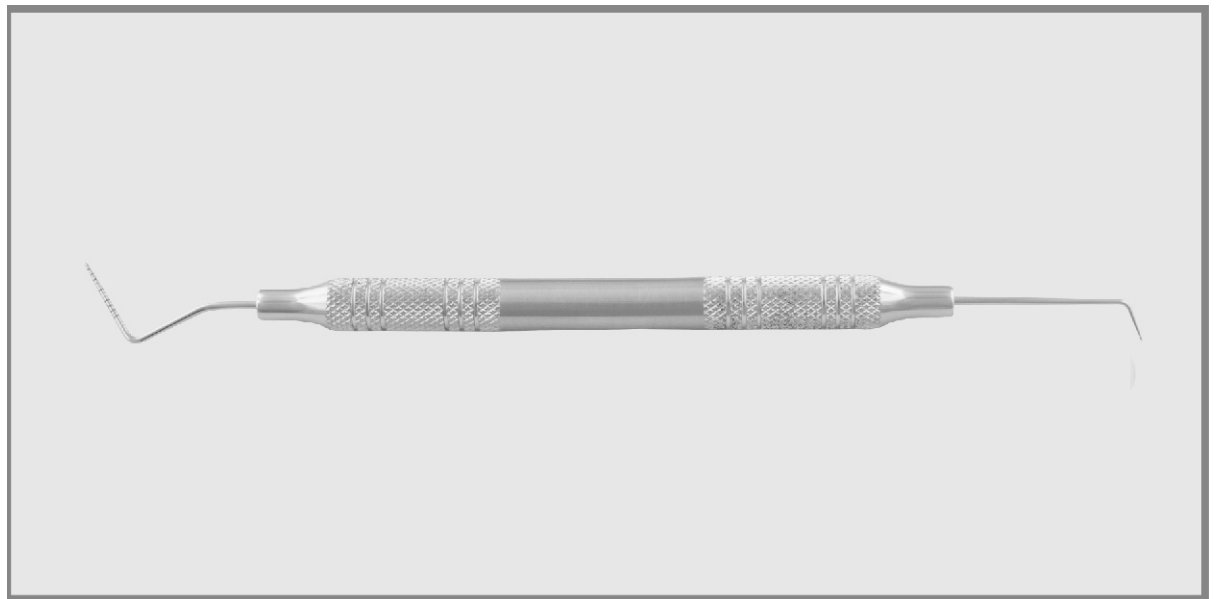


MOMAD DENTAL SUPPLIES

54

- EN** Dental Probes
- DE** Zahnsonden
- ES** Sondas dentales
- FR** Sondes dentaires
- IT** Sonde dentali

Page 57 to 58





- EN —●— Probes - Single Ended
- DE —●— Sonden - Single Ended
- ES —●— Sondas - terminación simple
- FR —●— Sondes - Single Ended
- IT —●— Sonde - Single Ended



	<p>3-6-8-11</p> <p>Fig. 8 HM-54-1451</p>	<p>1-2-3-5-7-8-9-10</p> <p>Fig. 10 HM-54-1452</p>	<p>3-6-8-11</p> <p>Fig. 11 HM-54-1453</p>	<p>1-2-3-5-7-8-9-10</p> <p>Fig. W HM-54-1454 Williams</p>	<p>3-6-9-12</p> <p>Mercury HM-54-1455</p>
	<p>1-2-3-5-7-8-9-10</p> <p>Merrit A HM-54-1456</p>	<p>1-2-3-5-7-8-9-10</p> <p>Merrit E HM-54-1457</p>	<p>1-2-3-5-7-8-9-10</p> <p>Goldman-Fox HM-54-1458</p>	<p>3-6-8</p> <p>Michigan HM-54-1459</p>	<p>3-6-9-12 with ball</p> <p>Fig. CPNG 12S HM-54-1460</p>
	<p>3.5-5.5-8.5-11.5 with ball</p> <p>Fig. CPG 11.5 WHO HM-54-1461</p>	<p>3-6-9-12</p> <p>Fig. CPG 12 HM-54-1462</p>	<p>1-2-3-4-5-6-7-8-9-10-11-12-13-14-15</p> <p>Fig. CP 15 UNC HM-54-1463</p>	<p>2-4-6-8-10-12</p> <p>Fig. CPNG 22 HM-54-1464</p>	<p>1-2-3-5-7-8-9-10</p> <p>Fig. 26G HM-54-1465</p>



1-2-3-5-7-8-9-10
FLAT



Goldman-Fox
Williams
HM-54-1466

10-9-8-7-5-3-2-1

3-6-9-12

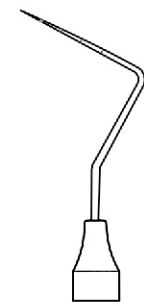


Fig. UT 3/4
Cattoni
HM-54-1467



12-9-6-3

1-2-3-5-7-8-9-10
FLAT

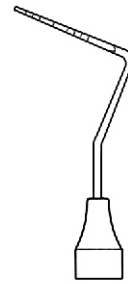
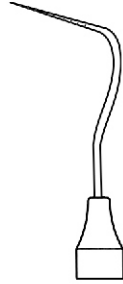


Fig. 3N
Nabers
HM-54-1468



10-9-8-7-5-3-2-1

1-2-3-5-7-8-9-10



Williams DE
Offset
HM-54-1469



10-9-8-7-5-3-2-1

3-6-9-12

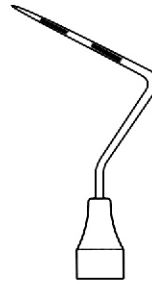


Fig. CP 12/Thin
Williams
HM-54-1470



10-9-8-7-5-3-2-1



Nabers Furcation
probes graduated
working end
HM-54-1471



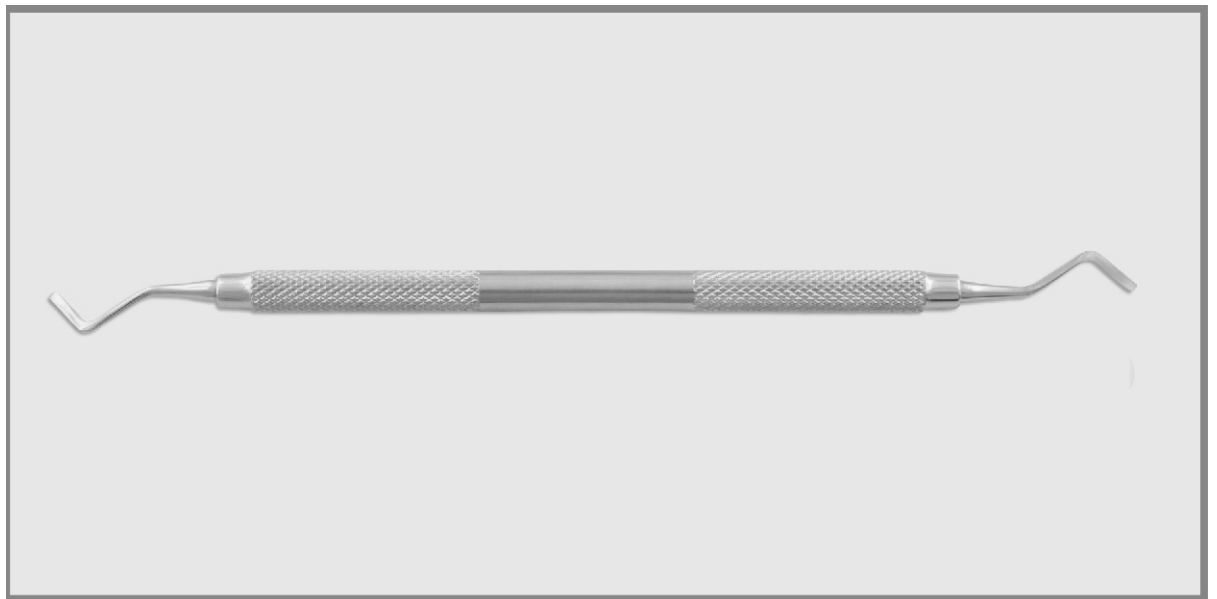


MOMAD DENTAL SUPPLIES

55

- EN** Enamel Instruments
- DE** Emaille-Instrumente
- ES** Instrumentos de esmalte
- FR** Instruments d'email
- IT** Strumenti per smalto

Page 59 to 62





MOMAD DENTAL SUPPLIES

- EN —●— Chisels
- DE —●— Meißel
- ES —●— Cinceles
- FR —●— Ciseaux
- IT —●— scalpelli



HM-55-1501
Fig. 1
Black

HM-55-1502
Fig. 2
Black

HM-55-1503
Fig. 26
Black

HM-55-1504
Fig. 27
Black

HM-55-1505
Fig. 28
Black

HM-55-1506
Fig. 29
Black





HM-55-1507
 Fig. 51/52
 Black



HM-55-1508
 Fig. 53/54
 Black



HM-55-1509
 Fig. 63/64
 Black



HM-55-1510
 Fig. 65/66
 Black



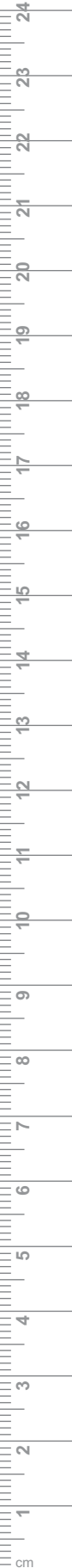
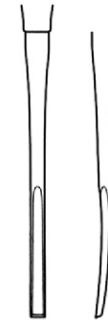
HM-55-1511
 Fig. 1/2
 Wedelstaedt



HM-55-1512
 Fig. 3/4
 Wedelstaedt



HM-55-1513
 Fig. 5/6
 Wedelstaedt





- EN Hatchets
- DE Beile
- ES Hatchets
- FR Hachettes
- IT Hatchets



HM-55-1514
Fig. 8/9H



HM-55-1515
Fig. 13/14



HM-55-1516
Fig. 15/16



HM-55-1517
Fig. 17/18



HM-55-1518
Fig. 51/52

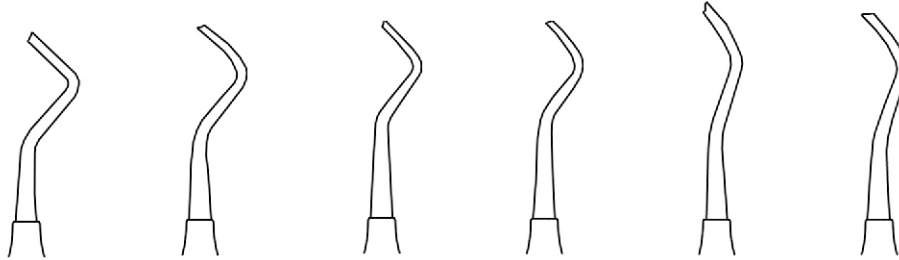


HM-55-1519
Fig. 53/54



HM-55-1520
Fig. 14/14
Off Angle





HM-55-1521
 Fig. 26
 Dista

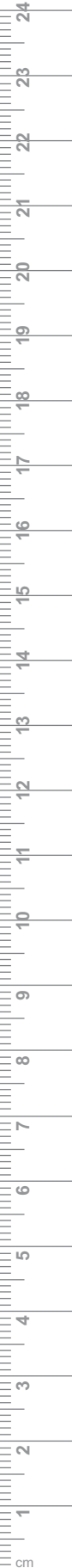
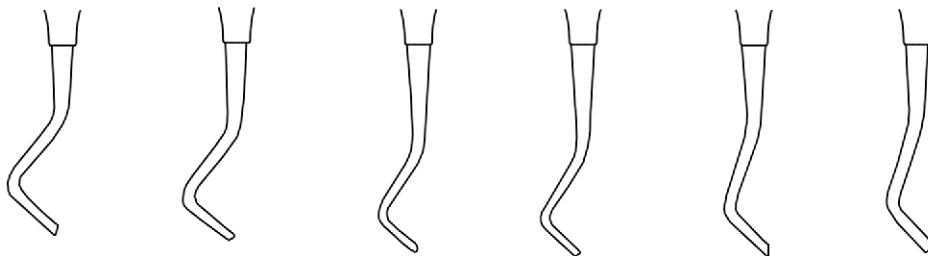
HM-55-1522
 Fig. 27
 Mesial

HM-55-1523
 Fig. 28
 Distal

HM-55-1524
 Fig. 29
 Mesial

HM-55-1525
 Fig. 77/78
 Distal

HM-55-1526
 Mesial
 54-1142-00



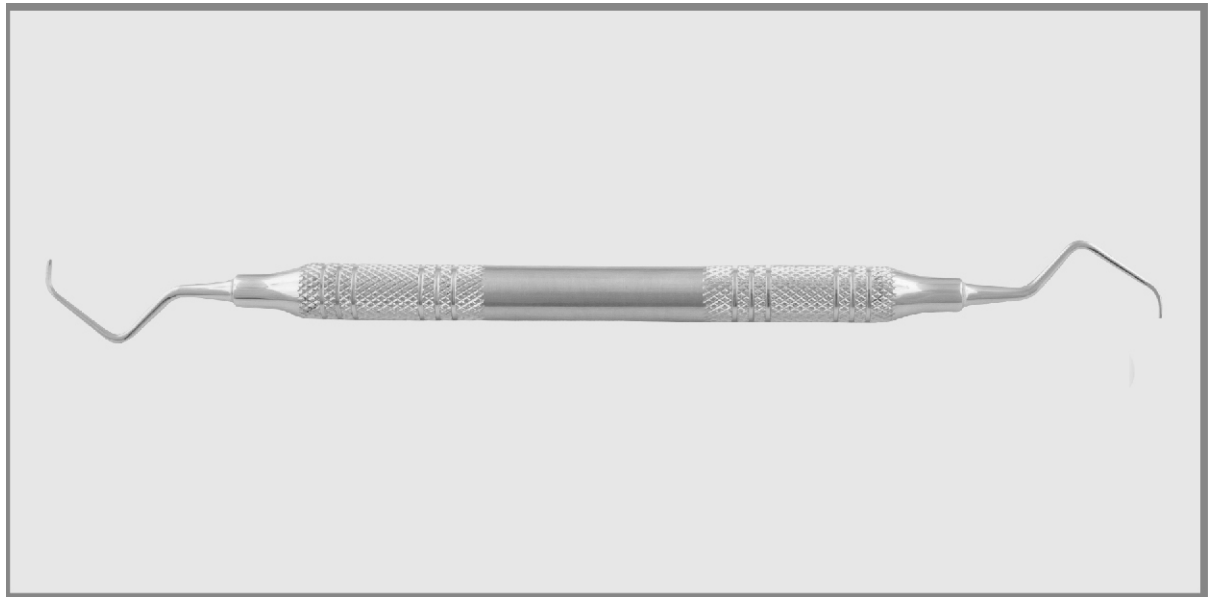


MOMAD DENTAL SUPPLIES

56

- EN** Dental Scalers
- DE** Zahnsteinentferner
- ES** Escaladores dentales
- FR** Scalers dentaires
- IT** Scaler dentali

Page 63 to 78





- EN —● Explorers - Single Ended
- DE —● Forscher - Single Ended
- ES —● Explorers - Single Finded
- FR —● Explorateurs - Single Ended
- IT —● Esploratori - Single Ended



Fig. 3
700-140

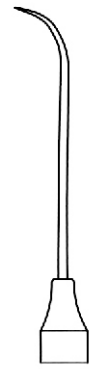


Fig. 3A
HM-56-1551



Fig. 5
HM-56-1552



Fig. 6
HM-56-1553
6.5 mm

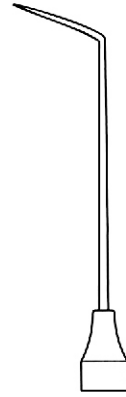


Fig. 6A
HM-56-1554
12 mm

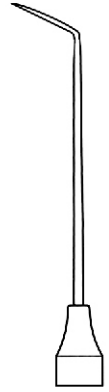


Fig. 6L
HM-56-1555
9 mm

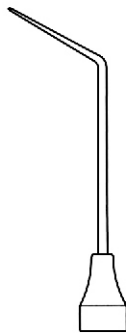


Fig. 6XL
HM-56-1556
12.5 mm

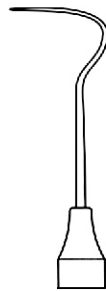


Fig. 8
HM-56-1557



Fig. 8A
HM-56-1558

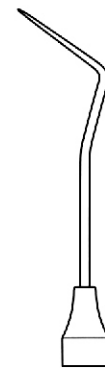


Fig. 9
HM-56-1559

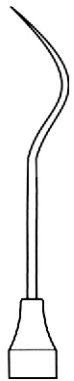


Fig. 10
HM-56-1560



Fig. 12
HM-56-1561



Fig. 17
HM-56-1562



Fig. 17A
HM-56-1563



Fig. 23
HM-56-1564
Shepherd's Hook

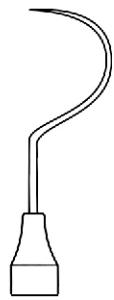


Fig. 54
HM-56-1565



Fig. UT 1/2
HM-56-1566

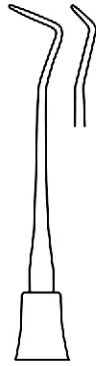


Fig. UT 2/2
HM-56-1567



Fig. 3CH/3CH
HM-56-1568



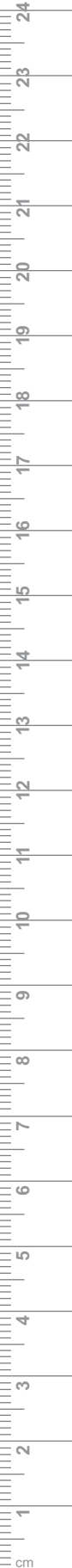
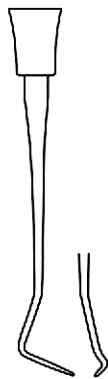
Fig. 6/3
HM-56-1569



Fig. 16/3
HM-56-1570



Fig. 2
HM-56-1571





- EN —● Explorers - Double Ended
- DE —● Forscher - Doppelt beendigt
- ES —● Exploradores - Doble final
- FR —● Explorers - Double Ended
- IT —● Esploratori - Double Ended



Fig. 23/17
HM-56-1572



Fig. 2A
HM-56-1573



Fig. 3
HM-56-1574



Fig. 1N
HM-56-1575
Nabers

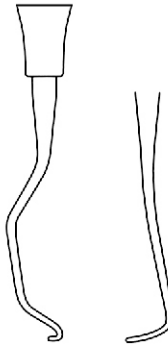


Fig. 2N
HM-56-1576
Nabers

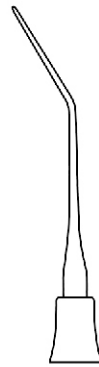
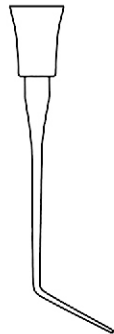


Fig. 5/6
HM-56-1577



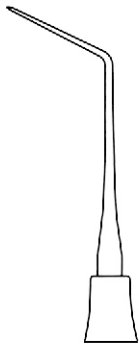


Fig. 16/23
HM-56-1578



Fig. 6/23
HM-56-1579



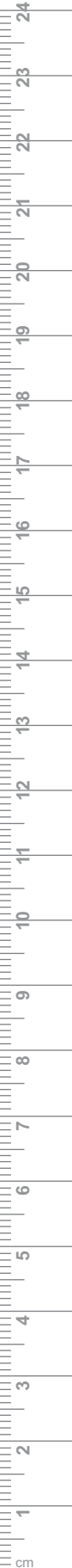
Fig. 6/17
HM-56-1580



Fig. 23/17A
HM-56-1581



Fig. 3/23
HM-56-1582





- EN —●— Gracey Curettes
- DE —●— Gracey Küretten
- ES —●— Gracey Curettes
- FR —●— Curettes Gracey
- IT —●— Gracey Curettes



HM-56-1583
Fig. 1/2



HM-56-1584
Fig. 3/4



HM-56-1585
Fig. 5/6



HM-56-1586
Fig. 7/8





HM-56-1587
Fig. 9/10



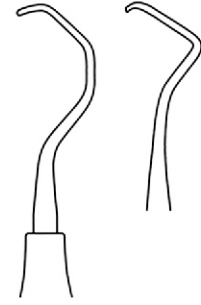
HM-56-1588
Fig. 11/12



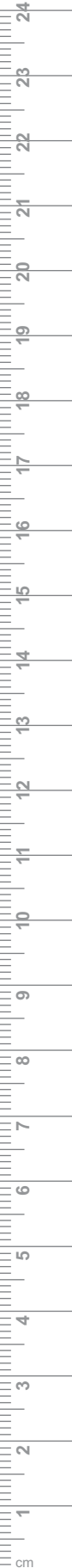
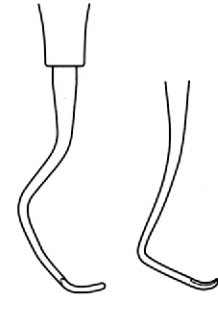
HM-56-1589
Fig. 13/14



HM-56-1590
Fig. 15/16



HM-56-1591
Fig. 17/18

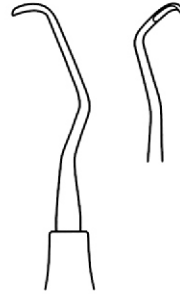




- EN —●— Universal Curettes
- DE —●— Universalküretten
- ES —●— Curetas universales
- FR —●— Curettes universelles
- IT —●— Curette universali



Langer
HM-56-1592
Fig. 1/2



Langer
HM-56-1593
Fig. 3/4



Langer
HM-56-1594
Fig. 5/6

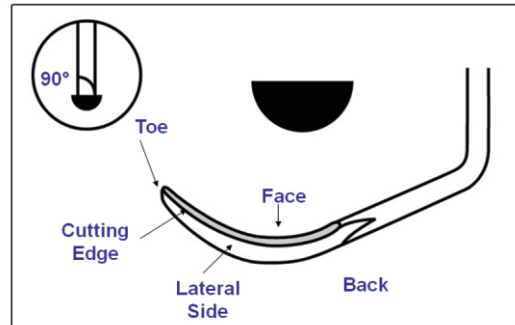


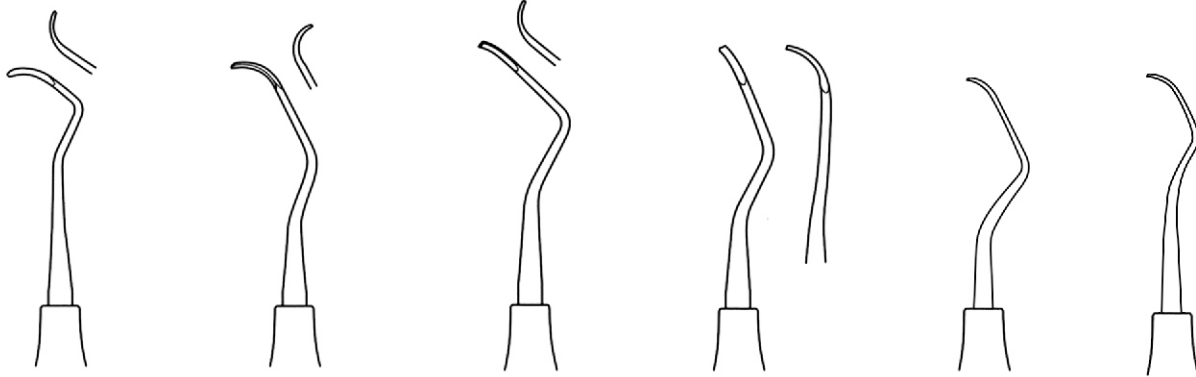
Langer
HM-56-1595
Fig. 17/18



Universal curettes are designed for easy adaptation on all tooth surfaces (thus the name "universal").

The blade of a universal curette has a round toe and back, and two cutting edges for scaling, making it an efficient design for scaling the entire mouth.





Columbia
 HM-56-1596
 Fig. 13/14

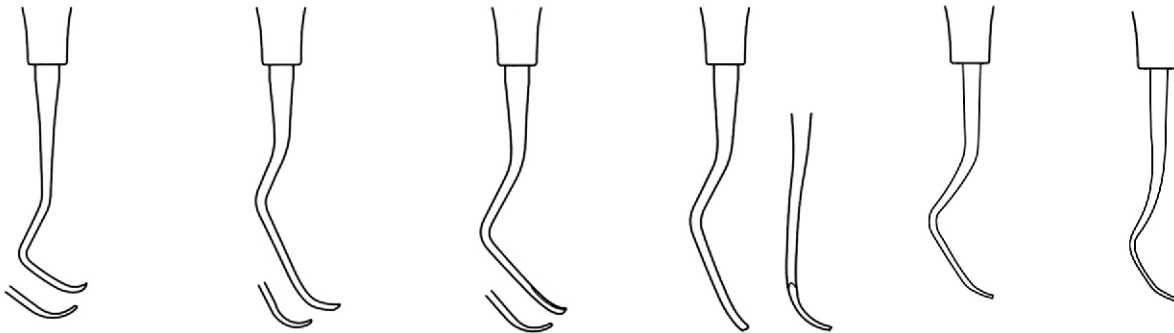
Columbia
 HM-56-1597
 Fig. 2R/2L

Columbia
 HM-56-1598
 Fig. 4R/4L

HM-56-1599
 Fig. Gx4

Barnhart
 HM-56-1600
 Fig. 1/2

Barnhart
 HM-56-1601
 Fig. 5/6





- EN —●— Universal Curettes
- DE —●— Universalküretten
- ES —●— Curetas universales
- FR —●— Curettes universelles
- IT —●— Curette universali



HM-56-1602
Fig. Me1



HM-56-1603
Rule [23-24]
Fig. 3/4



HM-56-1604
Fig. IU 13/14
Indiana University



HM-56-1605
Fig. IU 17/18
Indiana University



HM-56-1606
Fig. 7/8
Younger-Good



HM-56-1607
Fig. 1/2
Bunting



HM-56-1608
Fig. 5/6
Bunting





HM-56-1609
 Fig. 1
 Furcation curette



HM-56-1610
 Fig. 2
 Furcation curette



HM-56-1611
 Fig. 3
 Furcation curette



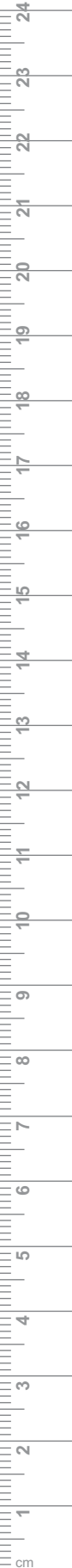
HM-56-1612
 Fig. 4
 Furcation curette



HM-56-1613
 Fig. 5
 Furcation curette



HM-56-1614
 Fig. 1/2
 Prichard





- EN —●— Scalars / Curettes
- DE —●— Scaler / Küretten
- ES —●— Scalars / Curettes
- FR —●— Scalars / Curettes
- IT —●— Scaler / Curette



HM-56-1615
Goldman-Fox
Fig. 1



HM-56-1616
Goldman-Fox
Fig. 2



HM-56-1617
Goldman-Fox
Fig. 3



HM-56-1618
Goldman-Fox
Fig. 4



HM-56-1619
Goldman-Fox
Fig. 5

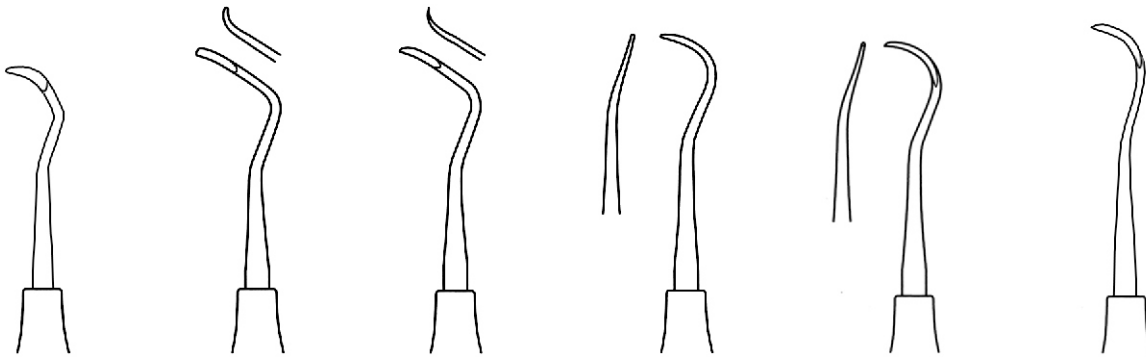


HM-56-1620
Goldman-Fox
Fig. 6



HM-56-1621
Goldman-Fox
Fig. 21





HM-56-1622
 McCall
 Fig. 11/12

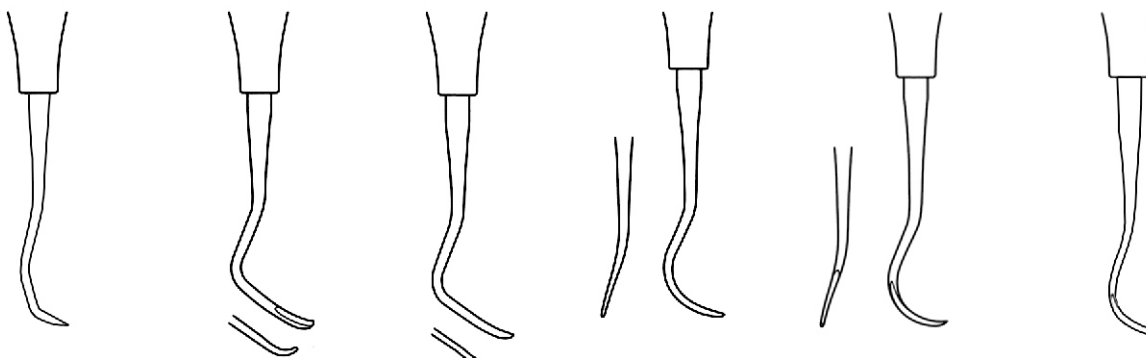
HM-56-1623
 McCall
 Fig. 13S/14S

HM-56-1624
 McCall
 Fig. 13SM/14

HM-56-1625
 McCall
 Fig. 17/18

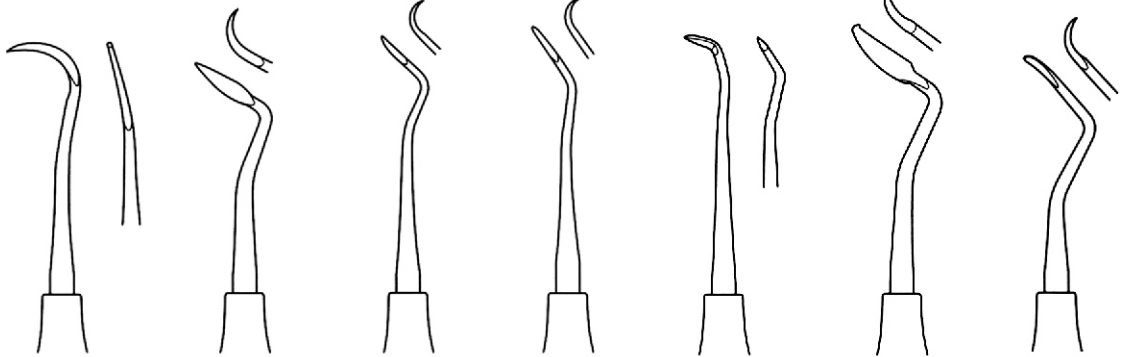
HM-56-1626
 McCall
 Fig. 17S/18S

HM-56-1627
 McCall
 Fig. 19/20





- EN —●— Sickle Scaler
- DE —●— Sichel-Scaler
- ES —●— Escalador de hoz
- FR —●— Scaler de faucille
- IT —●— Sickle Scaler



HM-56-1628
Hygienist
Fig. H6/H7

HM-56-1629
Fig. 204

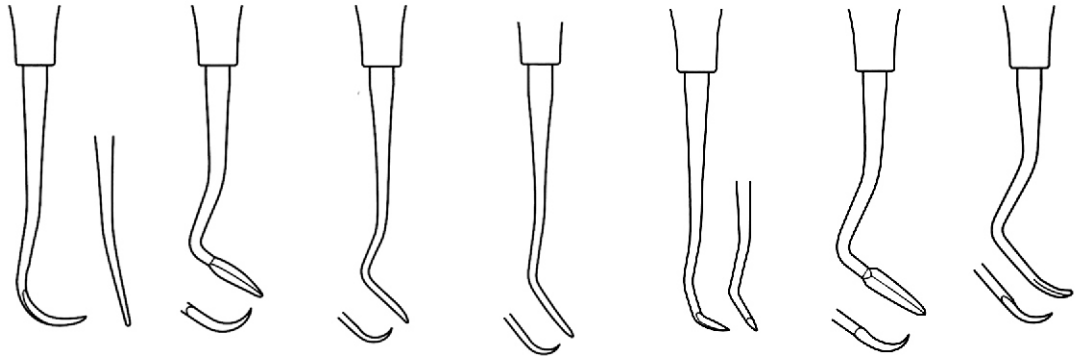
HM-56-1630
Fig. 204 S

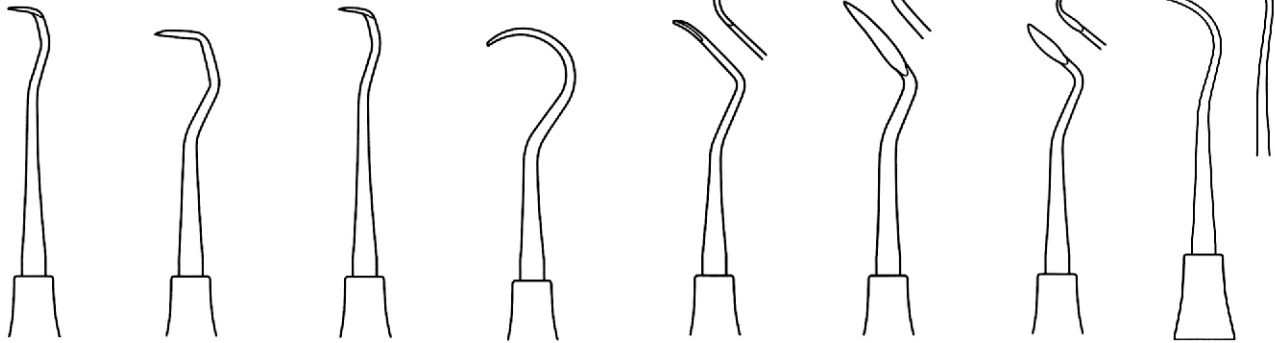
HM-56-1631
Fig. 204 SD

HM-56-1632
Zürich

HM-56-1633
Fig. CC 6

HM-56-1634
Fig. M 23





HM-56-1635
 Hygienist-Towner
 Fig. H5/33

HM-56-1636
 Towner
 Fig. U15/30

HM-56-1637
 Towner
 Fig. U15/33

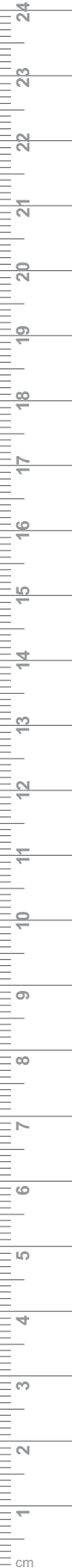
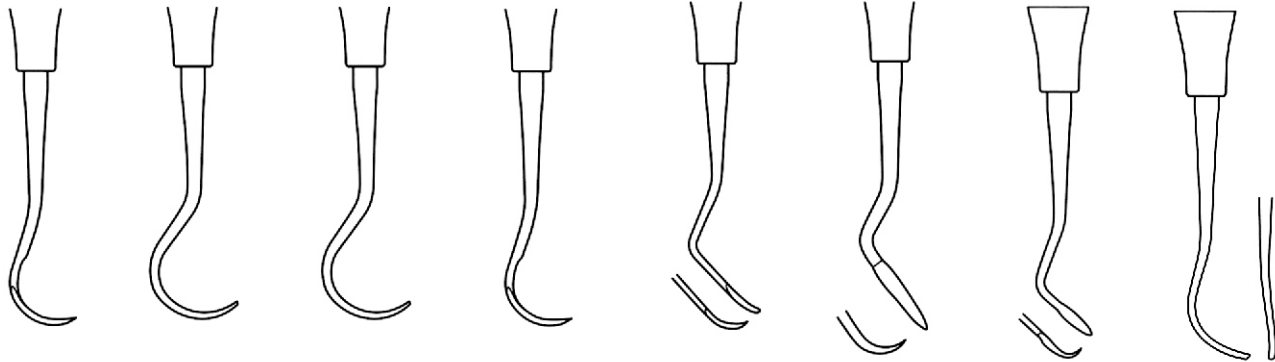
HM-56-1638
 Hygienist-Towner
 Fig. H5/U15

HM-56-1639
 Fig. U 135

HM-56-1640
 Fig. CI 2/3

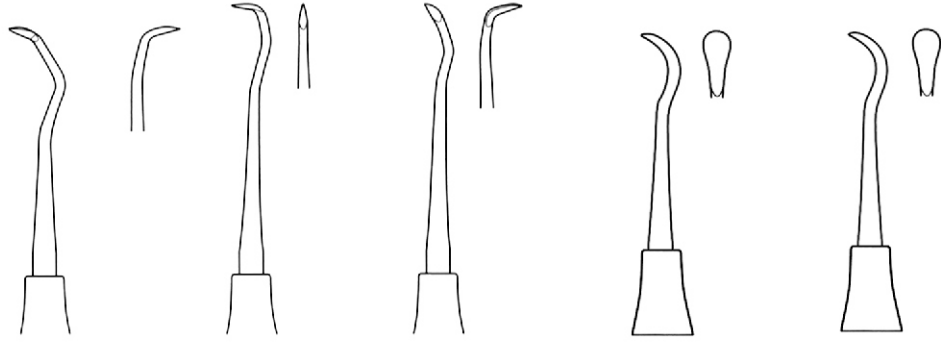
HM-56-1641
 Taylor
 Fig. T2/T3

HM-56-1642
 Younger-Good
 Fig. 33/34





- EN —●— Sickle Scaler
- DE —●— Sichel-Scaler
- ES —●— Escalador de hoz
- FR —●— Scaler de faucille
- IT —●— Sickle Scaler



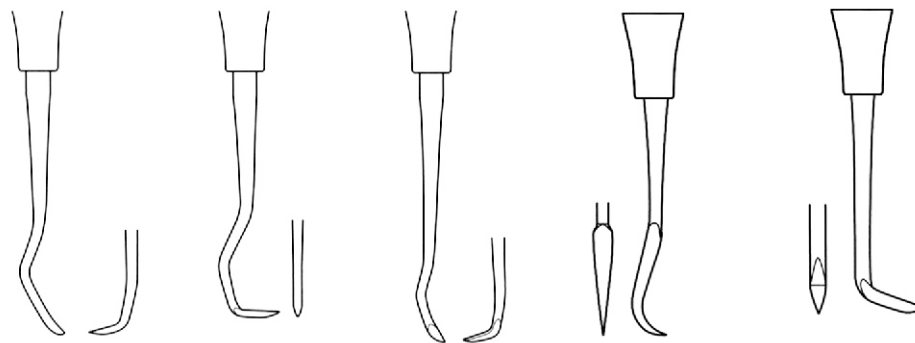
HM-56-1643
Jacquette
Fig. 31/32

HM-56-1644
Jacquette
Fig. 30/33

HM-56-1645
Jacquette
Fig. 34/35

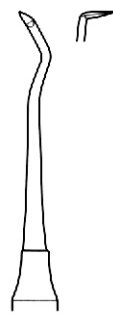
HM-56-1646
Cumine
Fig. 33

HM-56-1647
Mitchell
Fig. 34

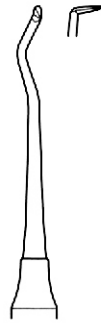




HM-56-1648
 Jacquette
 Fig. 33



HM-56-1649
 Jacquette
 Fig. 34



HM-56-1650
 Jacquette
 Fig. 35



HM-56-1651
 Ward-Kirkland
 Fig. 1



HM-56-1652
 Crane-Kaplan
 Fig. 2



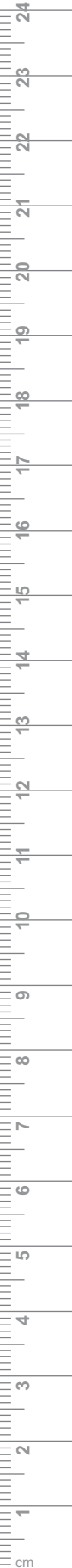
HM-56-1653
 Mercitan
 Fig. Sh5



HM-56-1654
 Crane-Kaplan
 Fig. 3



HM-56-1655
 White
 Fig. 12B



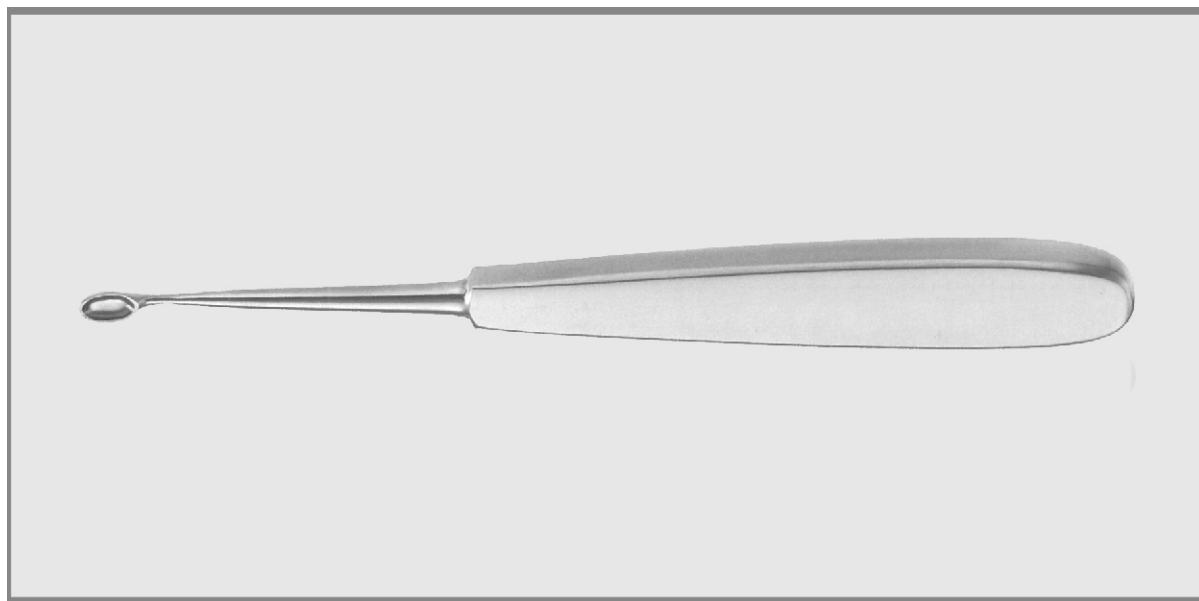


MOMAD DENTAL SUPPLIES

57

- EN** Bone Curettes
- DE** Knochenküretten
- ES** Curetas de hueso
- FR** Curettes osseuses
- IT** Curette d'ossa

Page 79 to 84





- EN —●— Bone Curettes
- DE —●— Scharf Löffel
- ES —●— Curettes à os
- FR —●— Cucharillas cortantes
- IT —●— Curette taglienti

HM-57-1701
HM-57-1702

HM-57-1703
HM-57-1704



WILLIGER

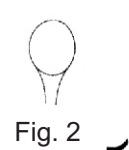
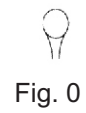


Fig. 00
Fig. 0
Fig. 1
Fig. 2

HM-57-1705	HM-57-1709
HM-57-1706	HM-57-1710
HM-57-1707	HM-57-1711
HM-57-1708	HM-57-1712

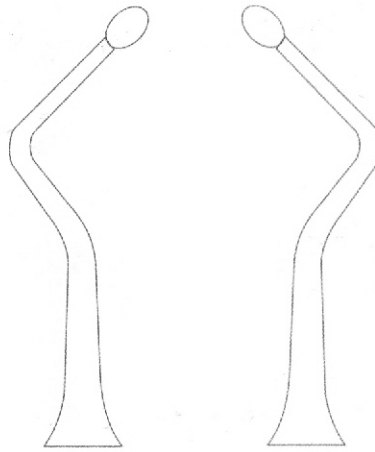
HM-57-1713	HM-57-1717
HM-57-1714	HM-57-1718
HM-57-1715	HM-57-1719
HM-57-1716	HM-57-1720



Mod. USA

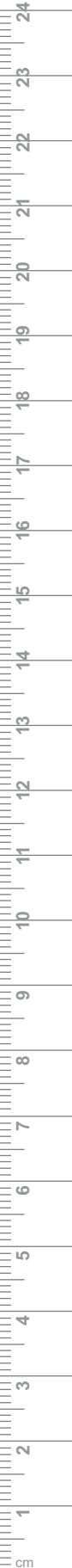


Fig. 1	HM-57-1721		
Fig. 2	HM-57-1722		
Fig. 3	HM-57-1723		
Fig. 4	HM-57-1724		
Fig. 5	HM-57-1725		
Fig. 6	HM-57-1726		
		R	L
		HM-57-1727	HM-57-1733
		HM-57-1728	HM-57-1734
		HM-57-1729	HM-57-1735
		HM-57-1730	HM-57-1736
		HM-57-1731	HM-57-1737
		HM-57-1732	HM-57-1738



CHOMPRET
 HM-57-1739

HM-57-1740 R
 HM-57-1741 L





- EN ● Bone Curettes
- DE ● Scharf Löffel
- ES ● Curettes à os
- FR ● Cucharillas cortantes
- IT ● Curette taglienti

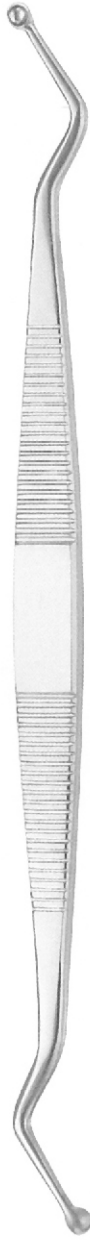


WILLGER

HM-57-1742
Fig. 00/00

HM-57-1743
Fig. 0/0

HM-57-1744
Fig. 1/1



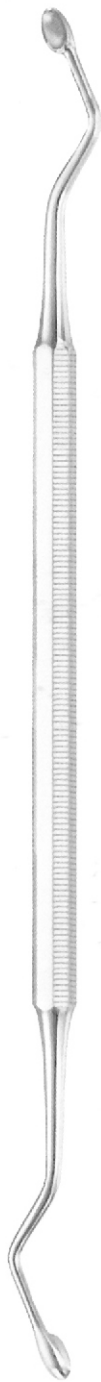
MARTINI

HM-57-1745
Fig. 00/00

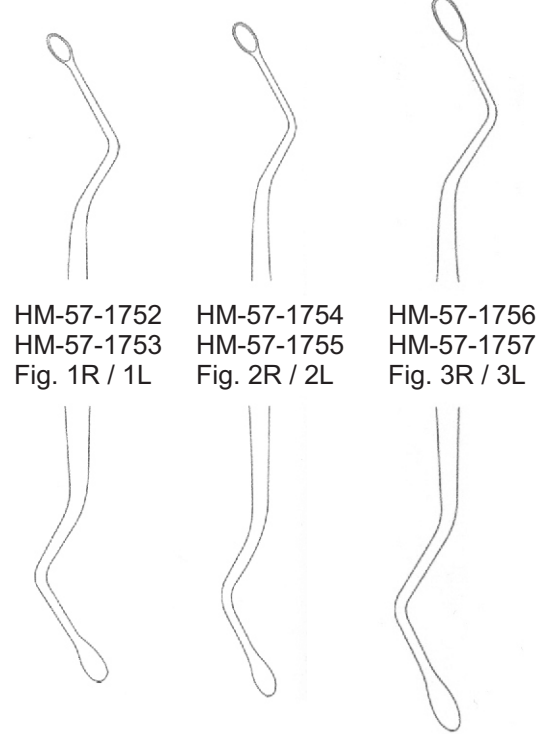
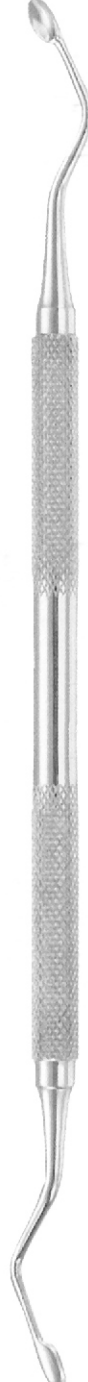
HM-57-1746
Fig. 0/0

HM-57-1747
Fig. 1/1

HM-57-1748- HM-57-1750R-
HM-57-1749 HM-57-1751R



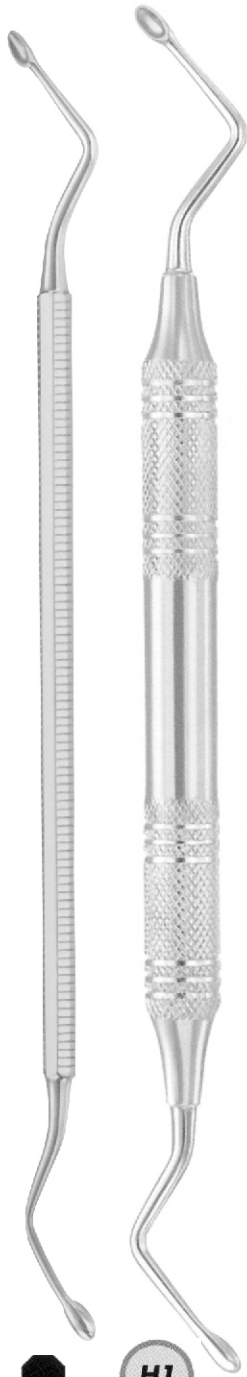
HEMINGWAY
18 CM/7"



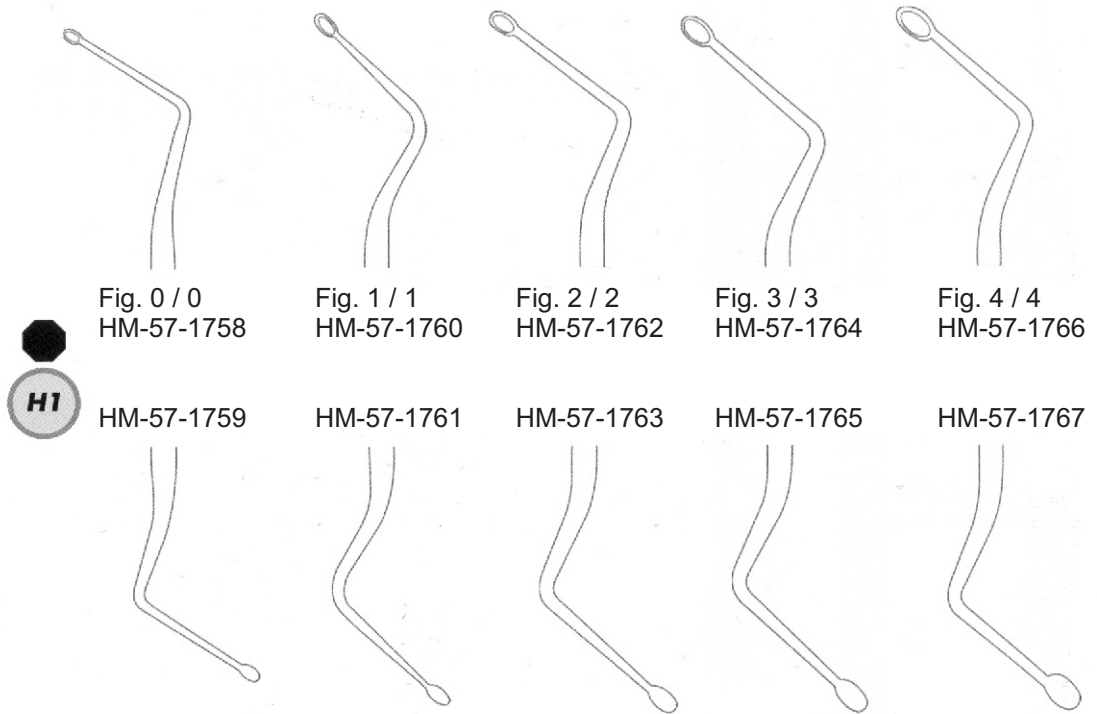
HM-57-1752
HM-57-1753
Fig. 1R / 1L



HM-57-1754
HM-57-1755
Fig. 2R / 2L

HM-57-1756
HM-57-1757
Fig. 3R / 3L



5,5 mm Ø9,5 mm
 HEMINGWAY
 17 cm/6 3/4"



	Fig. 0 / 0 HM-57-1758	Fig. 1 / 1 HM-57-1760	Fig. 2 / 2 HM-57-1762	Fig. 3 / 3 HM-57-1764	Fig. 4 / 4 HM-57-1766
	HM-57-1759	HM-57-1761	HM-57-1763	HM-57-1765	HM-57-1767

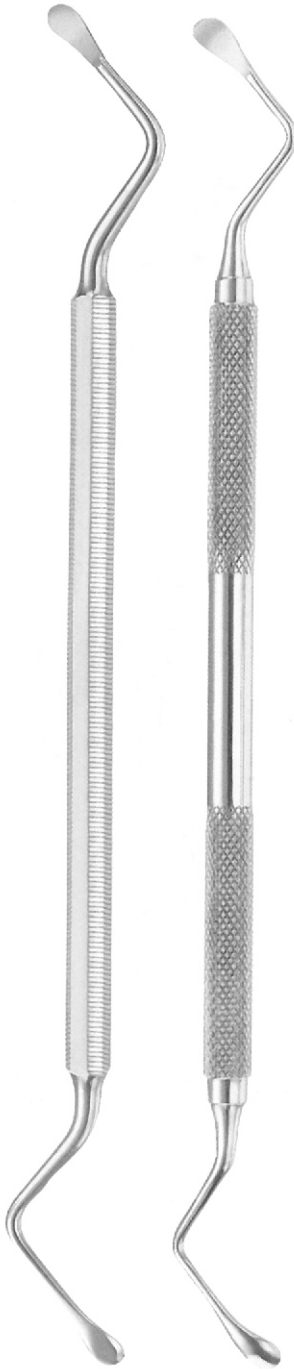




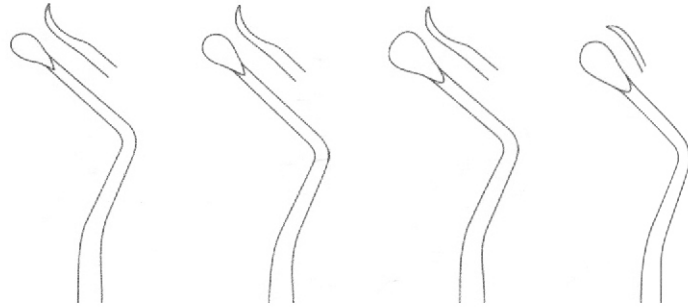
- EN ● Bone Currettes
- DE ● Scharf Löffel
- ES ● Curettes á os
- FR ● Cucharillas cortantes
- IT ● Curette taglienti

MOMAD DENTAL SUPPLIES

HM-57-1768 HM-57-1770
 HM-57-1769 HM-57-1771



LUCAS
 17 cm/6¾"



HM-57-1772 HM-57-1774 HM-57-1776 HM-57-1778
 HM-57-1773 HM-57-1775 HM-57-1777 HM-57-1779
 Fig. 1 / 1 Fig. 2 / 2 Fig. 3 / 3 Fig. 4 / 4

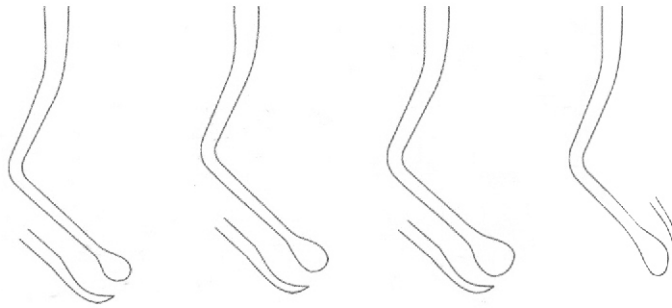




Fig. 4



Fig. 5



Fig. 1



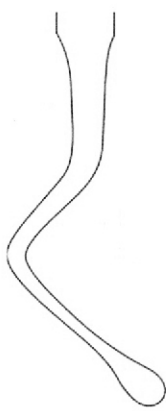
Fig. 2



Fig. 3



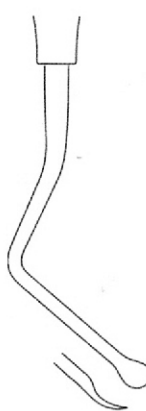
Fig. 4



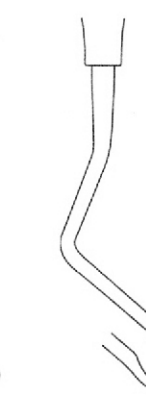
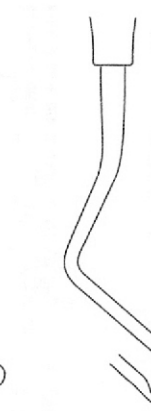
MEAD
 HM-57-1780 HM-57-1781



HM-57-1782



MILLER-COLBURN
 HM-57-1783 HM-57-1784 HM-57-1785





MOMAD DENTAL SUPPLIES

58

EN	Excavators
DE	Bagger
ES	Excavadoras
FR	Pelles
IT	escavatori

Page 85 to 89





- EN —●— Excavators
- DE —●— Exkavatoren
- ES —●— Excavateurs
- FR —●— Excavadores
- IT —●— Escavatori

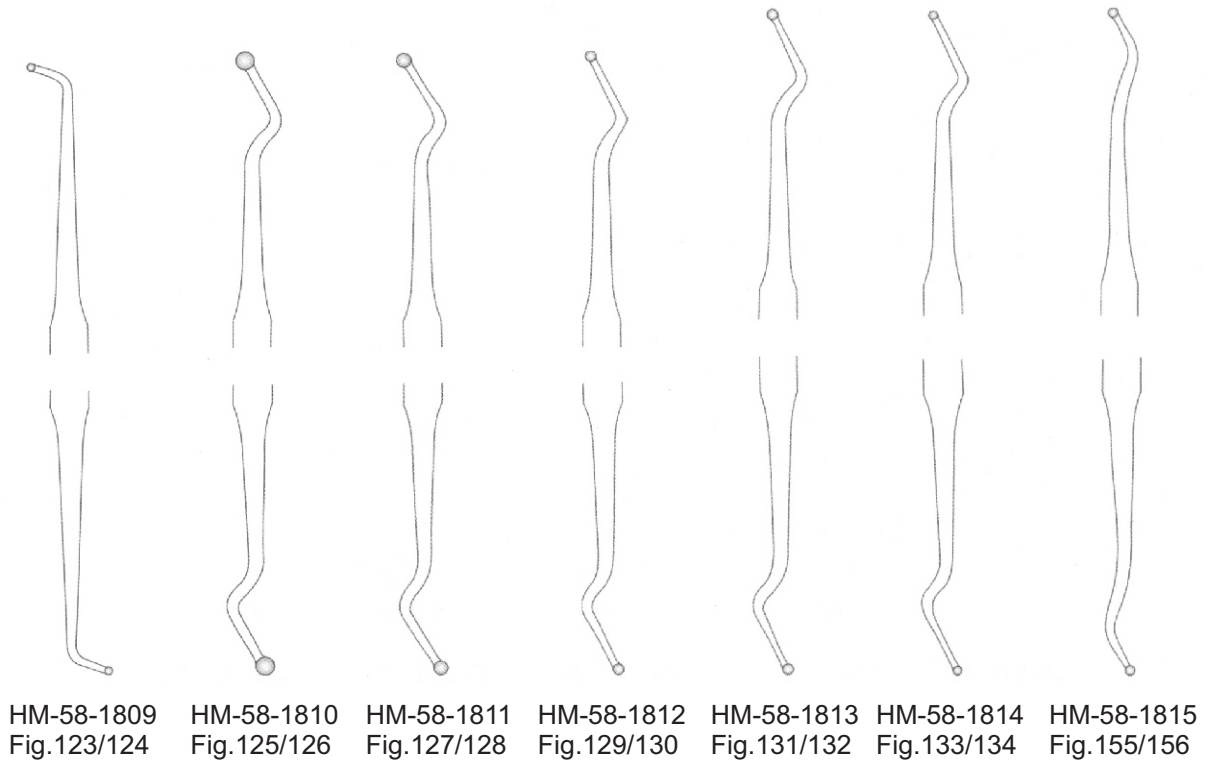
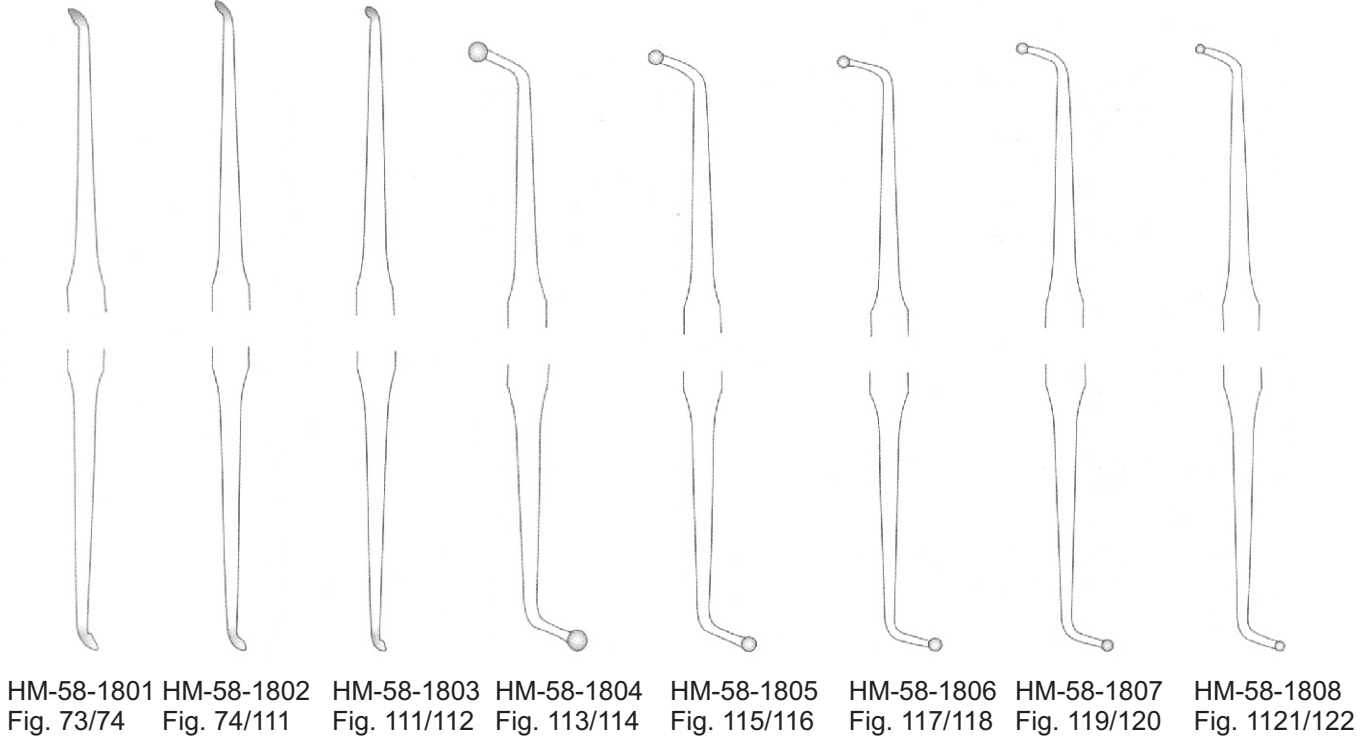
MOMAD DENTAL SUPPLIES

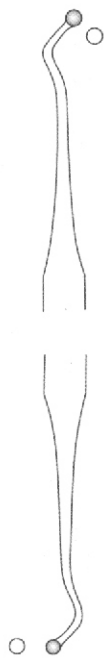


HM-58-1800
Fig.72/73

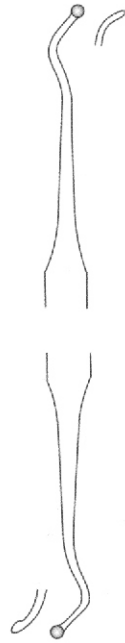


5.5 mm





HM-58-1816
 Fig.139/140



HM-58-1817
 Fig.141/142



HM-58-1818
 Fig.159/160



HM-58-1819
 Fig.161/162



HM-58-1820
 Fig.165/166



HM-58-1821
 Fig.171/172



HM-58-1822
 Fig.173/174



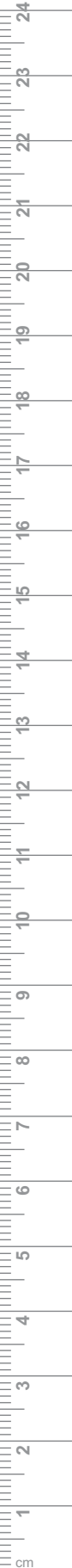
HM-58-1823
 Fig.175/176



HM-58-1824
 Fig.177/178



HM-58-1825
 Fig.179/180





HM-58-1826
Fig. 5



HM-58-1827
Fig. 13



WHITE
HM-58-1828
Fig. 14



HM-58-1829
Fig. 15



HM-58-1830
Fig. 17



HM-58-1831
Fig. 18



HM-58-1832
Fig. 19



WHITE
HM-58-1833
Fig. 20



HM-58-1834
Fig. 23



HM-58-1835
Fig. 25



Ø6
mm

H1
Ø9,5
mm

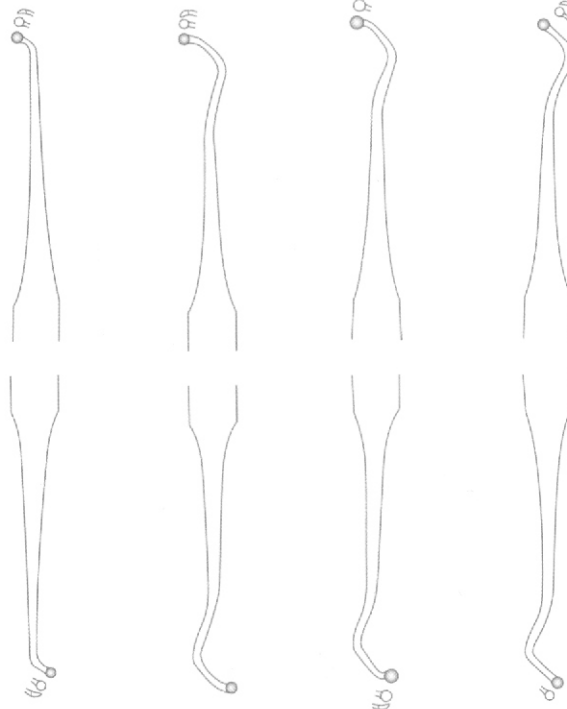


Fig. 5 HM-58-1836 Fig. 13 HM-58-1837 Fig. 14 HM-58-1838 Fig. 17 HM-58-1839

H1 HM-58-1840 HM-58-1841 HM-58-1842 HM-58-1843

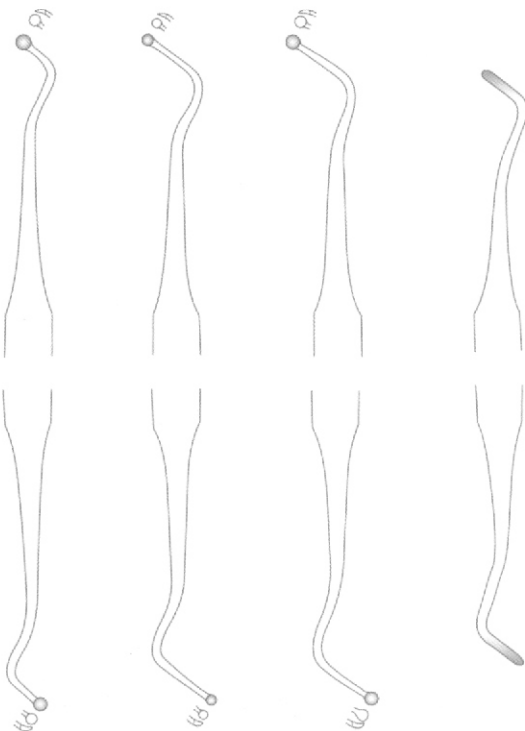
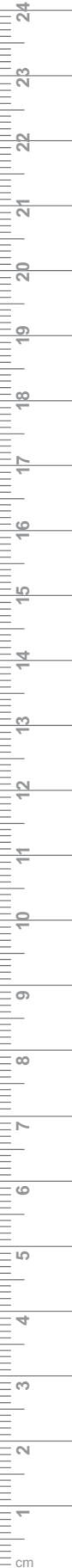


Fig.18 HM-58-1844 Fig. 31 HM-58-1845 Fig. 33 HM-58-1846 Fig. 35 HM-58-1847

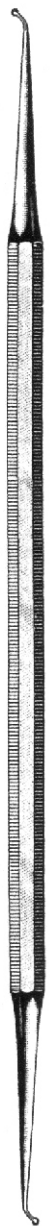
H1 HM-58-1848 HM-58-1849 HM-58-1850 HM-58-1851





- EN —●— Excavators
- DE —●— Exkavatoren
- ES —●— Excavateurs
- FR —●— Excavadores
- IT —●— Escavatori









MOMAD DENTAL SUPPLIES








HM-58-1852
Fig. 5/6



DARBY-PERRY

							
HM-58-1853 Fig. 7/8	HM-58-1854 Fig. 9/10	HM-58-1855 Fig. 11/12	HM-58-1856 Fig. 13/14	HM-58-1857 Fig. 15/16	HM-58-1858 Fig. 17/18	HM-58-1859 Fig. 19/20	HM-58-1860 Fig. 21/22

GILLET

				
HM-58-1861 Fig. 4/5	HM-58-1862 Fig. 6/7	HM-58-1863 Fig. 7/8	HM-58-1864 Fig. 12/13	HM-58-1865 Fig. 14/15

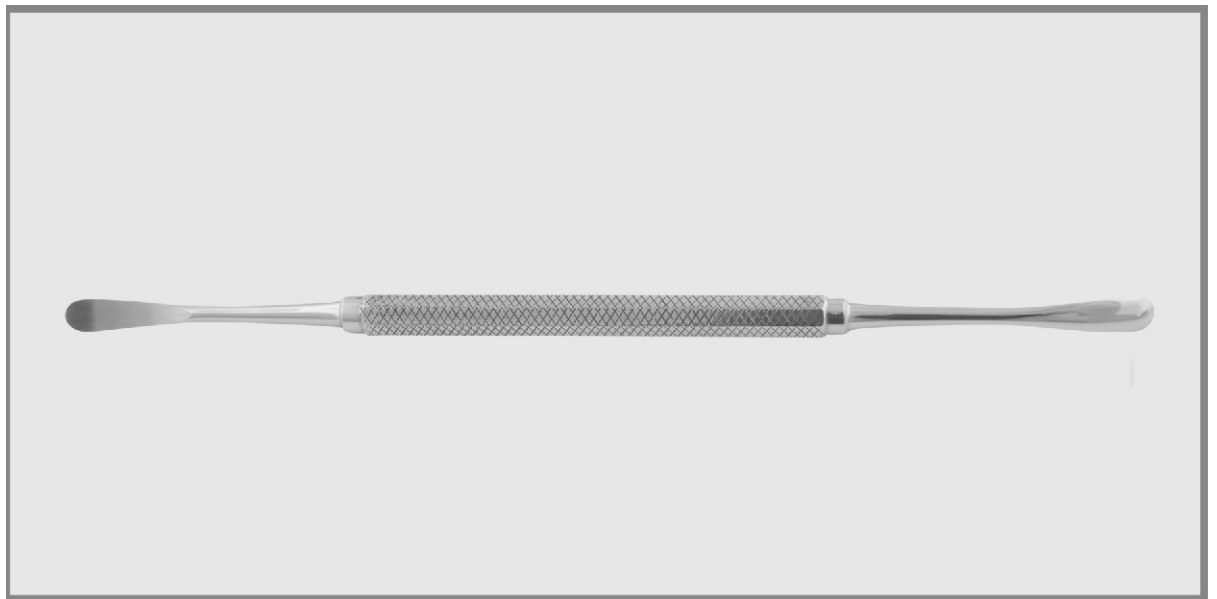


MOMAD DENTAL SUPPLIES

59

EN	Wax Proclein
DE	Wachs-Porzellan
ES	cera Porcelana
FR	Cire Porcelaine
IT	Cera porcellana

Page 90 to 94





5,5 mm



H1
 Ø9,5 mm



HM-59-1901 Fig. 1



HM-59-1902 Fig. 2



HM-59-1903 Fig. 3



HM-59-1904 Fig. 4



HM-59-1905 Fig. 5



HM-59-1906H HM-59-1907H HM-59-1908H HM-59-1909H HM-59-1910H

Aluminium

HM-59-1911

HM-59-1912

HM-59-1913

HM-59-1914

HM-59-1915

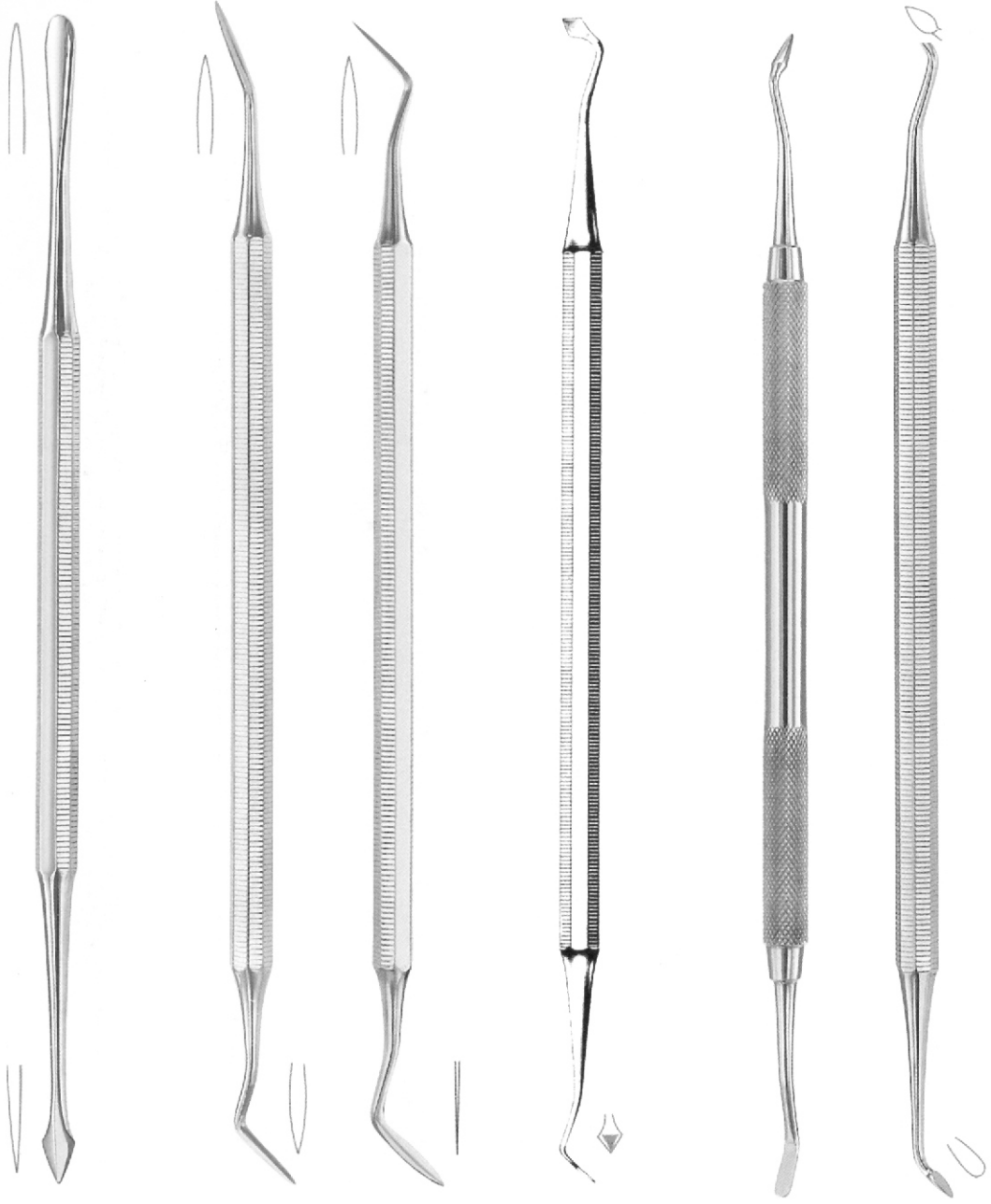
gold

green

blue

red

silver



GRITMAN
 HM-59-1916

WARD
 HM-59-1917 Fig. 1
 HM-59-1918 Fig. 2

FRAHM
 HM-59-1919

SHOSHAN
 HM-59-1920
 SHO-A

W.A.C.D
 HM-59-1921





HYLIN
HM-59-1922



ZAHLE
HM-59-1923



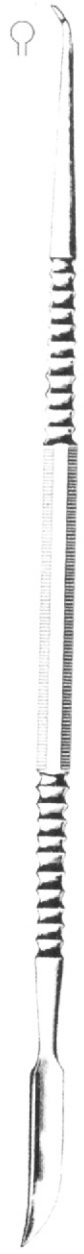
HM-59-1924



LE CRON
HM-59-1925



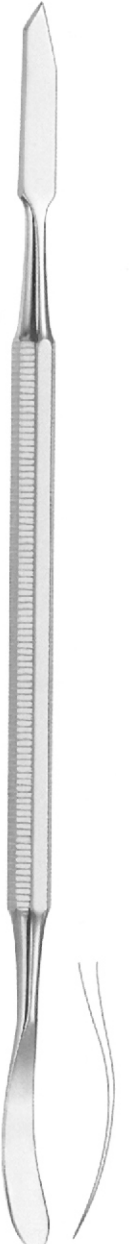
HM-59-1926



HM-59-1927



VEHE
HM-59-1928



FIELDSTAD
HM-59-1929



ROACH
 HM-59-1930 HM-59-1931

RIEGNER
 HM-59-1932

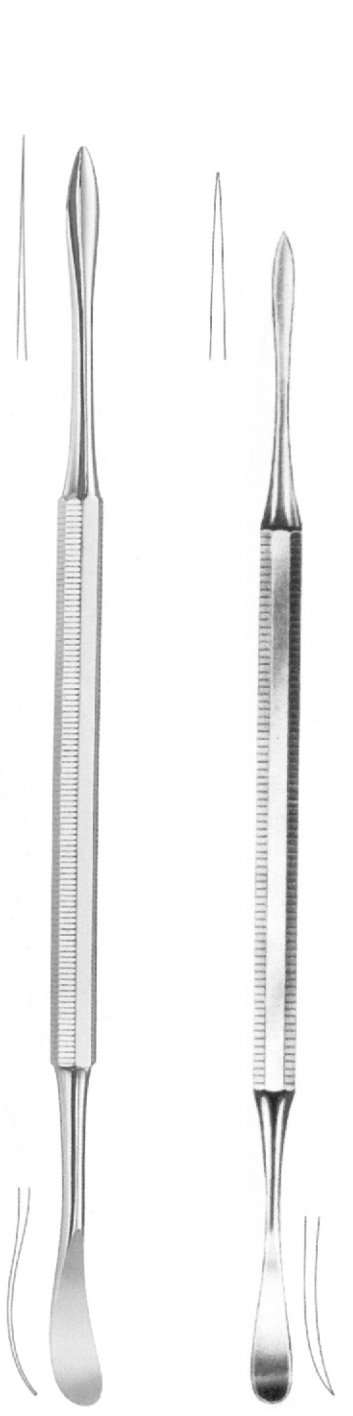
HM-59-1933
 Fig. 1

HM-59-1934
 Fig. 2

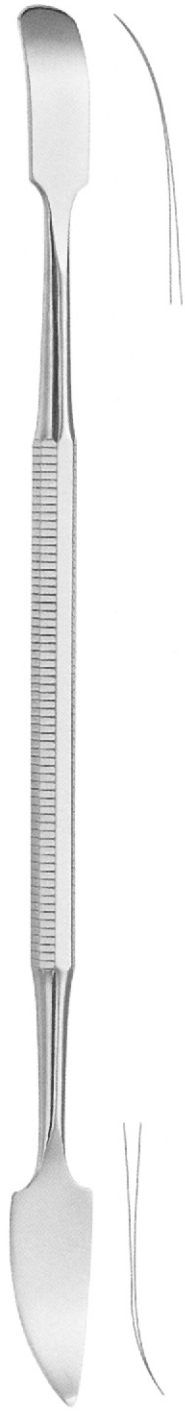
FRAHM
 HM-59-1935
 Fig. 6

HM-59-1936
 Fig. 10

HM-59-1937
 Fig. 6/10



BEALE
 HM-59-1938 HM-59-1939
 Fig. 7A



GRITMAN
 HM-59-1940
 19,5 cm/7 3/4"



WESTON
 HM-59-1941

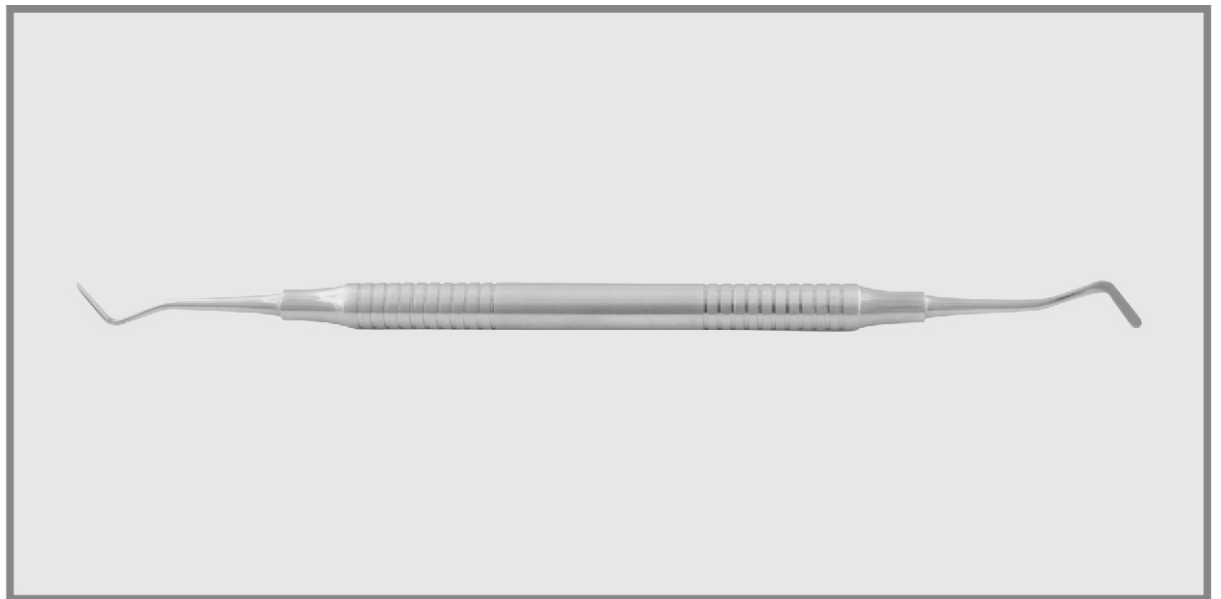


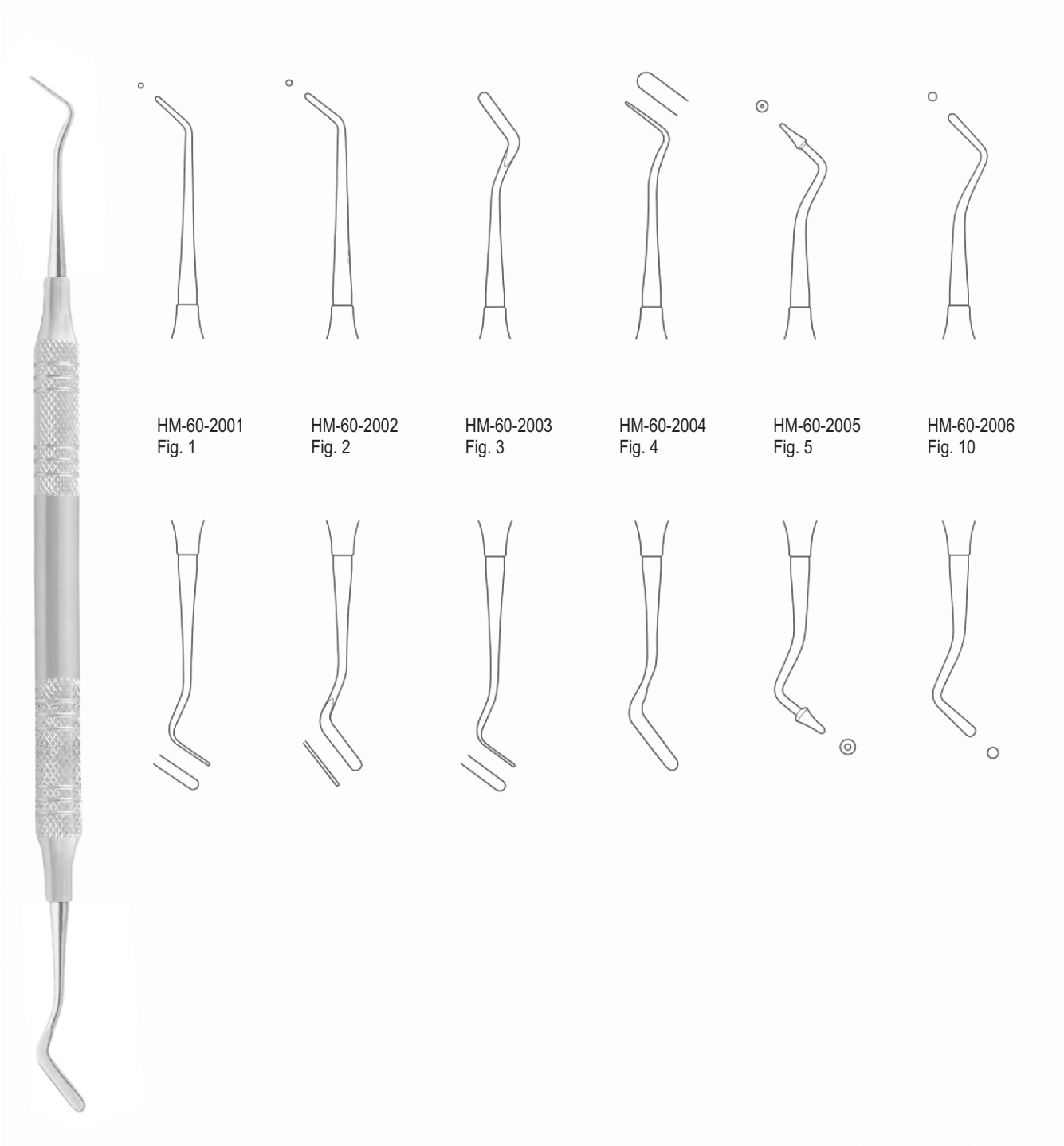
MOMAD DENTAL SUPPLIES

60

- EN** Filling Instruments
- DE** Füllungsinstrumente
- ES** Actos de llenado
- FR** Instruments de remplissage
- IT** Strumenti di riempimento

Page 95 to 105





HM-60-2001
Fig. 1

HM-60-2002
Fig. 2

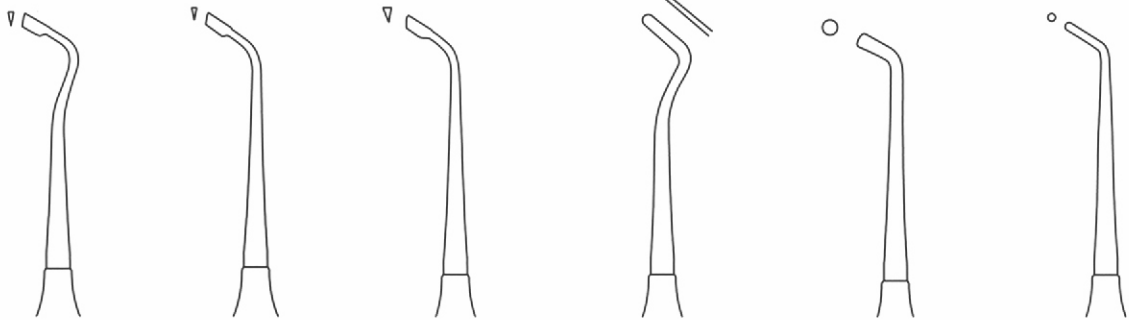
HM-60-2003
Fig. 3

HM-60-2004
Fig. 4

HM-60-2005
Fig. 5

HM-60-2006
Fig. 10

Note: Titanium Coated Points are available on customer demand.



HM-60-2007
 Fig. 1
 Felt

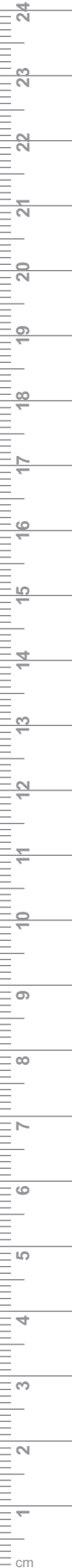
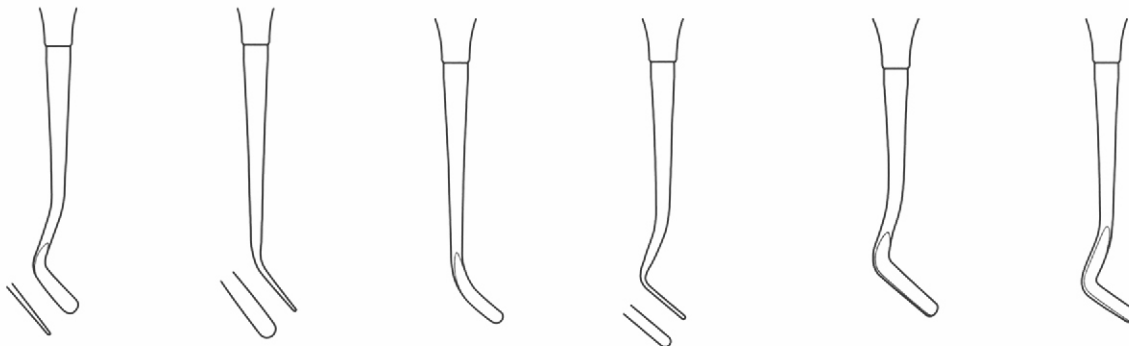
HM-60-2008
 Fig. 2
 Felt

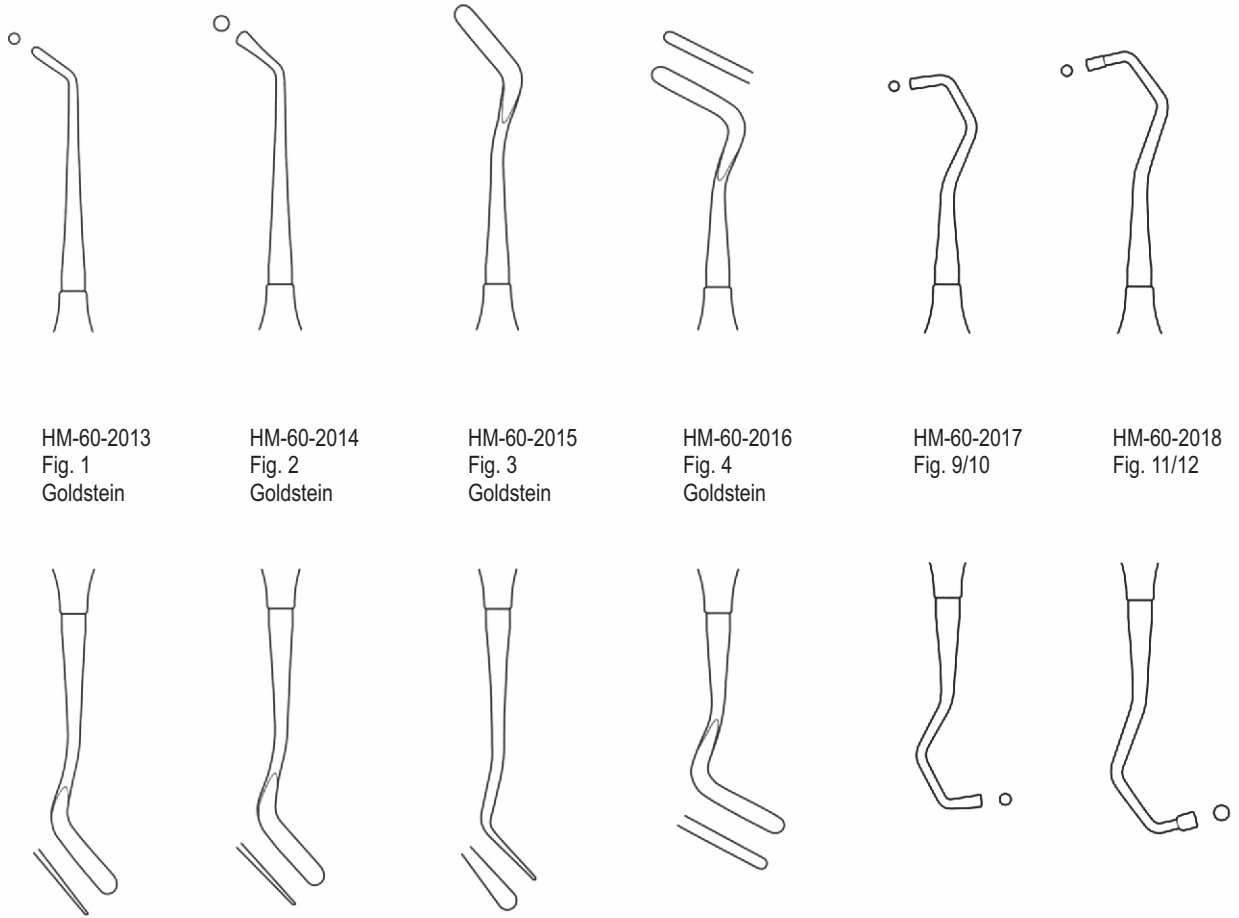
HM-60-2009
 Fig. 3
 Felt

HM-60-2010
 Fig. 4
 Felt

HM-60-2011
 Fig. 5
 Felt

HM-60-2012
 Fig. 6
 Felt





HM-60-2013
Fig. 1
Goldstein

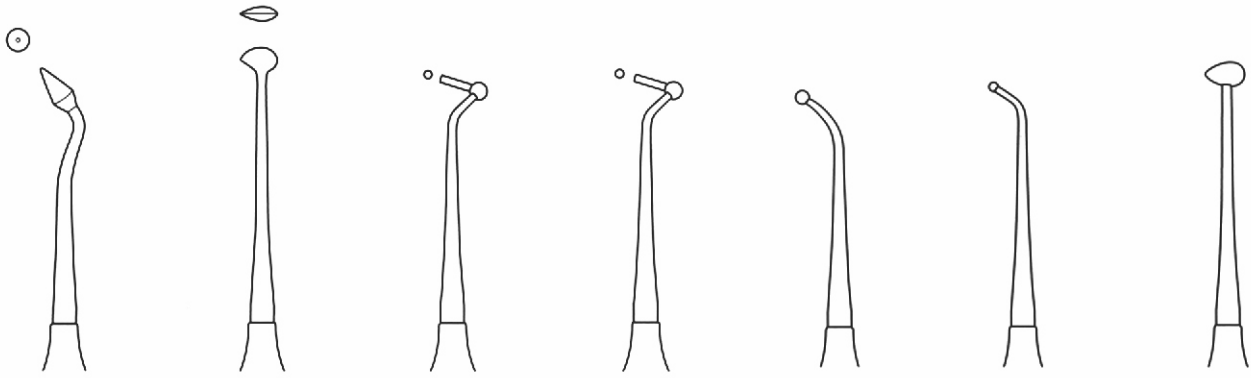
HM-60-2014
Fig. 2
Goldstein

HM-60-2015
Fig. 3
Goldstein

HM-60-2016
Fig. 4
Goldstein

HM-60-2017
Fig. 9/10

HM-60-2018
Fig. 11/12



HM-60-2019
Fig. SB

HM-60-2020
Fig. 29/2B

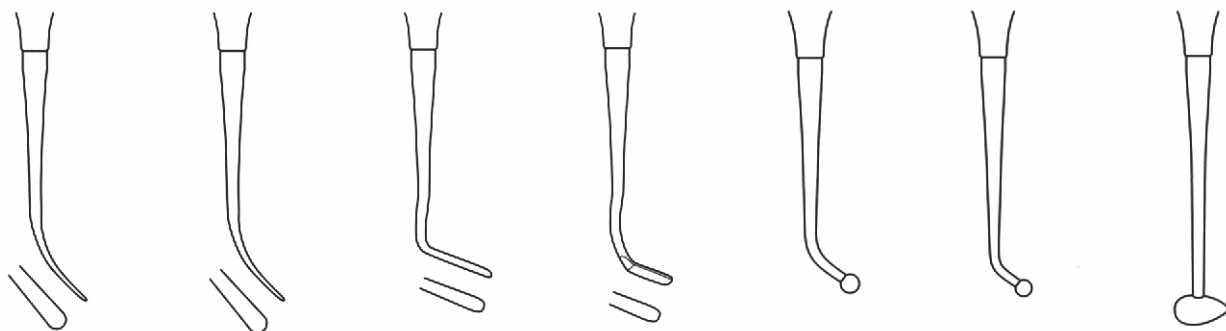
HM-60-2021
Fig. L1
Loesche

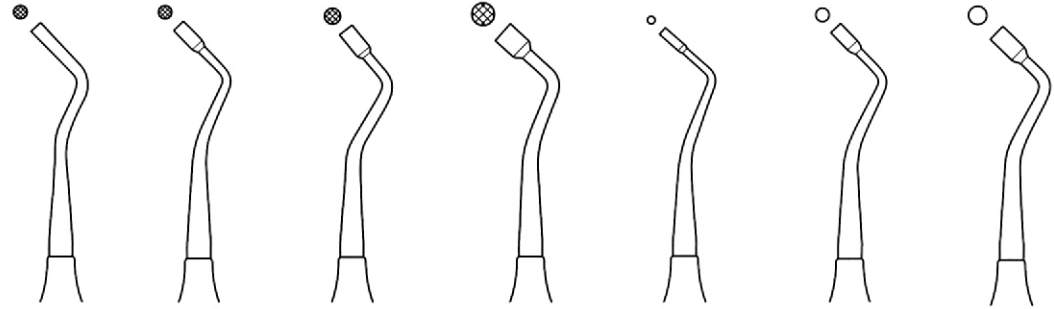
HM-60-2022
Fig. L2
Loesche

HM-60-2023
Fig. 18
Ball Burnisher

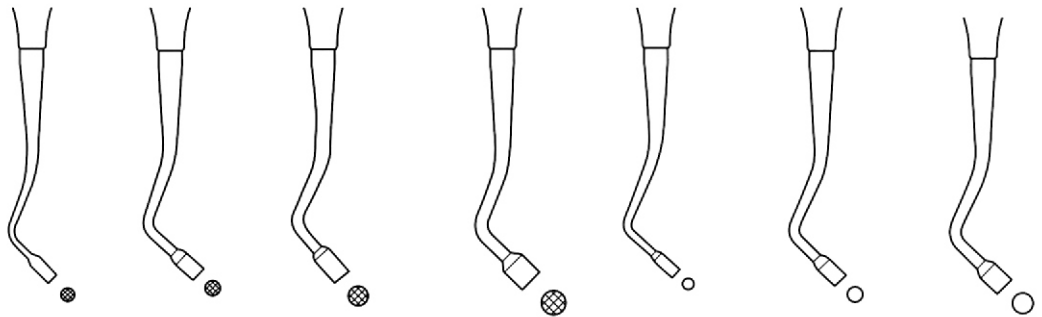
HM-60-2024
Fig. 26/27S
Ball Burnisher

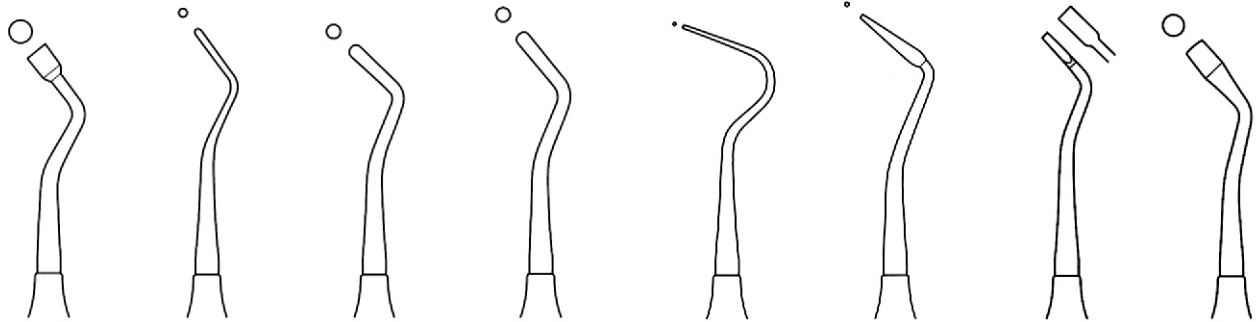
HM-60-2025
Fig. 28/29
Ball Burnisher





HM-60-2026 Fig. 1S HM-60-2027 Fig. 2S HM-60-2028 Fig. 3S HM-60-2029 Fig. 4S HM-60-2030 Fig. 1P HM-60-2031 Fig. 2P HM-60-2032 Fig. 3P





HM-60-2033
Fig. 4P

HM-60-2034
Fig. 1D

HM-60-2035
Fig. 2D

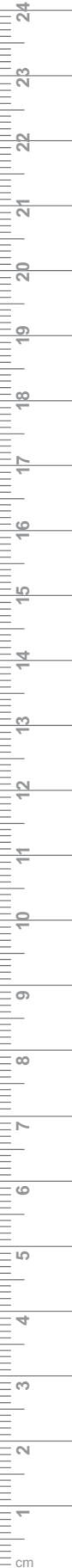
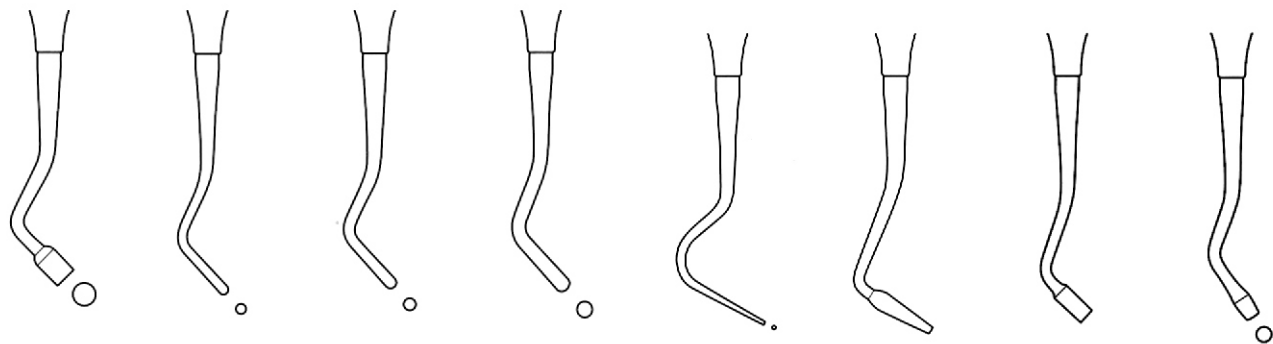
HM-60-2036
Fig. 3D

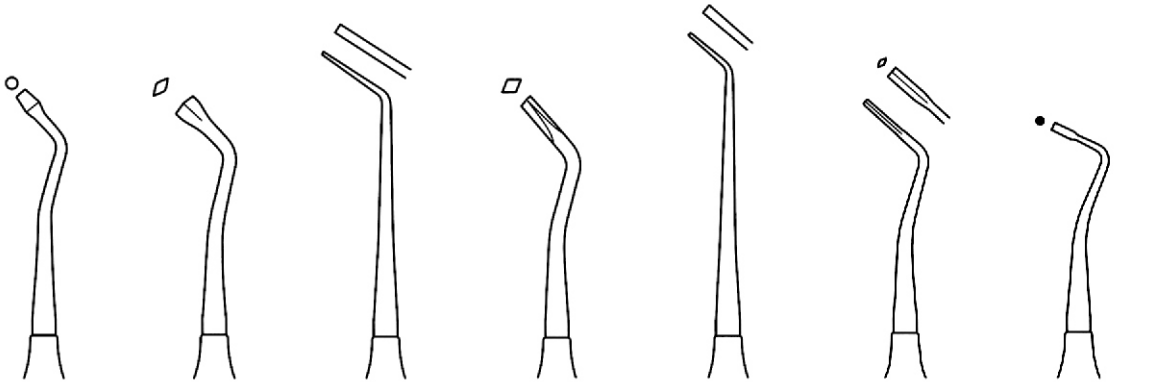
HM-60-2037
Fig. M1
Markley

HM-60-2038
Fig. M2

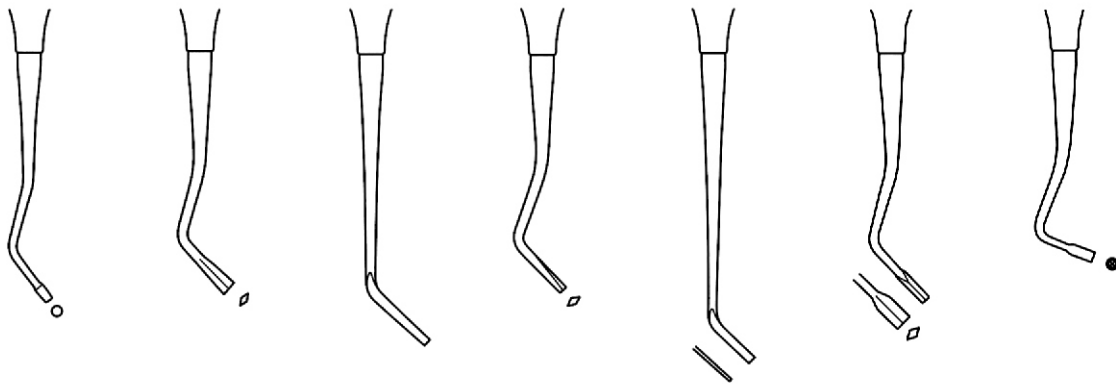
HM-60-2039
Fig. M3

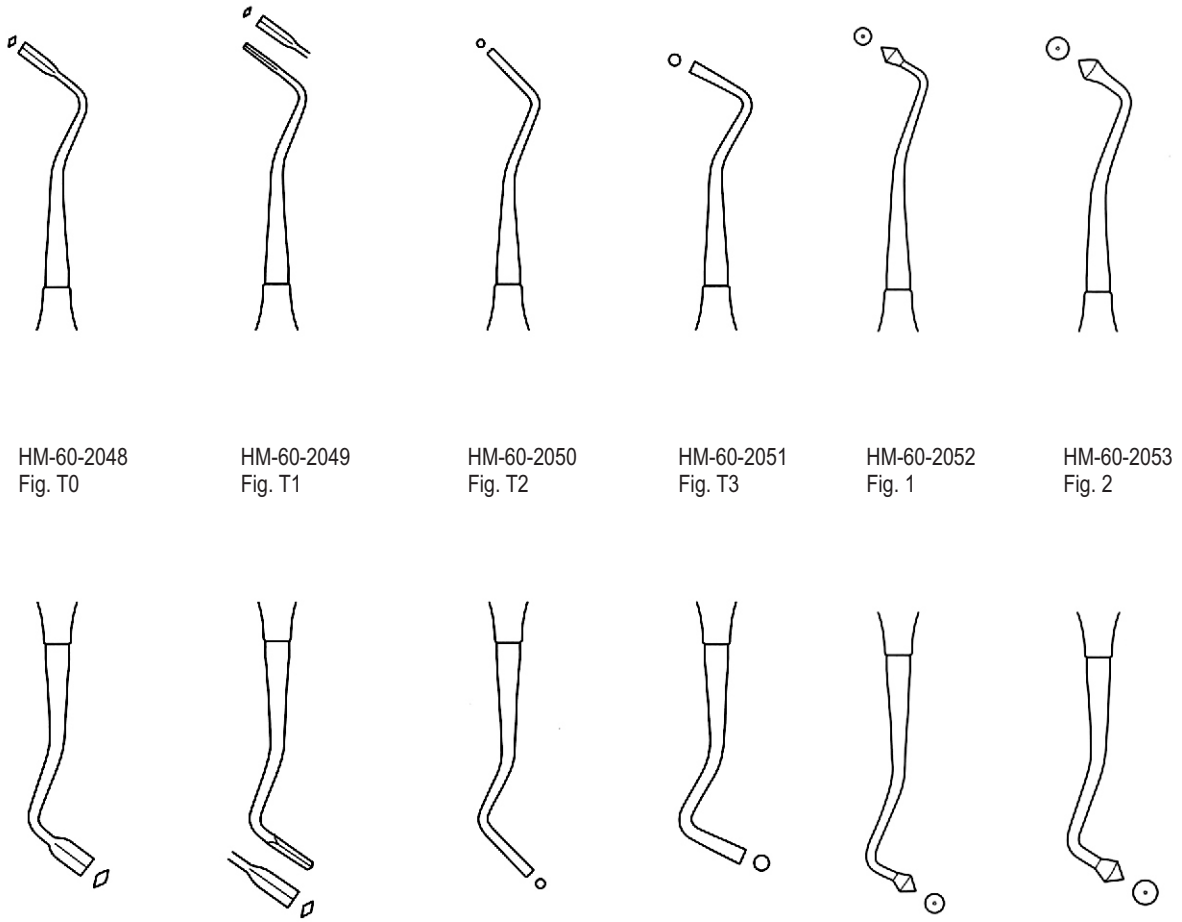
HM-60-2040
Fig. M4





HM-60-2041 Fig. M5
 HM-60-2042 Fig. M6
 HM-60-2043 Fig. H1 Hollenback
 HM-60-2044 Fig. H2 Hollenback
 HM-60-2045 Fig. H3 Hollenback
 HM-60-2046 Fig. H4 Hollenback
 HM-60-2047 Fig. MQ 1S





HM-60-2048
Fig. T0

HM-60-2049
Fig. T1

HM-60-2050
Fig. T2

HM-60-2051
Fig. T3

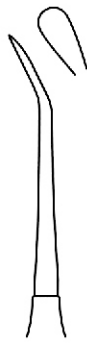
HM-60-2052
Fig. 1

HM-60-2053
Fig. 2





HM-60-2054
Fig. 3



HM-60-2055
Fig. WO 1
Woodson



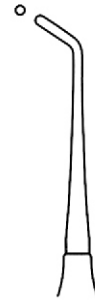
HM-60-2056
Fig. WO 2
Woodson



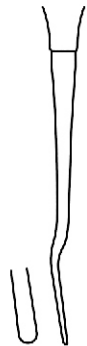
HM-60-2057
Fig. WO 3
Woodson

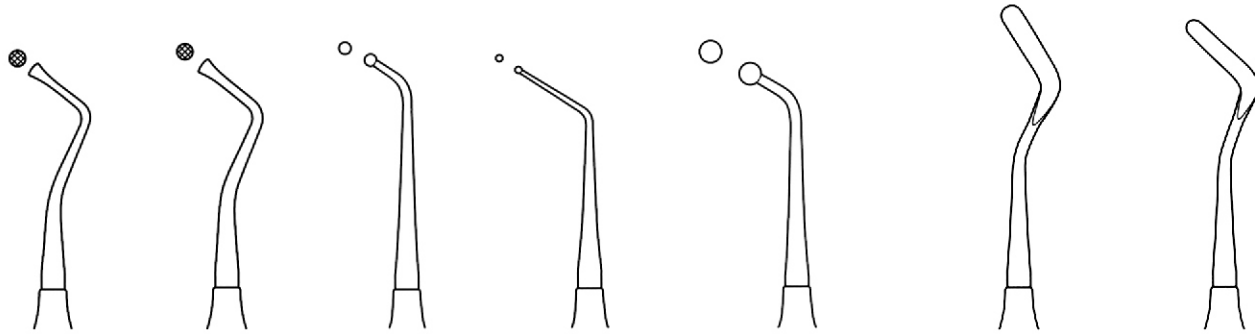


HM-60-2058
Fig. L2
Ladmore



HM-60-2059
Fig. L3
Ladmore





HM-60-2060
 Fig. 1
 Ward

HM-60-2061
 Fig. 2
 Ward

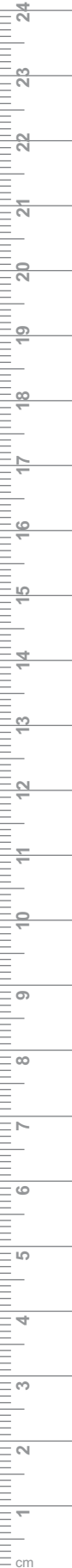
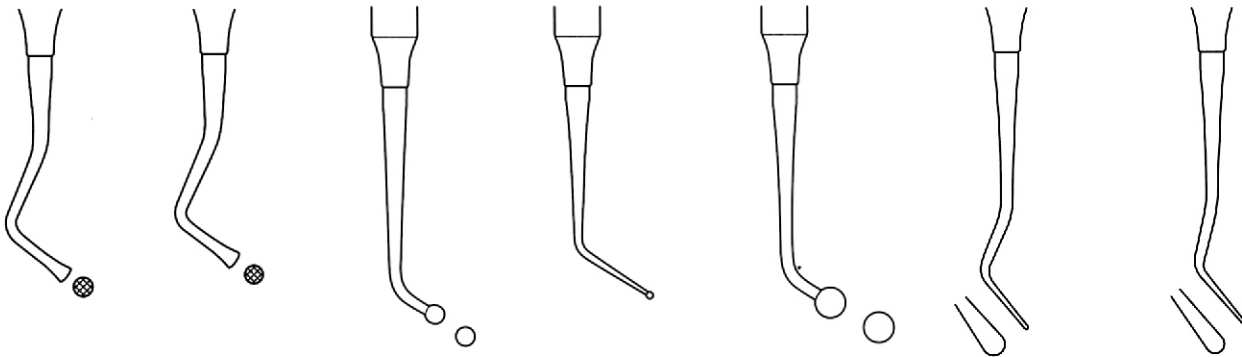
HM-60-2062
 Fig. 7A

HM-60-2063
 Fig. 19

HM-60-2064
 Fig. 7B

HM-60-2065
 Fig. 6

HM-60-2066
 Fig. 11





HM-60-2067
Fig. 179



HM-60-2068
Fig. 1
2 mm



HM-60-2069
Fig. 2
2.5 mm



HM-60-2070
Fig. 3
3 mm



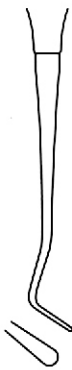
HM-60-2071
Fig. 11



HM-60-2072
Fig. 12



HM-60-2073
Fig. 13



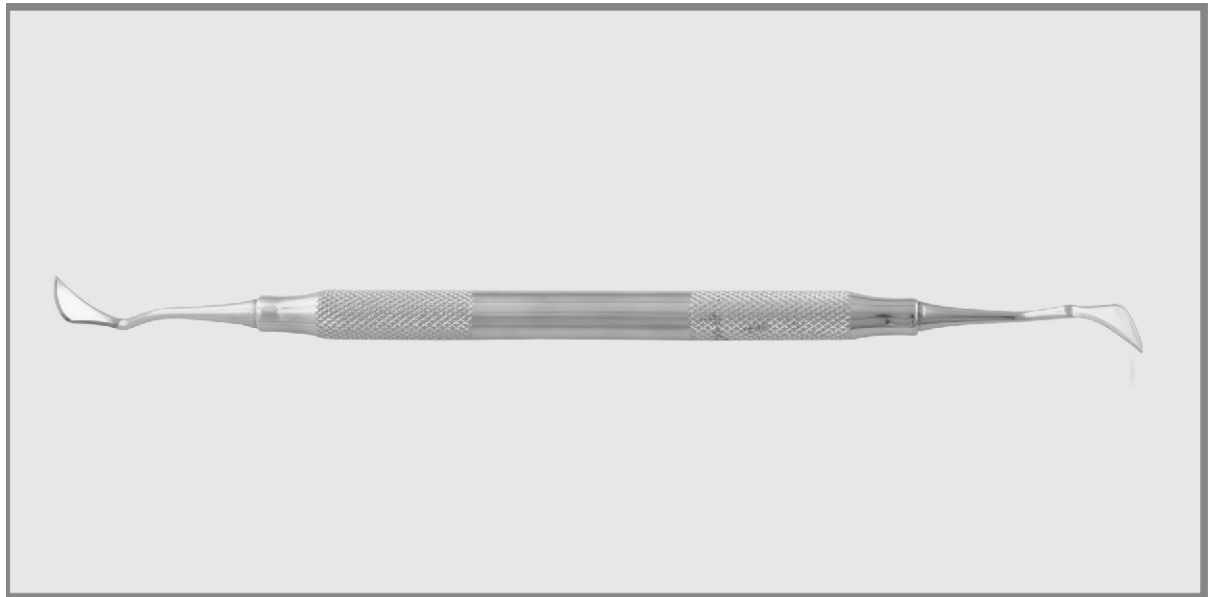


MOMAD DENTAL SUPPLIES

61

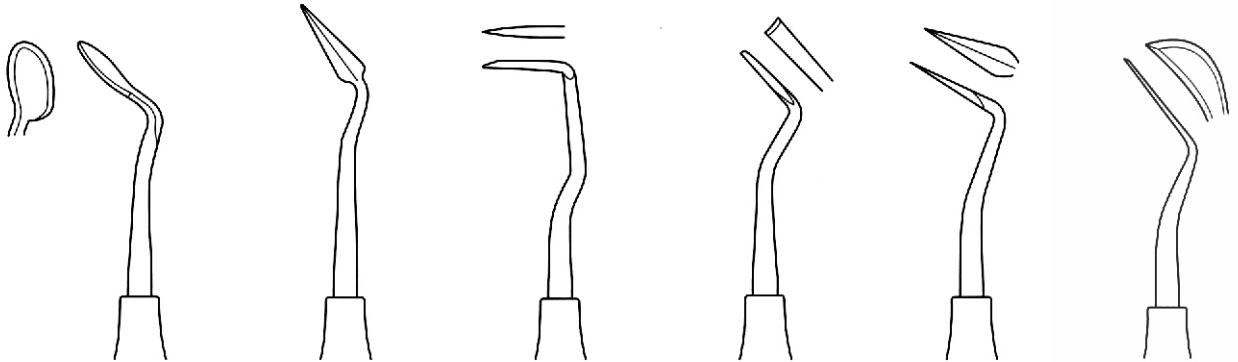
- EN** Gingivectomy Knives
- DE** Gingivektomie Messer
- ES** Cuchillos de gingivectomía
- FR** Couteaux de gingivectomie
- IT** Coltelli per gengivectomia

Page 106 to 107





- EN —●— Periodontal Knives
- DE —●— Parodontale Messer
- ES —●— Cuchillos periodontales
- FR —●— Couteaux parodontaux
- IT —●— Coltelli periodontali



HM-61-2101
Goldman-Fox
Fig. 7

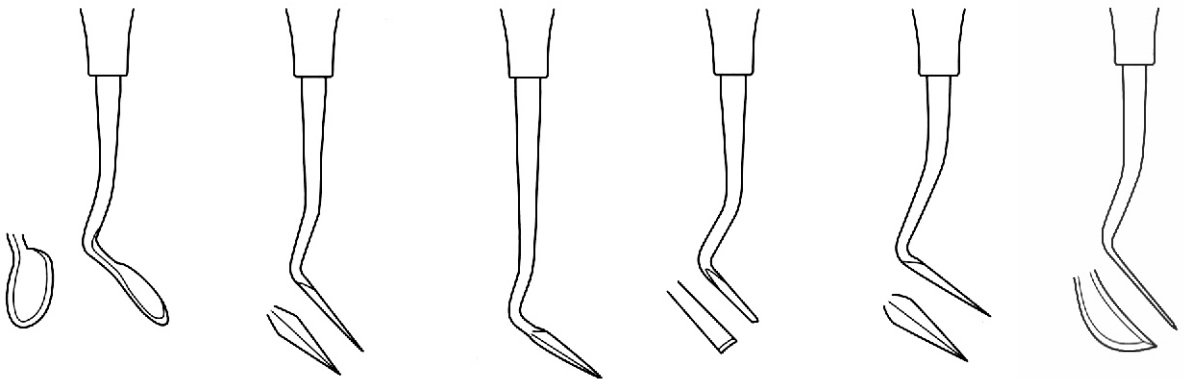
HM-61-2102
Goldman-Fox
Fig. 8

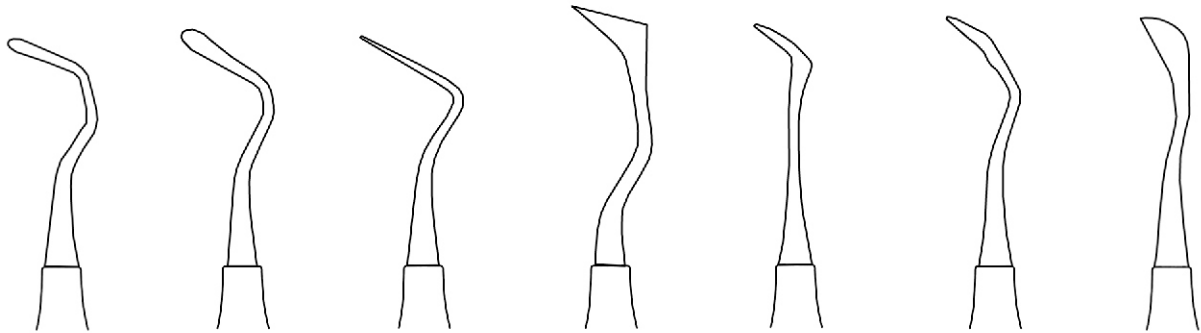
HM-61-2103
Goldman-Fox
Fig. 9

HM-61-2104
Goldman-Fox
Fig. 10

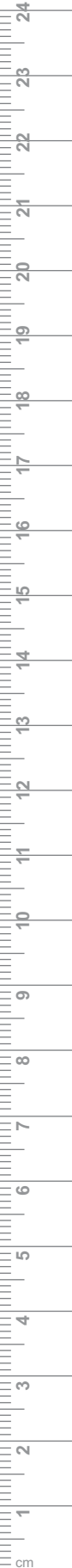
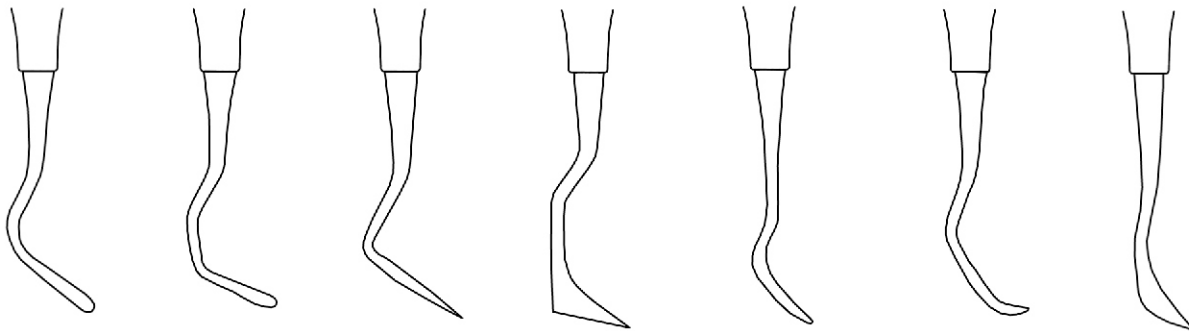
HM-61-2105
Goldman-Fox
Fig. 11

HM-61-2106
Kirkland
Fig. 15K/16K





HM-61-2107 Fig. 1 Reddy Thin	HM-61-2108 Fig. 2 Reddy Thin	HM-61-2109 Fig. 1/2 Sanders	HM-61-2110 Fig. 19/20 USC Towner	HM-61-2111 Fig. CK-3 Crane Kaplan	HM-61-2112 Fig. CK-6 Crane Kaplan	HM-61-2113 Fig. 1/2 Solt
------------------------------------	------------------------------------	-----------------------------------	--	---	---	--------------------------------



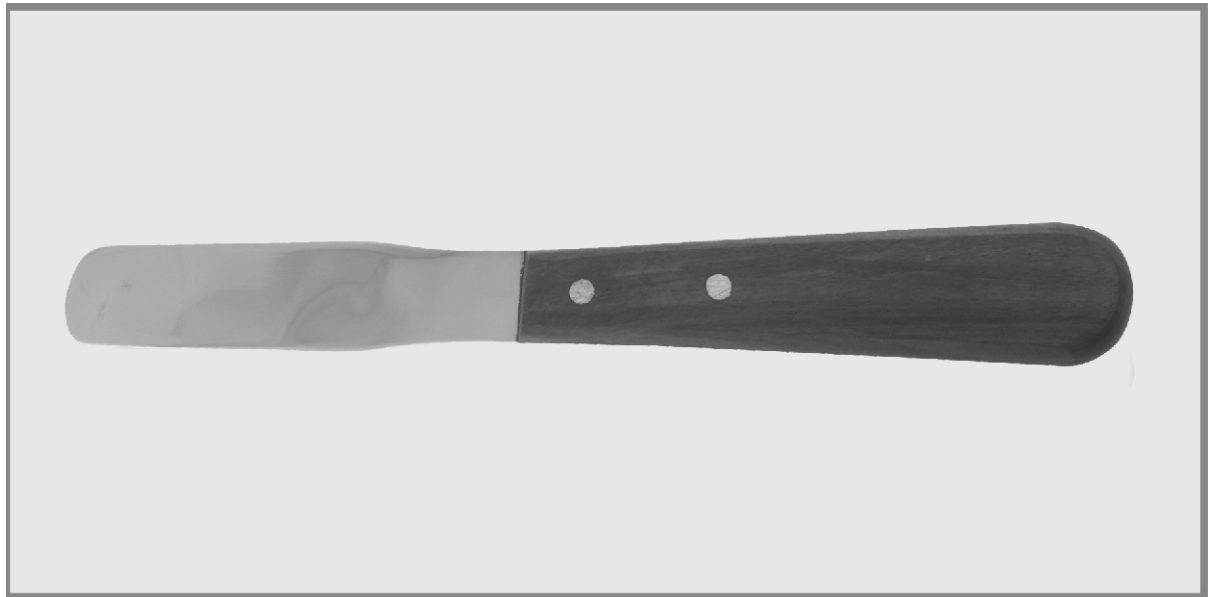


MOMAD DENTAL SUPPLIES

62

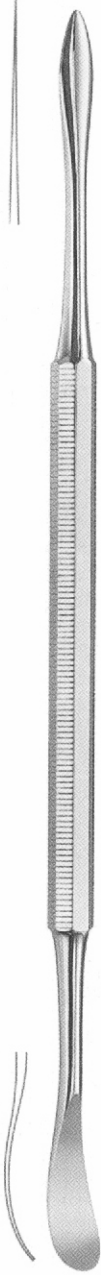
EN	Cement Spatulas
DE	Zementspatel
ES	Espátulas de cemento
FR	Spatules de ciment
IT	Spatole di cemento

Page 108 to 112

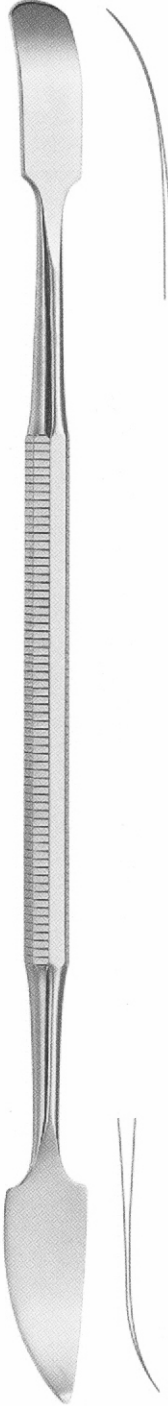




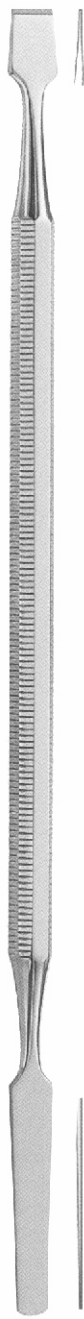
- EN —●— Cement Spatulas
- DE —●— Zementspatel
- ES —●— Espátulas de cemento
- FR —●— Spatules de ciment
- IT —●— Spatole di cemento



HM-62-2151
Fig. 26
Distal



HM-62-2152
Fig. 27
Mesial



HM-62-2153
Fig. 29
Mesial



HM-62-2154
Fig. 29
Mesial



HM-62-2155
Fig. 77/78
Distal



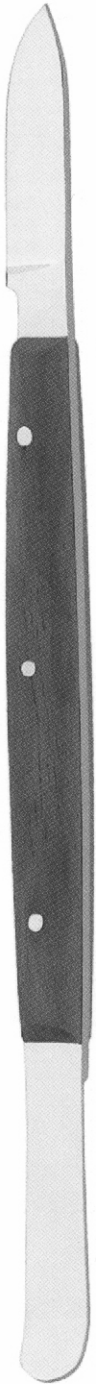
HM-62-2156
Mesial
54-1142-00



HM-62-2157
Fig. 28
Distal



Wooden Handle



HM-62-2158
 Fig. 28
 Distal



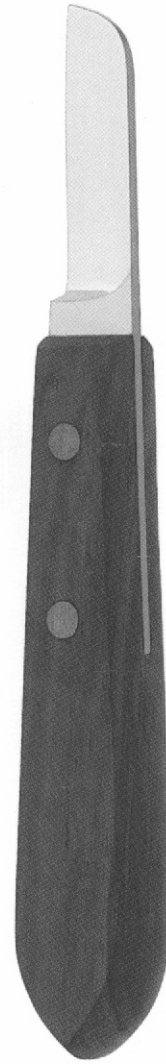
HM-62-2159
 Fig. 28
 Distal



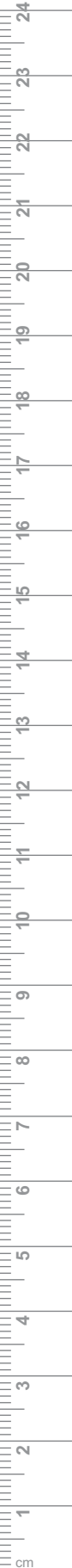
HM-62-2160
 Fig. 28
 Distal



HM-62-2161
 Fig. 28
 Distal



HM-62-2162
 Fig. 28
 Distal





HM-62-2163
Fig. 1



Fig. 2



Fig. 3



Fig. 4

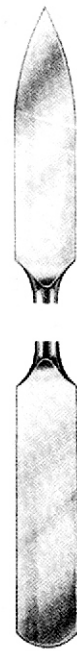


Fig. 5



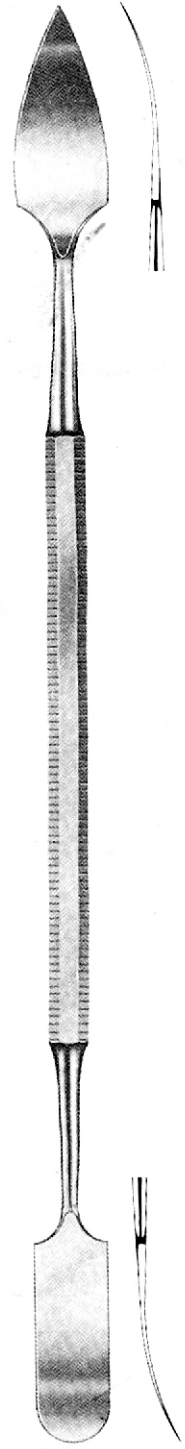
Fig. 1



Fig. 2
HM-62-2164



Fig. 3



HM-62-2165
Fig. 31
Gritman



HM-62-2166
Fig. 1

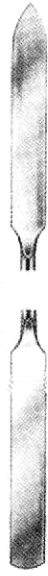


Fig. 2



Fig. 3



HM-62-2167
Fig. 1

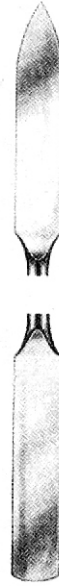


Fig. 2



Fig. 5



Fig. 3



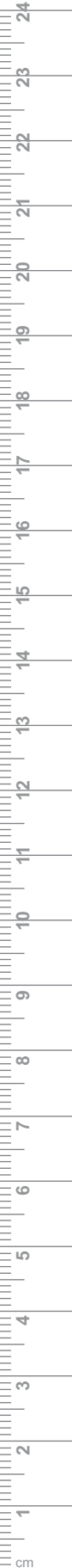
Fig. 6



Fig. 4



Fig. 7





- EN —●— Cement Spatulas
- DE —●— Zementspatel
- ES —●— Espátulas de cemento
- FR —●— Spatules de ciment
- IT —●— Spatole di cemento



HM-62-2168
Fig. 1



Fig. 2



Fig. 4



Fig. 5



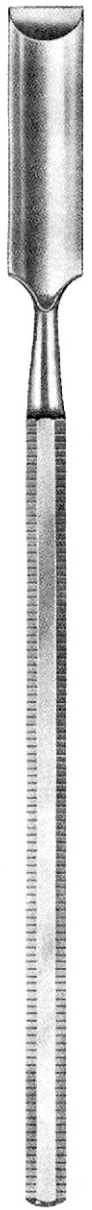
HM-62-2169
Fig. 313



Fig. 322



Fig. 324



HM-62-2170



Fig. 6



Fig. 7



Fig. 8



Fig. 24 A



Fig. 25 E



Fig. 11



Fig. 12

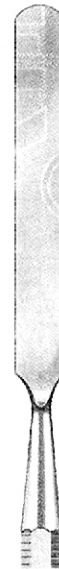


Fig. 5



Fig. 8

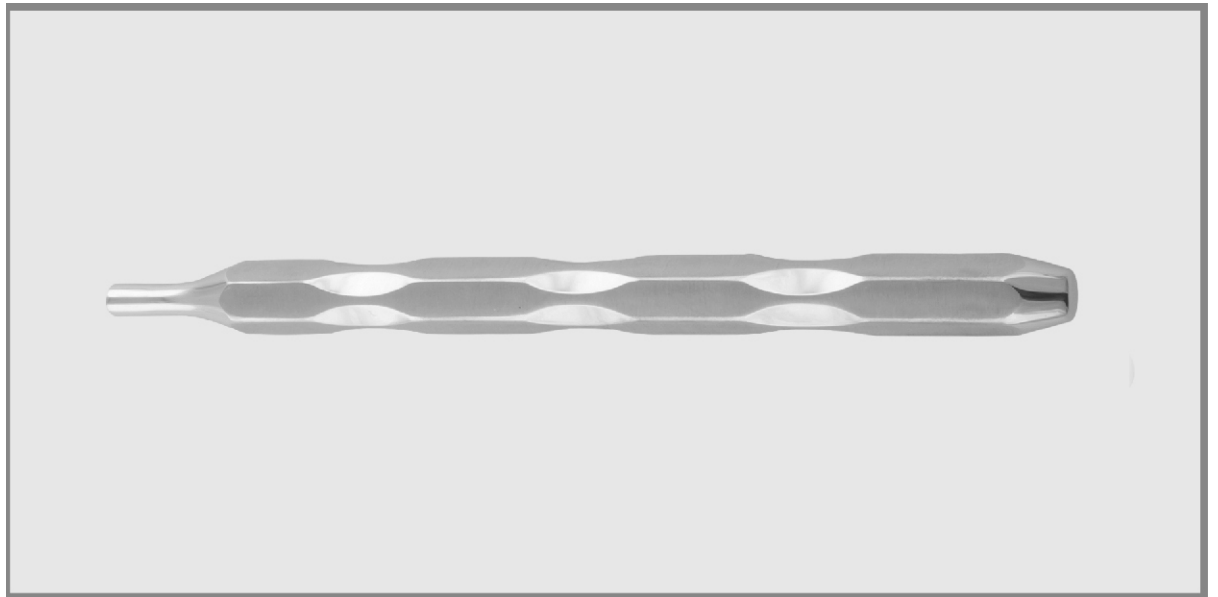


MOMAD DENTAL SUPPLIES

63

- | | |
|-----------|------------------------|
| EN | Mouth Mirrors |
| DE | Mundspiegel |
| ES | Espejos bucales |
| FR | Bouche Miroirs |
| IT | Bocca specchi |

Page 113 to 115





Simple Stem



Plain
Magnifying
Front Surface

- 1 = 16 mm HM-63-2301-16
- 3 = 20 mm HM-63-2301-20
- 4 = 22 mm HM-63-2301-22
- 5 = 24 mm HM-63-2301-24



Plain
Magnifying
Front Surface

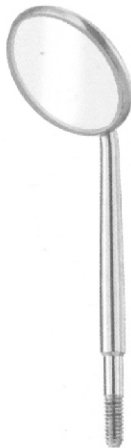
- 4 = 22 mm HM-63-2302-22
- 5 = 24 mm HM-63-2302-24



Plain
Magnifying
Front Surface

- 3 = 20 mm HM-63-2303-20
- 4 = 22 mm HM-63-2303-22
- 5 = 24 mm HM-63-2303-24

Cone Socket



Plain
Magnifying
Front Surface

- 3 = 20 mm HM-63-2304-20
- 4 = 22 mm HM-63-2304-22
- 5 = 24 mm HM-63-2304-24



Plain
Magnifying
Front Surface

- 3 = 20 mm HM-63-2305-20
- 4 = 22 mm HM-63-2305-22
- 5 = 24 mm HM-63-2305-24



HM-63-2306-01
4,5 cm/13/4

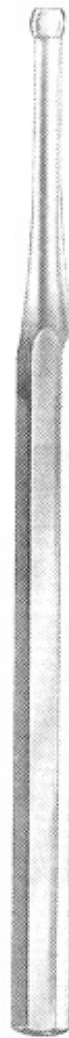


HM-63-2306-02
Handle only

HILGER
HM-63-2306-00
18 cm/7"



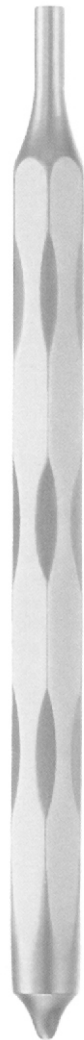
HM-63-2307-14
Hollow



HM-63-2308-14
Hollow



HM-63-2309-14
Hollow



HM-63-2310-14
Hollow



Mirror handles are available with Cone Socket and Simple Stem Fittings
 Matric / US Threads, Please specify while ordering



- EN — Mouth mirror handles
- DE — Mundspiegelgriff
- ES — Manches pour miroirs à bouche
- FR — Mangos para espejos de boca
- IT — Manici per specchietti



HM-63-2311-12
Hollow



HM-63-2312-12
Solid



HM-63-2313-12
Solid



HM-63-2314-12
Solid



HM-63-2315-00
Solid



HM-63-2316-00
Hollow

Mirror handles are available with Cone Socket and Simple Stem Fittings
Metric / US Threads, Please specify while ordering

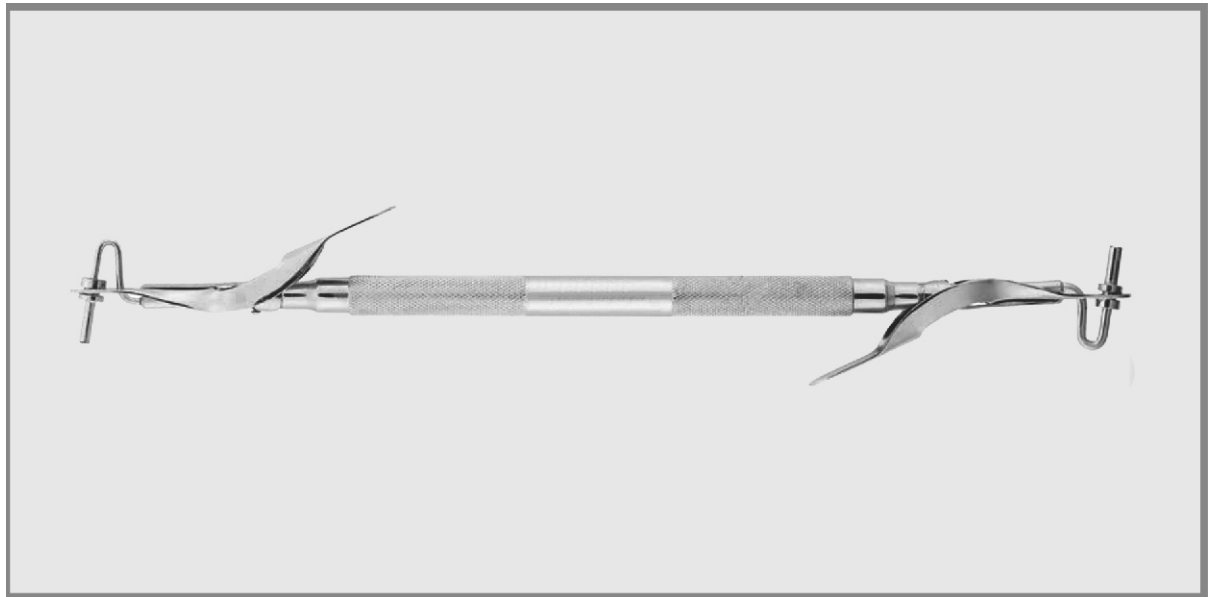


MOMAD DENTAL SUPPLIES

64

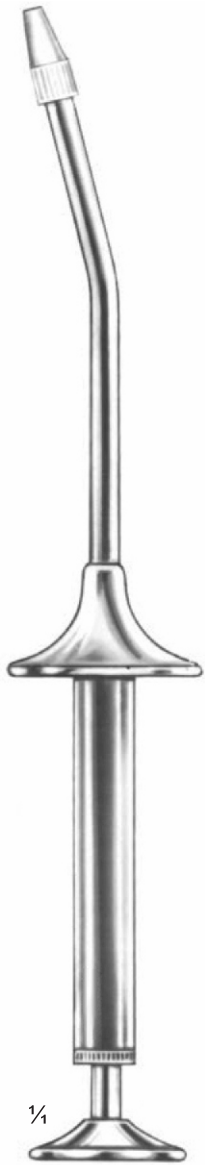
- EN** Amalgam Instruments
- DE** Amalgam Instrumente
- ES** Instrumentos de amalgama
- FR** Instruments Amalgam
- IT** Strumenti amalgama

Page 116 to 117





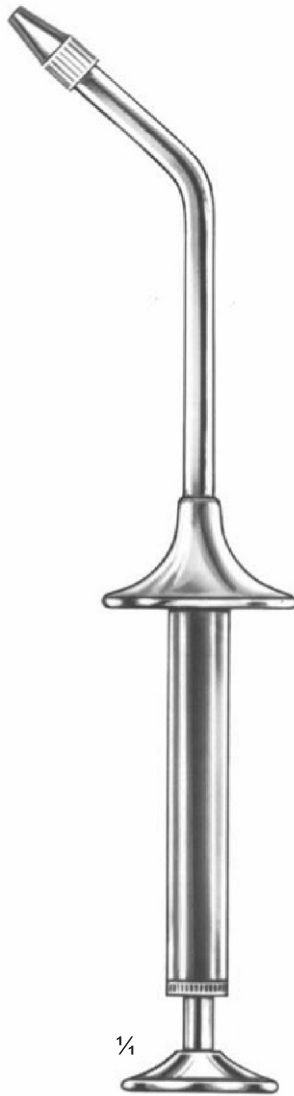
- EN —● Amalgam Guns
- DE —● Knochenfeilen
- ES —● Limes à os
- FR —● Lima para huesos
- IT —● Lima per ossa



1/4

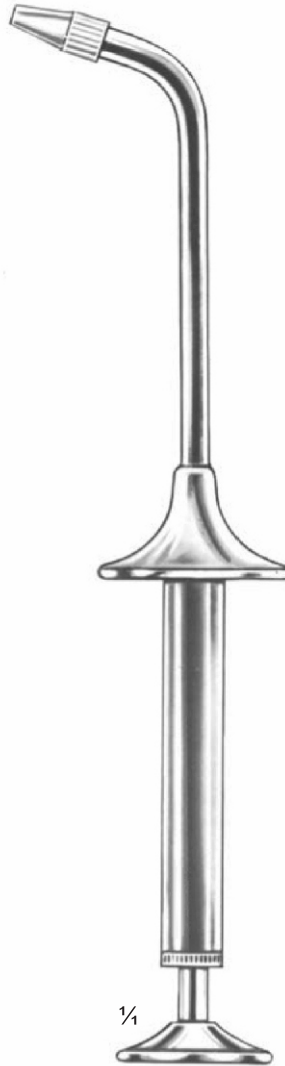
with metal tip
with plastic tip

HM-64-2351
HM-64-2352



1/4

HM-64-2353
HM-64-2354



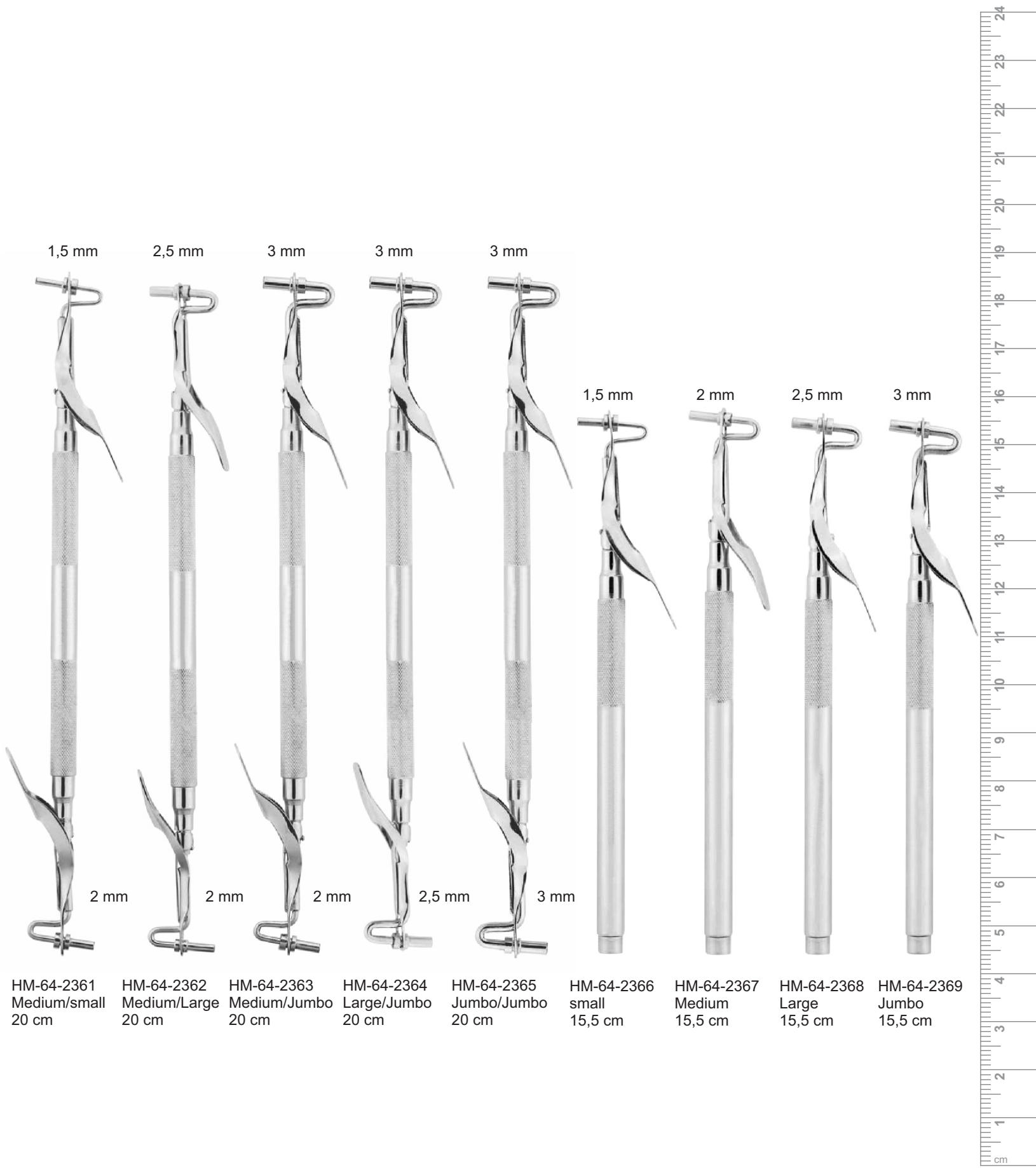
1/4

HM-64-2355
HM-64-2356



1/4

HM-64-2357
HM-64-2358



1,5 mm 2,5 mm 3 mm 3 mm 3 mm 1,5 mm 2 mm 2,5 mm 3 mm

2 mm 2 mm 2 mm 2,5 mm 3 mm

HM-64-2361 Medium/small 20 cm HM-64-2362 Medium/Large 20 cm HM-64-2363 Medium/Jumbo 20 cm HM-64-2364 Large/Jumbo 20 cm HM-64-2365 Jumbo/Jumbo 20 cm HM-64-2366 small 15,5 cm HM-64-2367 Medium 15,5 cm HM-64-2368 Large 15,5 cm HM-64-2369 Jumbo 15,5 cm

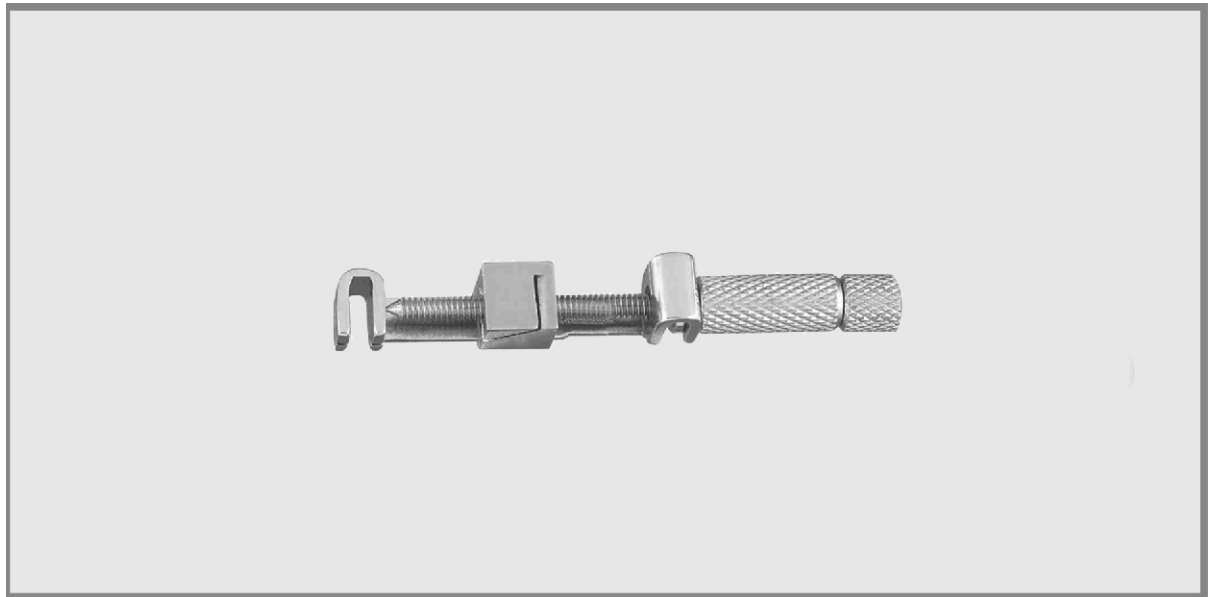


MOMAD DENTAL SUPPLIES

65

- EN** Matrix Retainers
- DE** Matrix-Halterungen
- ES** Retenedores de matrices
- FR** Retenue de matrice
- IT** Matrix Retainers

Page 118 to 125





- EN —● Matrix Retainers
- DE —● Knochenfeilen
- ES —● Limes à os
- FR —● Lima para huesos
- IT —● Lima per ossa



Tofflemire-Universal
HM-65-2601



Tofflemire-Senior
HM-65-2602



Tofflemire-Junior
HM-65-2603



Fig.1
Nystrom
left
HM-65-2604



Fig.2
Nystrom
right
HM-65-2605



Ivory 8
HM-65-2606 5 mm
HM-65-2607 6 mm
HM-65-2608 7 mm

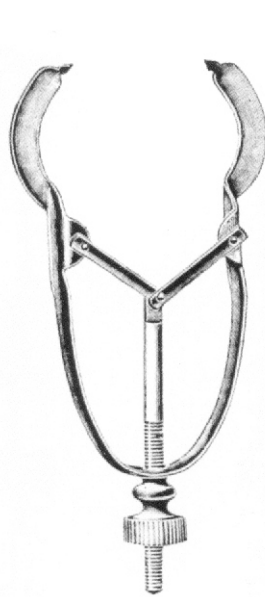


Ivory 8N
HM-65-2609

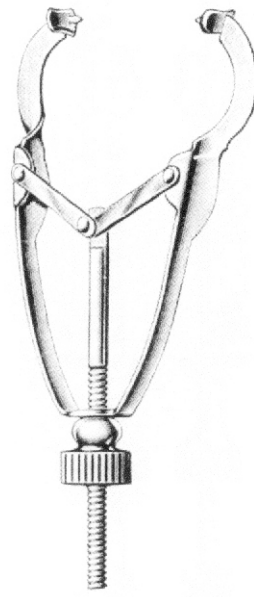


adjustable

Didner 8P
SM-65-2610



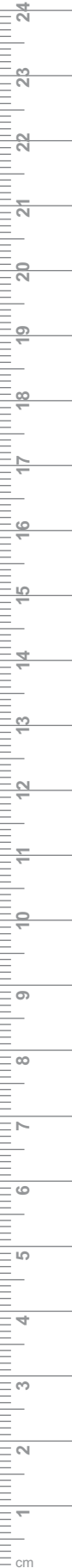
Ivory
HM-65-2611
Fig. 1



Ivory
HM-65-2612
Fig. 12



Ivory
HM-65-2613
Fig. 12A





- EN —● Rubber Dam Instruments
- DE —● Knochenfeilen
- ES —● Limes à os
- FR —● Lima para huesos
- IT —● Lima per ossa

MOMAD DENTAL SUPPLIES



Ainsworth
HM-65-2614
16 cm / 6 1/2"



Ainsworth
HM-65-2615
16 cm / 6 1/2"



Ivory
HM-65-2616
15 cm / 6"



Ivory
HM-65-2617
15 cm / 6"



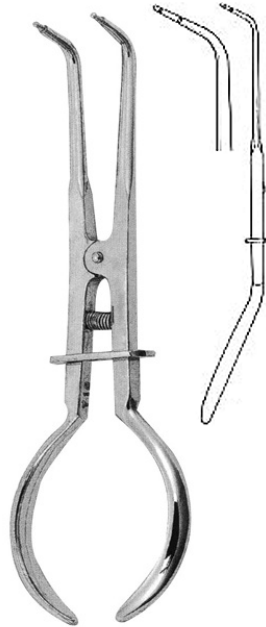
Ivory
HM-65-2618
17 cm / 6 3/4"



Brewer
HM-65-2619
17 cm / 6 3/4"



Stockes
 HM-65-2620
 17 cm / 6 3/4"



Stockes
 HM-65-2621
 17 cm / 6 3/4"



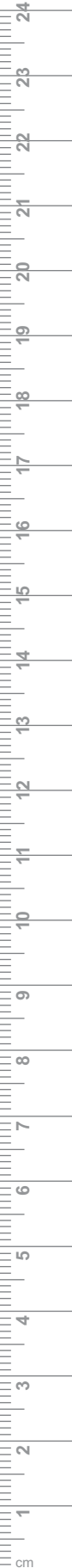
Palmer
 HM-65-2622
 17 cm / 6 3/4"



White
 HM-65-2623
 17 cm / 6 3/4"



Band Pusher-Mershon
 HM-65-2624
 14 cm / 5 1/2"





- EN —● Rubber Dam Instruments
- DE —● Knochenfeilen
- ES —● Limes à os
- FR —● Lima para huesos
- IT —● Lima per ossa

MOMAD DENTAL SUPPLIES



HM-65-2626
Fig. 00
Anterior Teeth



HM-65-2627
Fig. 0
Premolars



HM-65-2628
Fig. 1
Premolars



HM-65-2629
Fig. 1A
Premolars



HM-65-2630
Fig. 2
Premolars



HM-65-2631
Fig. 2A
Premolars



HM-65-2632
Fig. 2AS
Premolars



HM-65-2633
Fig. 3
Lower Molars



HM-65-2634
Fig. 4
Upper Molars



HM-65-2635
Fig. 5
Upper Molars



HM-65-2636
Fig. 6
Anterior Teeth



HM-65-2637
Fig. 7
Lower Molars



HM-65-2638
Fig. 7A
Lower Molars



HM-65-2639
Fig. 8
Upper Molars



HM-65-2640
Fig. 8A
Molars General



HM-65-2641
Fig. 9
Anterior Teeth



HM-65-2642
Fig. 9S
Anterior Teeth



HM-65-2643
Fig. 10
Molars General



HM-65-2644
Fig. 11
Molars General



HM-65-2645
Fig. 24
Molars General



HM-65-2646
Fig. 25
Molars General



HM-65-2647
Fig. 26
Lower Molars



HM-65-2648
Fig. 26N
Molars General



HM-65-2649
Fig. 27
Molars General



HM-65-2650
 Fig. 27N
 Premolars



HM-65-2651
 Fig. 28
 Lower Molars



HM-65-2652
 Fig. 29
 Lower Molars



HM-65-2653
 Fig. 30
 Upper Molars



HM-65-2654
 Fig. 31
 Upper Molars



HM-65-2655
 Fig. 56
 Molars General



HM-65-2656
 Fig. 56S
 Molars General



HM-65-2657
 Fig. 201
 Upper Molars



HM-65-2658
 Fig. 205
 Upper Molars



HM-65-2659
 Fig. 212
 Anterior Teeth



HM-65-2660
 Fig. 212SA
 Anterior Teeth



HM-65-2661
 Premolars
 12-06SM-65-W2



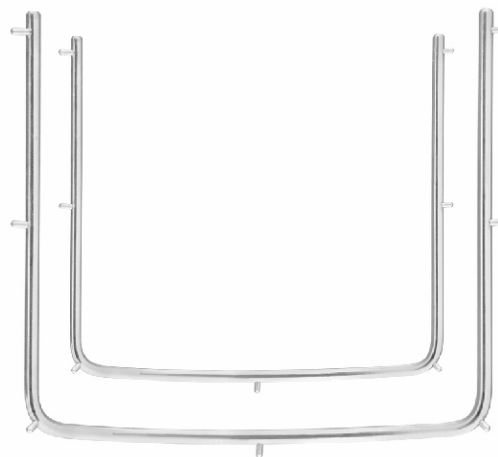
HM-65-2662
 Fig. W3
 Lower Molars



HM-65-2663
 Fig. W4
 Upper Molars



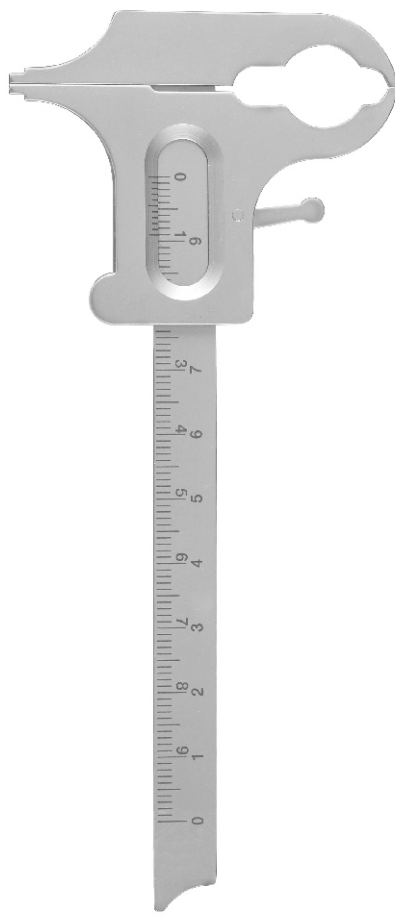
HM-65-2664
 Fig. W7
 Lower Molars



HM-65-2665 Frame - Child
 13 cm/5"
 HM-65-2666 Frame - Adult
 15 cm/6"



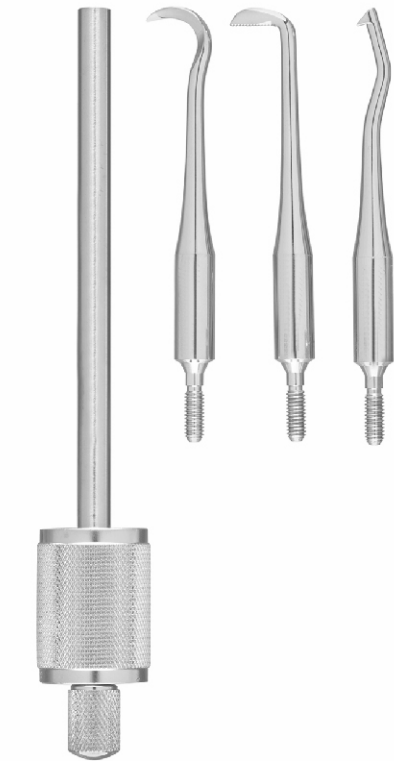
HM-65-2667 Beerendonk



HM-65-2668 Boley



Iwanson
 One side graugation
 HM-65-2669 Metal
 HM-65-2670 Wax
 Double side graugation
 SM-65-2671 Metal
 SM-65-2672 Wax



HM-65-2673
Morrel
Crown Remover



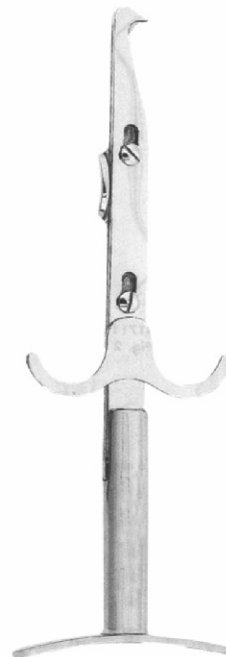
HM-65-2674
Crown Remover
Manual



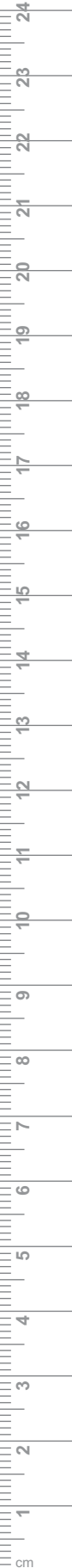
HM-65-2675
Crown Remover
Manual



HM-65-2676
Crown Remover
Automatic



HM-65-2677
Crown Remover
Automatic



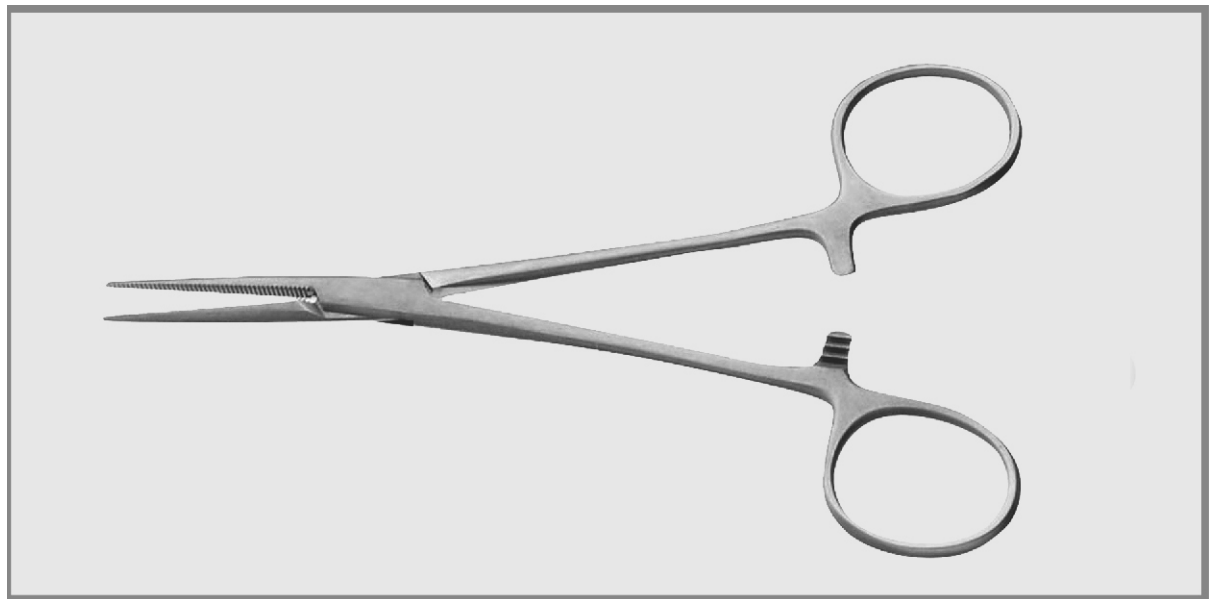


MOMAD DENTAL SUPPLIES

66

EN	Hemostatic Forceps
DE	Arterienklemmen
ES	Pinces hemostaticas
FR	Pinzashemostaticas
IT	Pinze emostatiche

Page 126 to 132





- EN —●— Artery Forceps
- DE —●— Arterienklemmen
- ES —●— Pinzas hemostáticas
- FR —●— Forceps de l'artère
- IT —●— Arteria Forcipe

MOMAD DENTAL SUPPLIES



Halsted-Mosquito



HM-66-2701
12.5 cm/5"



HM-66-2702
14.5 cm/5 ¾"



HM-66-2703
14 cm/5 ½"



HM-66-2704
12.5 cm/5"
1:2



HM-66-2705
14.5 cm/5 ¾"
1:2



HM-66-2706
12 cm/4 ¾"
1:2



HM-66-2707
14 cm/4 ½"
1:2



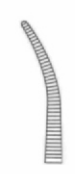
Micro-Mosquito



HM-66-2708
10 cm/4"



HM-66-2709
12 cm/4 ¾"



HM-66-2710
9.5 cm/3 ½"



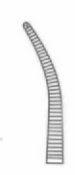
HM-66-2711
11.5 cm/4 ½"



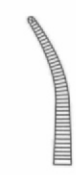
HM-66-2712
10 cm/4"
1:2



HM-66-2713
12 cm/4 ¾"
1:2



HM-66-2714
10 cm/4"
1:2



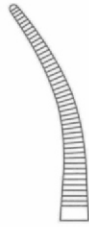
HM-66-2715
12 cm/4 ¾"
1:2



Halsted-Mosquito



HM-66-2716
18 cm/7"



HM-66-2717
18 cm/7"



HM-66-2718
18 cm/7"
1:2



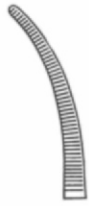
HM-66-2719
18 cm/7"
1:2



Leriche



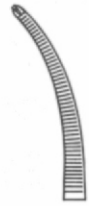
HM-66-2720
15 cm/6"



HM-66-2721
15 cm/6"



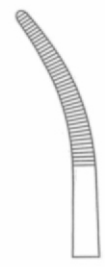
HM-66-2722
15 cm/6"
1:2



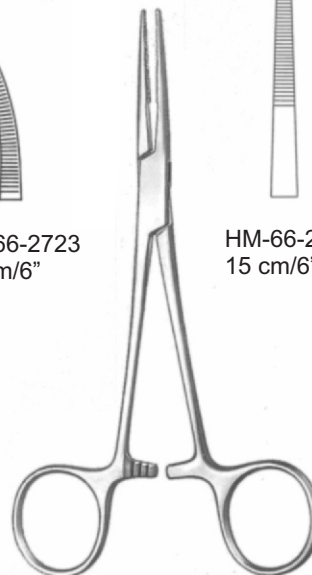
HM-66-2723
15 cm/6"
1:2



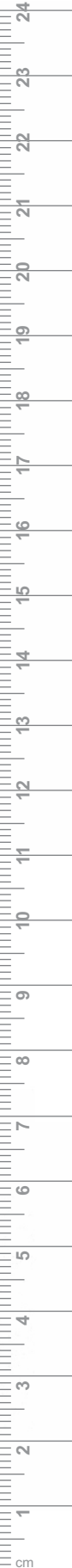
HM-66-2724
15 cm/6"



HM-66-2725
15 cm/6"

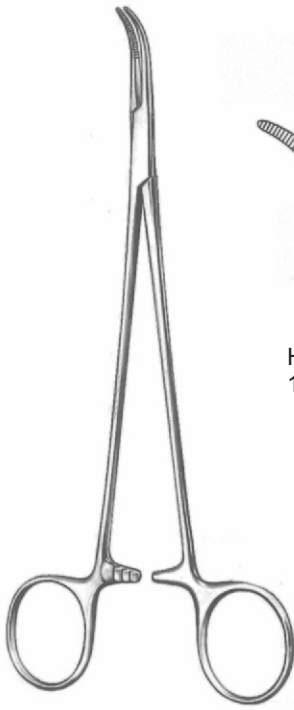


Kelly





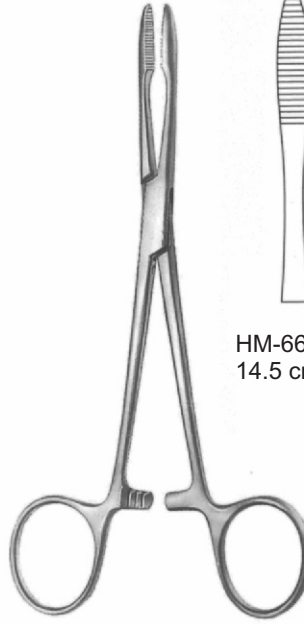
- EN —● Artery Forceps
- DE —● Arterienklemmen
- ES —● Pinzas hemostáticas
- FR —● Forceps de l'artère
- IT —● Arteria Forcipe



Mixer-Baby



HM-66-2726
18.5 cm/7 1/4"



Pean



HM-66-2727
14.5 cm/5 3/4"



HM-66-2728
16 cm/6 1/4"



Pean



HM-66-2729
13 cm/5"



HM-66-2730
14 cm/5 1/2"



HM-66-2731
17 cm/6 3/4"



HM-66-2732
13 cm/5"

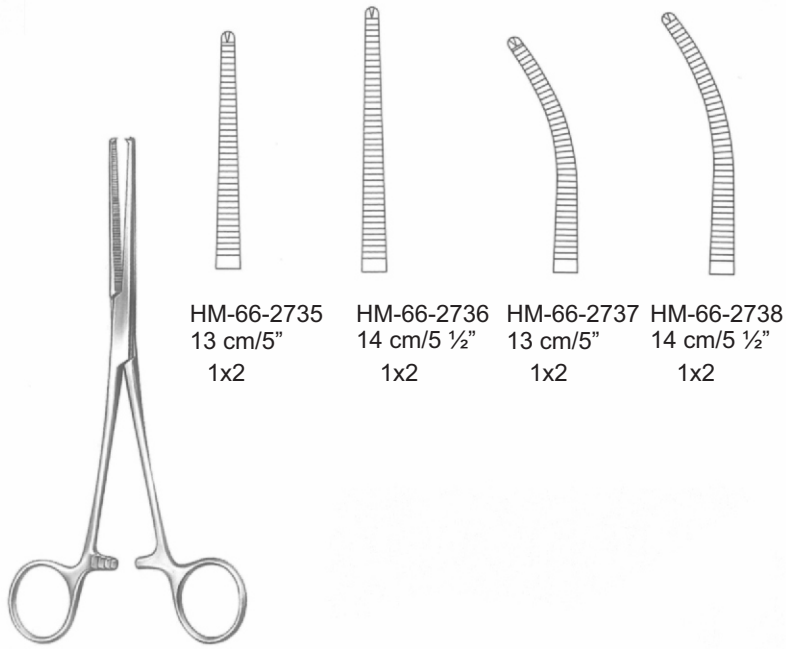


HM-66-2733
14 cm/5 1/2"



HM-66-2734
17 cm/6 3/4"





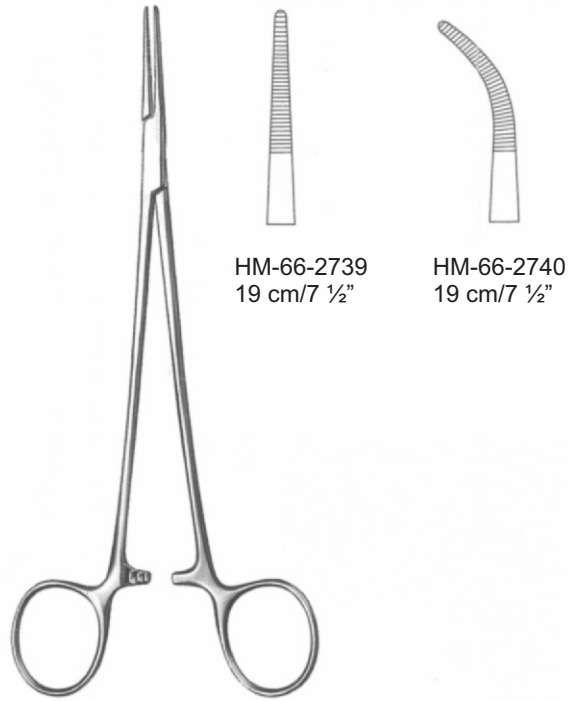
HM-66-2735
13 cm/5"
1x2

HM-66-2736
14 cm/5 1/2"
1x2

HM-66-2737
13 cm/5"
1x2

HM-66-2738
14 cm/5 1/2"
1x2

Kocher



HM-66-2739
19 cm/7 1/2"

HM-66-2740
19 cm/7 1/2"

Adson



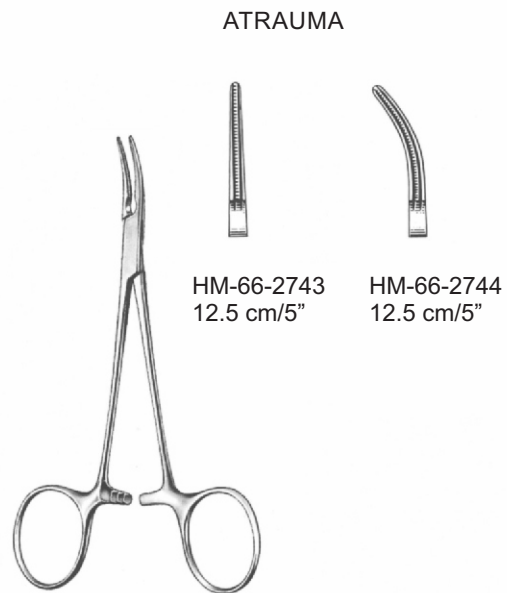
Gross-Maier



HM-66-2741
20 cm/8"



HM-66-2742
20 cm/8"

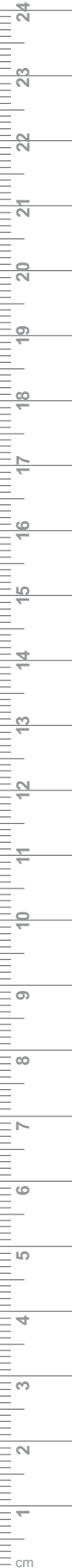


ATRAUMA

HM-66-2743
12.5 cm/5"

HM-66-2744
12.5 cm/5"

DeBakey-Mosquito



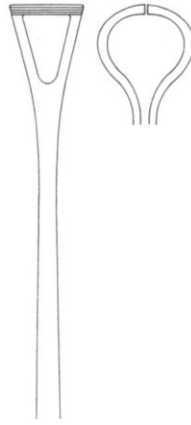


- EN —● Artery Forceps
- DE —● Arterienklemmen
- ES —● Pinzas hemostáticas
- FR —● Forceps de l'artère
- IT —● Arteria Forcipe

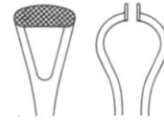


Babcock

- HM-66-2745 16 cm/6 1/4"
- HM-66-2746 18 cm/7 1/8"
- HM-66-2747 20 cm/7 7/8"
- HM-66-2748 24 cm/9 1/2"



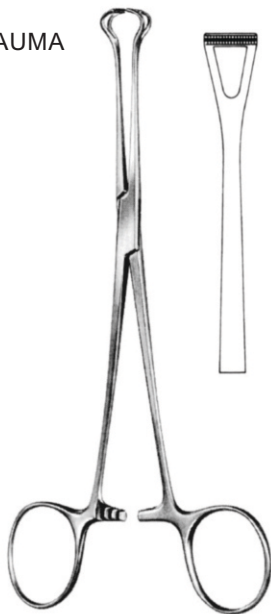
Babcock



HM-66-2749 TC
16 cm/6 1/2"



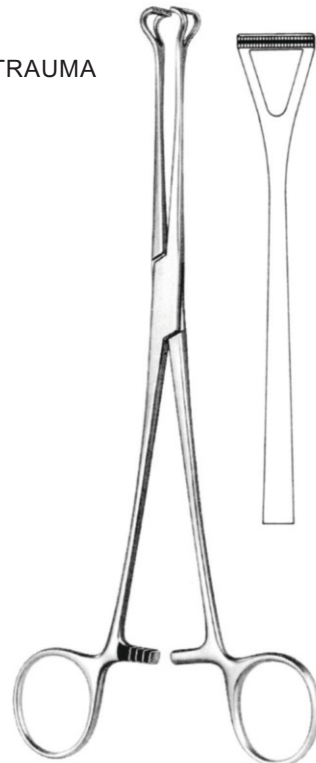
ATRAUMA



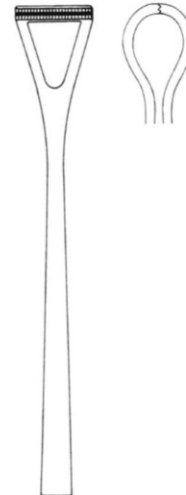
BABCOCK
HM-66-2750
16 cm/9 1/4"

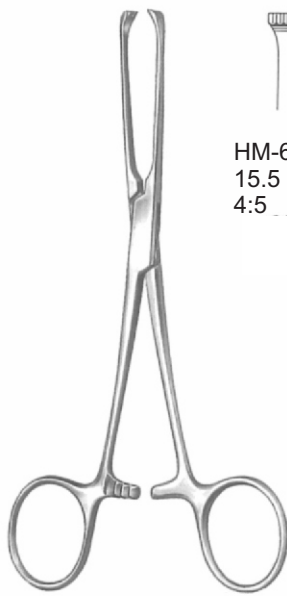


ATRAUMA



BABCOCK
HM-66-2751
20.5 cm/8 1/8"





Allis



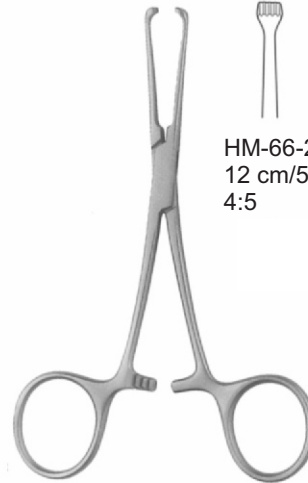
HM-66-2752
 15.5 cm/6"
 4:5



HM-66-2753
 15.5 cm/6"
 5:6



HM-66-2754
 19 cm/7 1/2"
 5:6



Allis-Baby



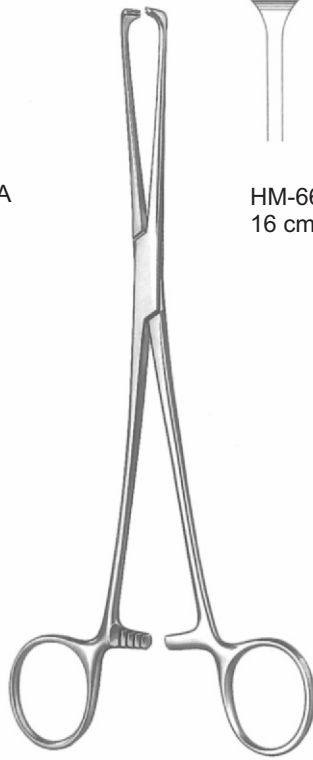
HM-66-2755
 12 cm/5"
 4:5



- EN ● Artery Forceps
- DE ● Arterienklemmen
- ES ● Pinzas hemostáticas
- FR ● Forceps de l'artère
- IT ● Arteria Forcipe



ATRAUMA



Allis



HM-66-2756
16 cm/6 1/2"



HM-66-2757
20 cm/8"

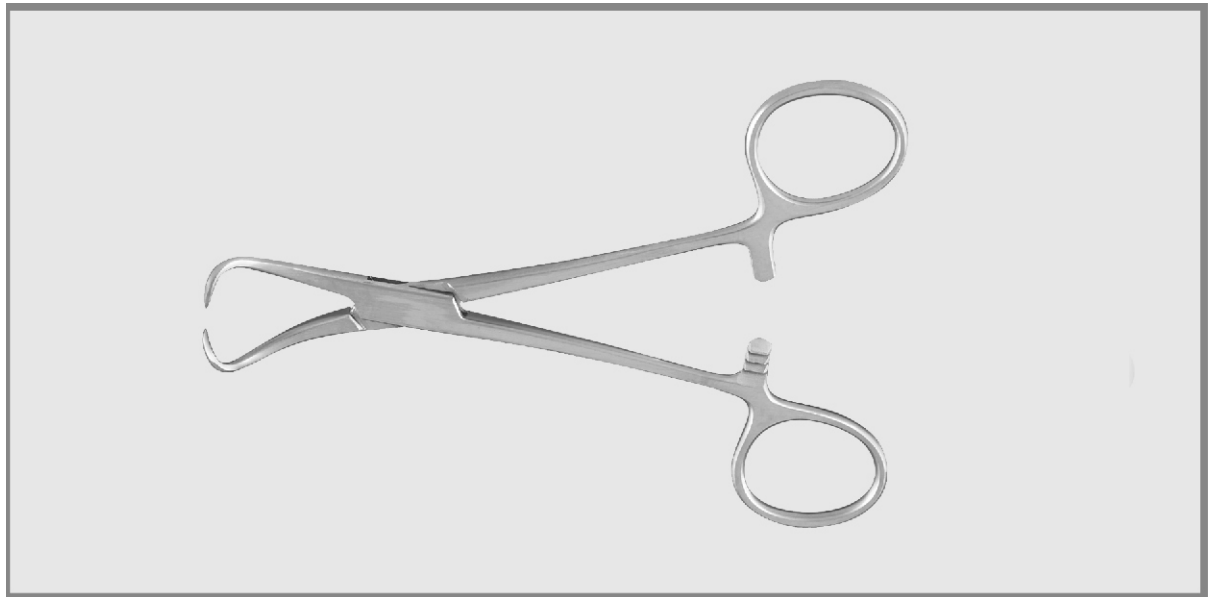


MOMAD DENTAL SUPPLIES

67

- EN** Towel Clamps
- DE** Handtuchklammern
- ES** Abrazaderas de toalla
- FR** Pincés à serviettes
- IT** Morsetti per asciugamano

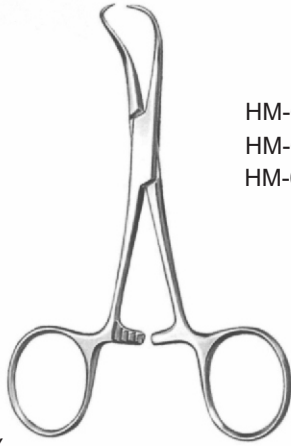
Page 133 to 134





- EN —●— Towel Clamps
- DE —●— Handtuchklammern
- ES —●— Abrazaderas de toalla
- FR —●— Pincés à serviettes
- IT —●— Morsetti per asciugamano

MOMAD DENTAL SUPPLIES



1/2

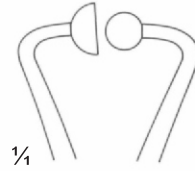
Backhaus

HM-67-2801 9 cm/3 1/2"
 HM-67-2802 11.5 cm/4 1/2"
 HM-67-2803 13 cm/5"



1/2

for paper clothes



1/4

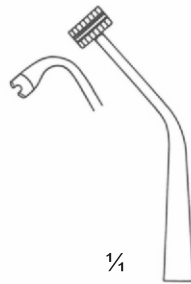
HM-67-2804
 11.5 cm/4 1/2"

HM-67-2805
 14 cm/5 1/2"

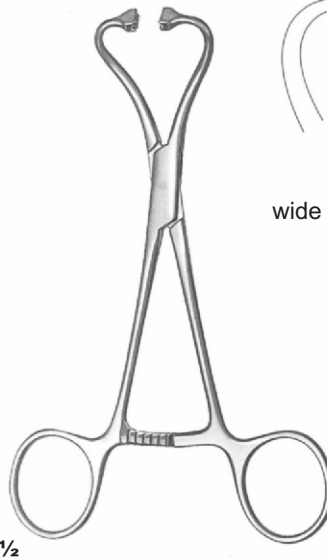


1/2

Peers-Bertrom
 HM-67-2806
 14.5 cm/5 3/4"

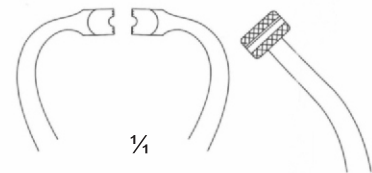


1/4



1/2

Peers-Bertram modif.
 HM-67-2807
 15.5 cm/6"



1/4

wide jaw for tube fixation



HM-67-2808
 10.5 cm/4"

HM-67-2809
 13.5 cm/5 1/4"

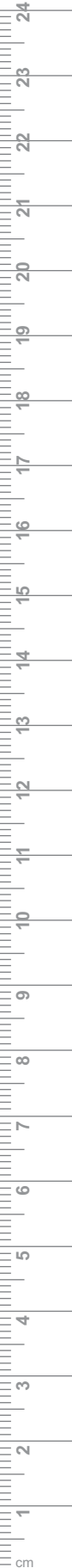


Schadel
 HM-67-2810
 8.5 cm/3 1/2"
 sharp



Jones
 sharp

HM-67-2811
 8.5 cm/3 1/4"





MOMAD DENTAL SUPPLIES

68

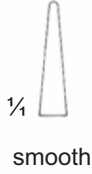
EN	Needle Holders
DE	Nadelhalter
ES	Porte-aiguilles
FR	Porta-agujcs
IT	Port' aghi

Page 135 to 143

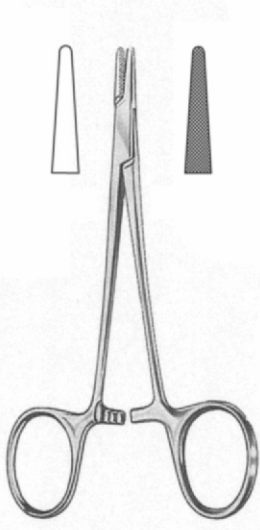




- EN —● Needle Holders
- DE —● Nadelhalter
- ES —● Porta agujas
- FR —● Porte-aiguilles
- IT —● Porta-aghi



Webster
HM-68-2901
13 cm/5 1/8"



Halsey

HM-68-2902 13 cm/5 1/8 Plain
HM-68-2903 13 cm/5 1/8 Serrated



Derf

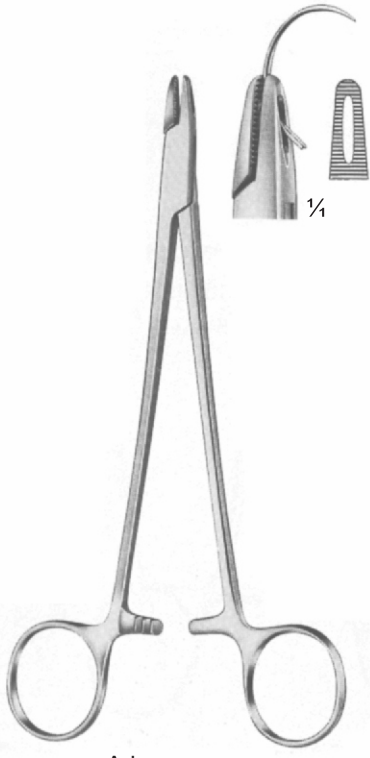
HM-68-2904
12 cm/4 3/4"
one fenestrated jaw



Crile-Wood
HM-68-2905
15 cm/5 7/8"

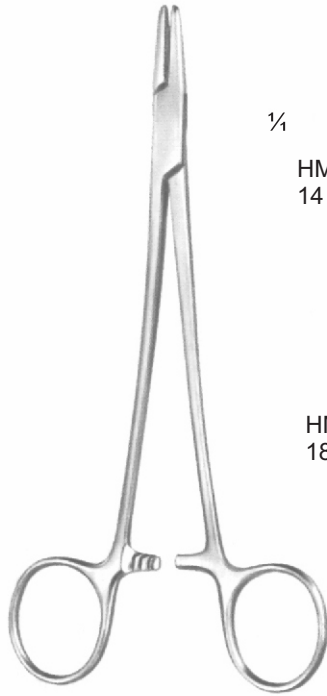


Crile-Murray
HM-68-2906
15 cm/5 7/8"
slender pattern



Adson

HM-68-2907
18 cm/7 1/8"
one fenestrated jaw



MAYO-HEGAR

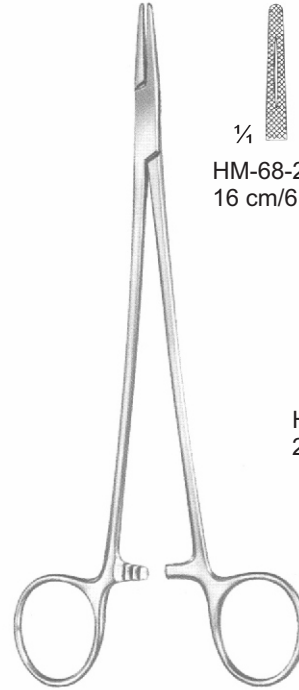
1/4

HM-68-2908
14 cm/5 1/2"

HM-68-2909
16 cm/6 1/4"

HM-68-2910
18.5 cm/7 1/4"

HM-68-2911
20.5 cm/8 1/8"



MAYO-HEGAR
slender pattern

1/4

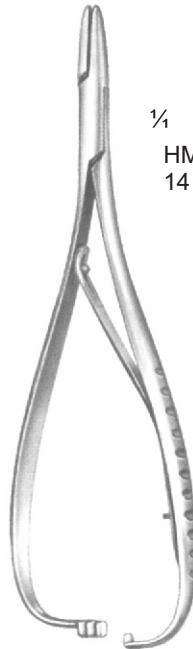
HM-68-2912 HM-68-2913
16 cm/6 1/4" 19 cm/7 1/2"

1/4

HM-68-2914
20.5 cm/8 1/8"



HEGAR-BAUMGARTNER
HM-68-2915
14 cm/5 1/2"



MATHIEU

1/4

HM-68-2916
14 cm/5 1/2"

HM-68-2917
17 cm/6 3/4"

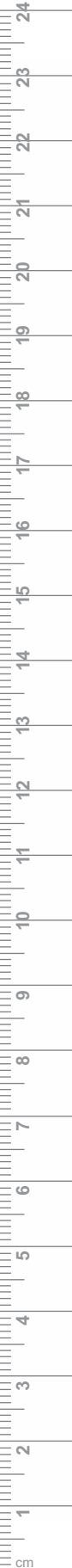
HM-68-2918
20 cm/7 7/8"

1/4

HM-68-2919 HM-68-2920
14 cm/5 1/2" 17 cm/6 3/4"



MATHIEU
slender pattern





- EN —● Needle Holders
- DE —● Nadelhalter
- ES —● Porta agujas
- FR —● Porte-aiguilles
- IT —● Porta-aghi



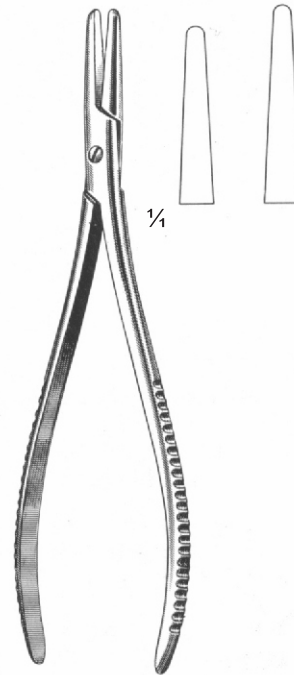
Lichtenberg
HM-68-2921
20 cm/7 7/8"



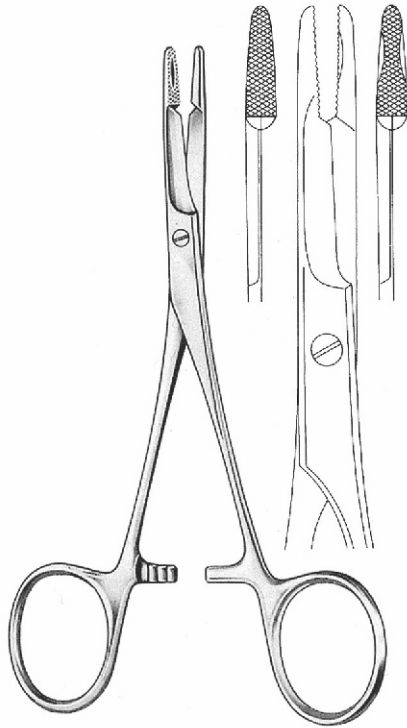
Toennis
HM-68-2922
18.5 cm/7 1/4"



Crile
HM-68-2923
15 cm/5 7/8"

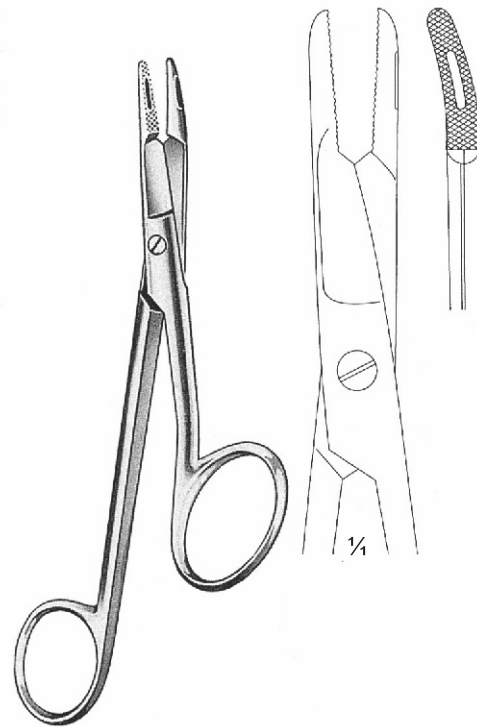


Langenbeck
HM-68-2924 16 cm/6 1/4"
HM-68-2925 20 cm/7 7/8"



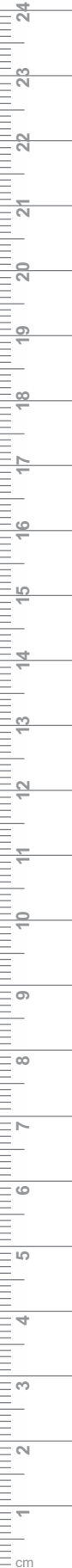
Olsen-Hegar

- HM-68-2926 11 cm/4 3/8"
- HM-68-2927 14 cm/5 1/2"
- HM-68-2928 18 cm/7 1/8"
- HM-68-2929 19 cm/7 1/2"



Gillies

- HM-68-2930 Right hand
- HM-68-2931 Left hand
- 16 cm/6 1/4"





- EN — Needle Holders
- DE — Nadelhalter
- ES — Porta agujas
- FR — Porte-aiguilles
- IT — Porta-aghi

MOMAD DENTAL SUPPLIES



HALSEY

1/4
 HM-68-2932
 13 cm/5 1/8"
 smooth jaw

HM-68-2933
 13 cm/5 1/8"
 0.4 mm



WEBSTER
 12.5 cm/4 7/8"

1/4
 HM-68-2934
 smooth jaw

HM-68-2935
 0.4 mm



DERF
 HM-68-2936
 12 cm/4 3/4"

1/4
 0.4 mm



Toennis
 HM-68-2937
 18 cm/7 1/8"

0.5 mm

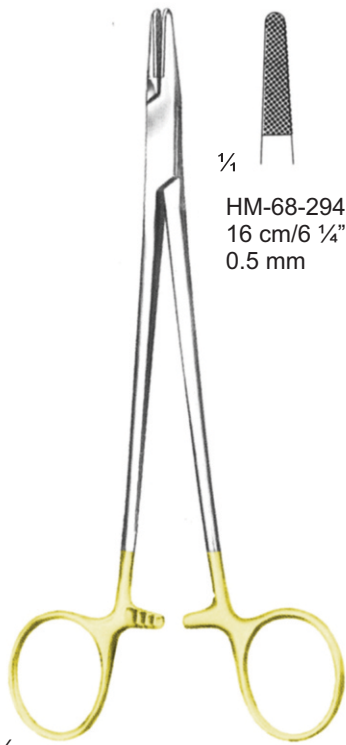


Langenbeck

0.5 mm
 HM-68-2938
 18.5 cm/7 1/4"

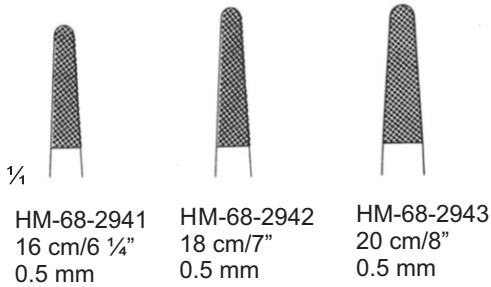
0.5 mm
 HM-68-2939
 20.5 cm/8 1/8"

0.5 mm
 HM-68-2940
 23 cm/9"

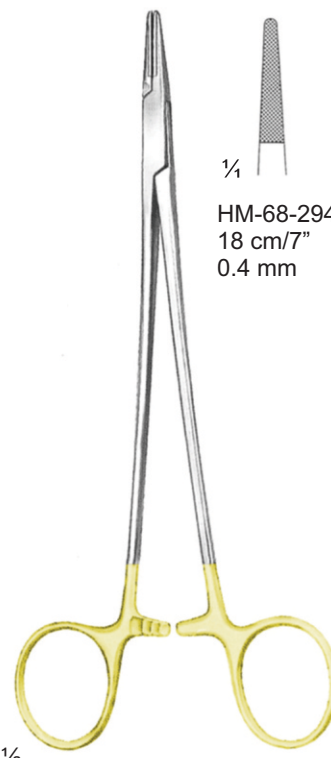


1/2

Mayo-Hegar
standard profile

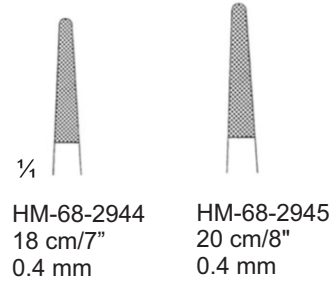


HM-68-2941 16 cm/6 1/4" 0.5 mm
 HM-68-2942 18 cm/7" 0.5 mm
 HM-68-2943 20 cm/8" 0.5 mm



1/2

Debaquey
mini profile

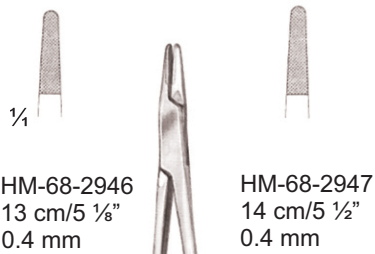


HM-68-2944 18 cm/7" 0.4 mm
 HM-68-2945 20 cm/8" 0.4 mm



1/2

HEGAR-BAUMGARTNER

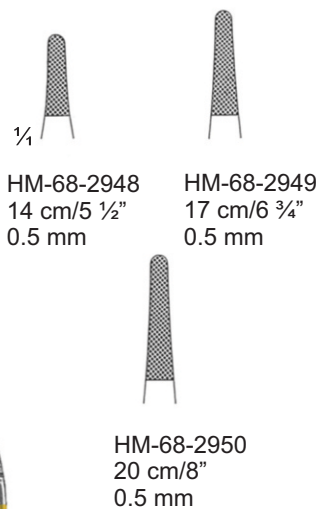


HM-68-2946 13 cm/5 1/8" 0.4 mm
 HM-68-2947 14 cm/5 1/2" 0.4 mm



1/2

Mathieu
Standard Profile

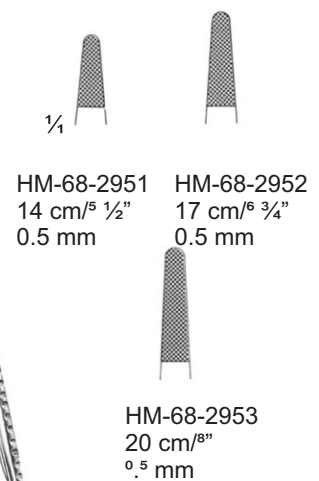


HM-68-2948 14 cm/5 1/2" 0.5 mm
 HM-68-2949 17 cm/6 3/4" 0.5 mm
 HM-68-2950 20 cm/8" 0.5 mm



1/2

Mathieu
Standard Profile

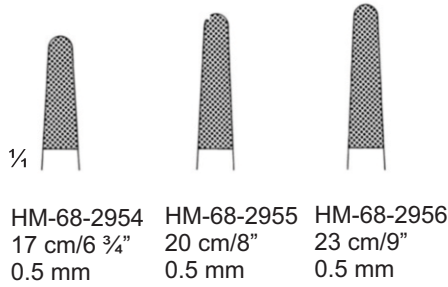


HM-68-2951 14 cm/5 1/2" 0.5 mm
 HM-68-2952 17 cm/6 3/4" 0.5 mm
 HM-68-2953 20 cm/8" 0.5 mm



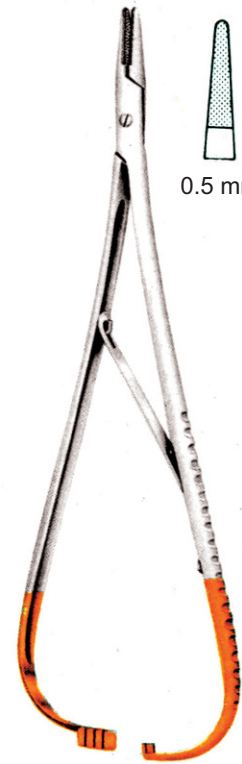


Mathieu



HM-68-2954 17 cm/6 3/4" 0.5 mm
 HM-68-2955 20 cm/8" 0.5 mm
 HM-68-2956 23 cm/9" 0.5 mm

with interior ratchet
 standard profile

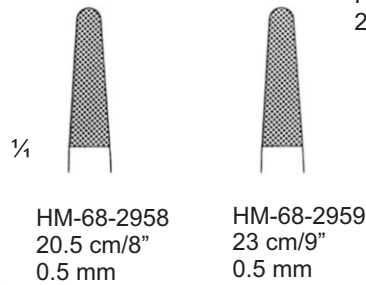


Lichtenberg
 HM-68-2957
 20 cm/7 7/8"

0.5 mm

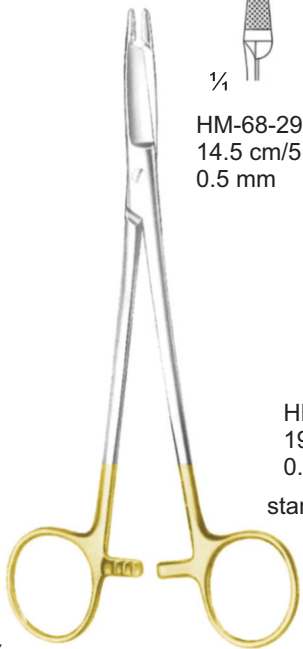


Zweifel



HM-68-2958 20.5 cm/8" 0.5 mm
 HM-68-2959 23 cm/9" 0.5 mm

with hinged rehet
 Standard Profile

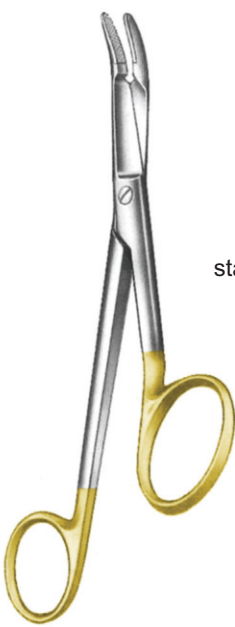
1/2

HM-68-2960
14.5 cm/5 3/4"
0.5 mm

HM-68-2961
17 cm/6 3/4"
0.5 mm

HM-68-2962
19 cm/9 1/2"
0.5 mm
standard profile

Olsen-Hegar



1/4

HM-68-2963
16 cm/6 1/4"
0.5 mm
standard profile

Gillies



1/4

HM-68-2964
11 cm/4 1/4"
smooth jaw

Foster-Gillies



1/4

HM-68-2965
15 cm/6"
0.4 mm
mini profile

Gillies-Mini



- EN — Needle Holders
- DE — Nadelhalter
- ES — Porta agujas
- FR — Porte-aiguilles
- IT — Porta-aghi

MOMAD DENTAL SUPPLIES




1/4

HM-68-2966
12 cm/4 3/4"
with lock

1/2

Castroviejo




1/4

HM-68-2967
12 cm/4 3/4"
with lock

1/2

Castroviejo



1/4

HM-68-2968
12.5 cm/5"
with lock, smooth jaw


1/2

Castroviejo




1/2

Castroviejo




1/4

HM-68-2969
14.5 cm/5 3/4"
with lock
micro profile
0.3 mm



HM-68-2970
14.5 cm/5 3/4"
with lock
micro profile
0.3 mm




HM-68-2971
14.5 cm/5 3/4"
smooth jaw
0.3 mm



HM-68-2972
18 cm/7"
with lock
micro profile
0.3 mm



HM-68-2973
21.5 cm/8 1/2"
with lock
micro profile
0.3 mm



1/4

HM-68-2974
14.5 cm/5 3/4"
smooth jaw



HM-68-2975
18 cm/7"
with lock
micro profile
0.3 mm



HM-68-2976
21.5 cm/8 1/2"
with lock
micro profile
0.3 mm

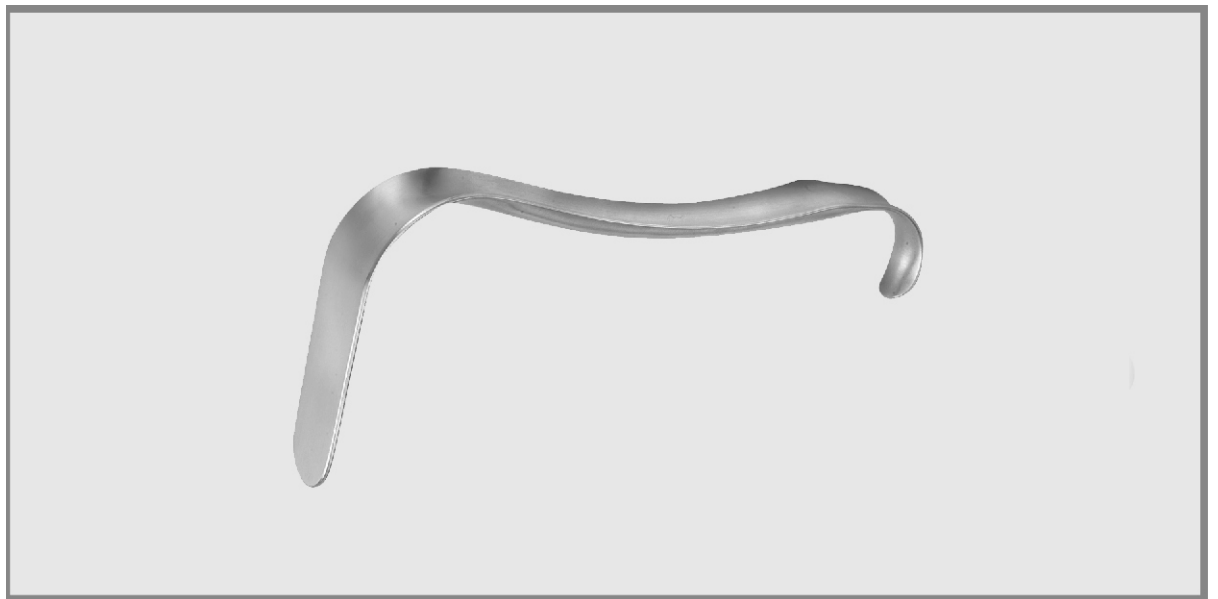


MOMAD DENTAL SUPPLIES

69

- EN** Retractors
- DE** Wundhaken
- ES** Ecarteurs
- FR** Separadores
- IT** Divaricatori

Page 144 to 148





- EN — Retractors
- DE — Wundhaken
- ES — Ecarteurs
- FR — Separadores
- IT — Divaricatori

MOMAD DENTAL SUPPLIES

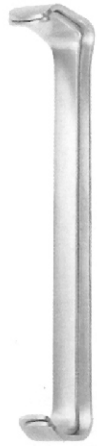


Fig. 2 = 30 x 10 mm
Fig. 1 = 26 x 10 mm

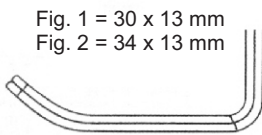
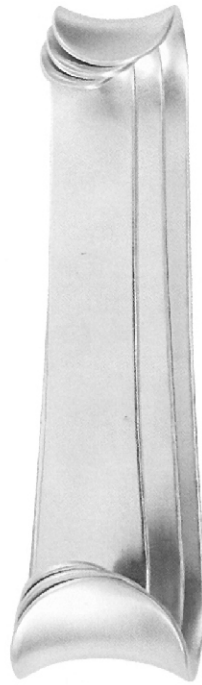


Fig. 1 = 30 x 13 mm
Fig. 2 = 34 x 13 mm

FARABEUF
HM-69-3001
12 cm/4 3/4"
Fig. 1 - 2



ROUX
HM-69-3002

Set complete, Fig. 1- 3

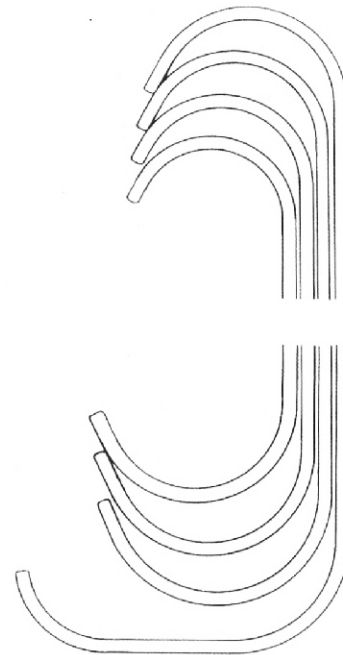
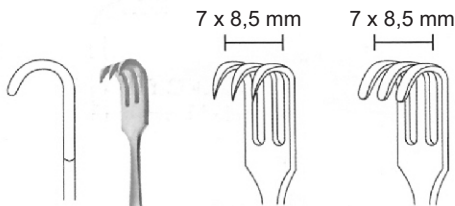


Fig. 1	14 cm/5 1/2"	HM-69-3003	24 x 20 / 30 x 28
Fig. 2	15 cm/6"	HM-69-3004	29 x 26 / 36 x 36
Fig. 3	17 cm/6 3/4"	HM-69-3005	23 x 29 / 38 x 43
Fig. 4	18 cm/7"	HM-69-3006	29 x 24 / 45 x 28



HM-69-3007 sharp
HM-69-3008 blunt



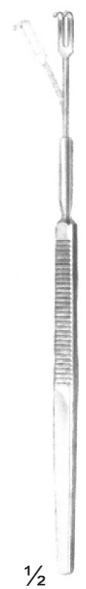
SENN
HM-69-3011
17 cm/6 3/4"

sharp



16 cm/6 1/4" HM-69-3010

sharp



16 cm/6 1/4" HM-69-3012



HM-69-3013



HM-69-3014



HM-69-3015

HM-69-3015
18 cm/7"
Fig. 1

small curvature

HM-69-3016
18 cm/7"
Fig. 2

large curvature



GILLIES
HM-69-3016
18 cm/7"

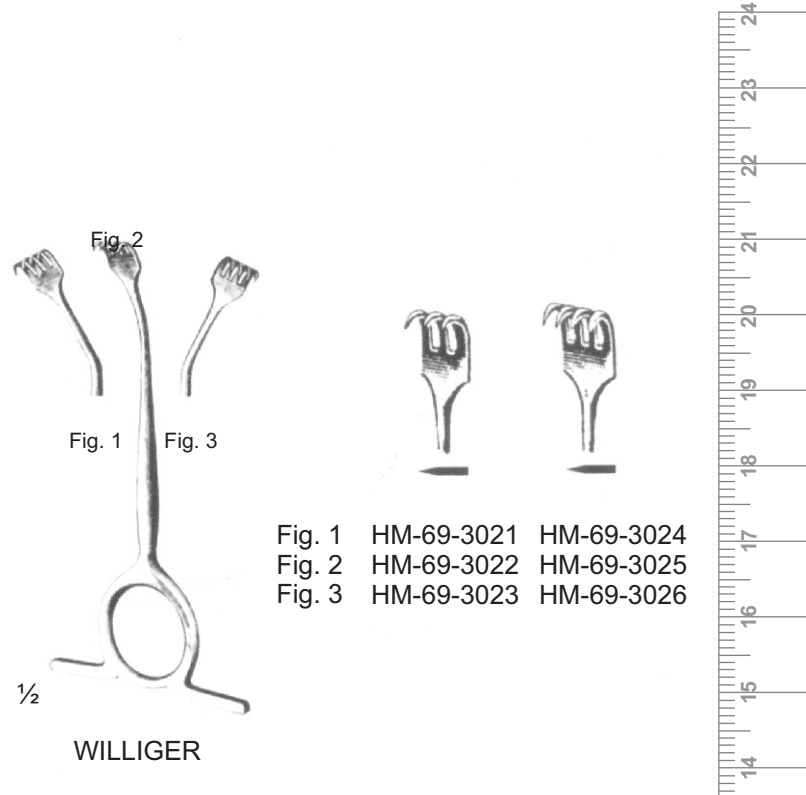
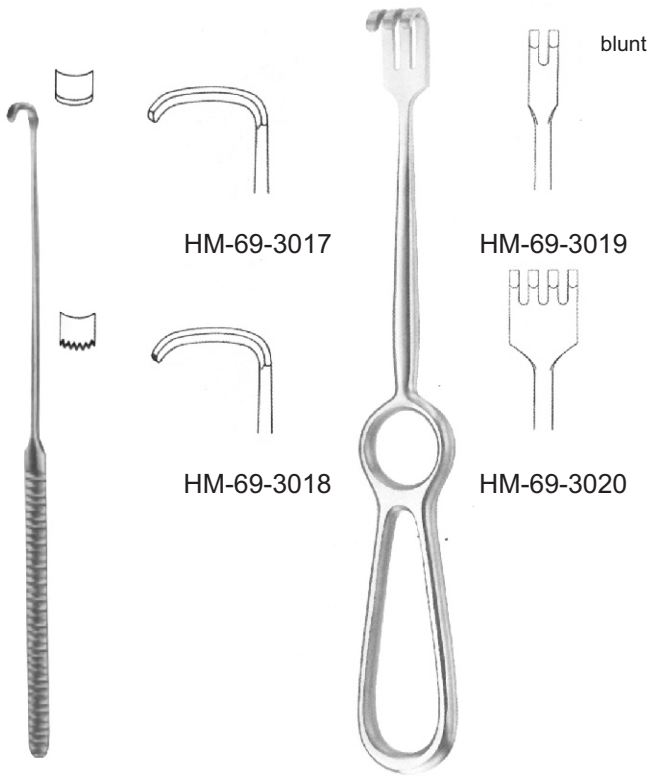
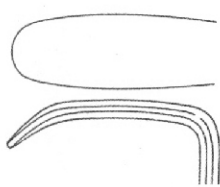


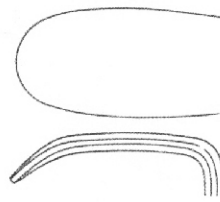
Fig. 1 HM-69-3021 HM-69-3024
 Fig. 2 HM-69-3022 HM-69-3025
 Fig. 3 HM-69-3023 HM-69-3026

STRANDELL-STILLE
 19, cm/7 1/2"

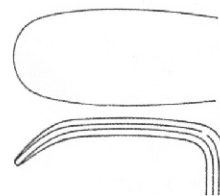
VOLKMANN
 21,5 cm/8 1/2"



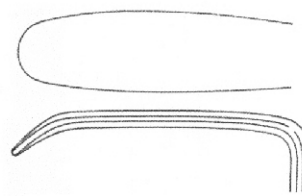
HM-69-3027
 30x 11 mm



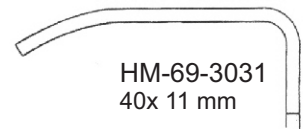
HM-69-3029
 30x 16 mm



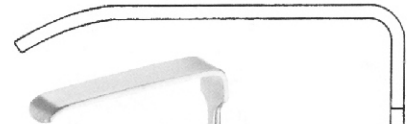
HM-69-3028
 30x 14 mm



HM-69-3030
 40x 11 mm



HM-69-3031
 40x 11 mm



HM-69-3032
 55x 11 mm

LANGENBECK
 22 cm/8 3/4"

KOCHER-LANGENBECK
 22 cm/8 1/2"

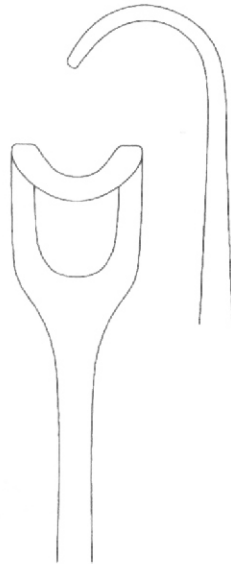


- EN ● Cheek retractors
- DE ● Wangenhalter
- ES ● Ecarteurs des joues
- FR ● Separatori per guancia
- IT ● Separadores para mejillas

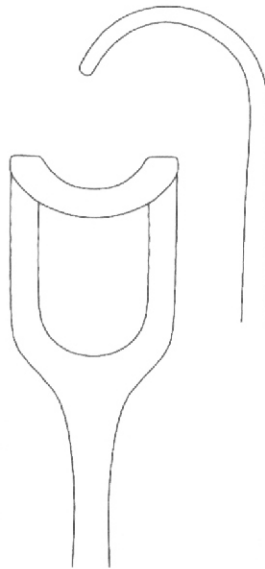
MOMAD DENTAL SUPPLIES



MIDDELDORPF



HM-69-3033
21,5 cm/8 1/2"
14 x 17 mm



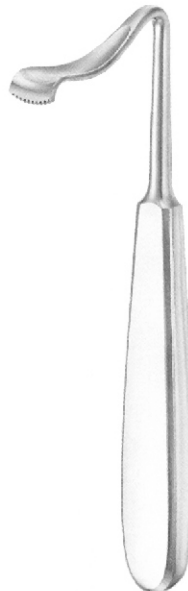
HM-69-3034
22 cm/8 3/4"
20 x 22 mm



KOCHER LANGENBECK
HM-69-3035
21 cm/8 1/4"
23 x 8 mm



WARD
HM-69-3036
15,5 cm/6"



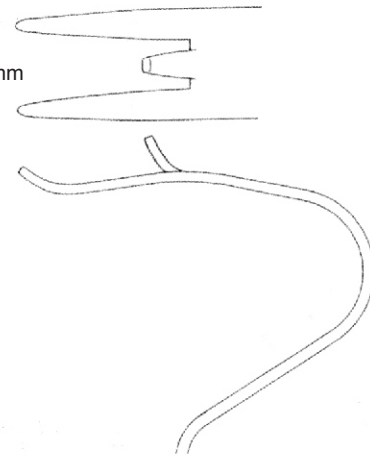
BOWDLER=HENRY
HM-69-3037
16 cm/6 1/4"



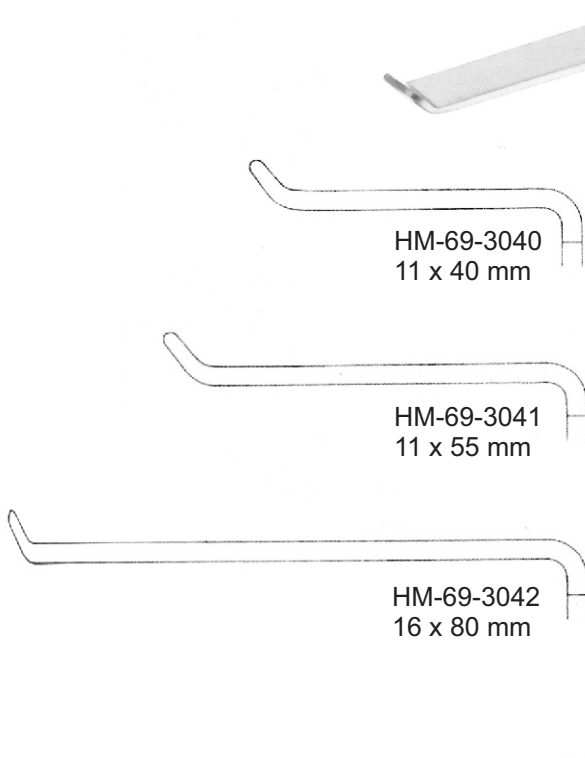
KAY (AUSTIN)
HM-69-3038



16,5 mm



OBWEGESER
 HM-69-3039
 16 cm/6 1/4"

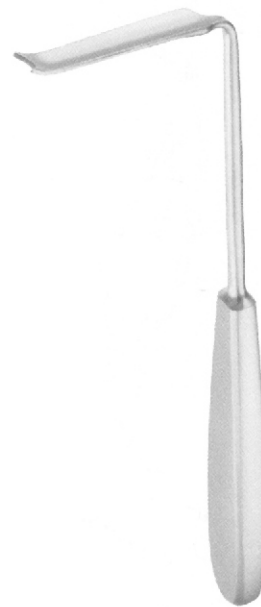


HM-69-3040
 11 x 40 mm

HM-69-3041
 11 x 55 mm

HM-69-3042
 16 x 80 mm

OBWEGESER
 21,5 cm/8 1/2"

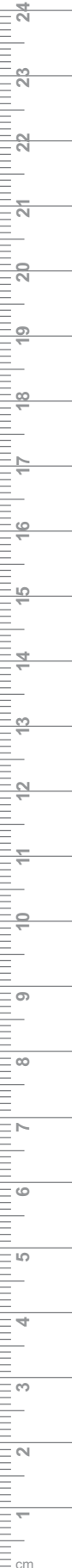


HM-69-3043
 30 x 9/12 mm

HM-69-3044
 45 x 9/12 mm

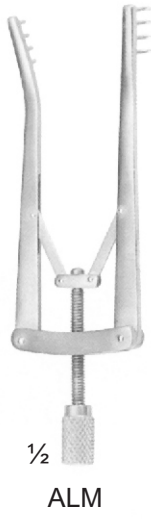
HM-69-3045
 60 x 9/12 mm

OBWEGESER

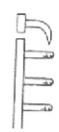




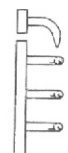
- EN ● Cheek retractors
- DE ● Wangenhalter
- ES ● Ecarteurs des joues
- FR ● Separatori per guancia
- IT ● Separadores para mejillas



1/2
ALM



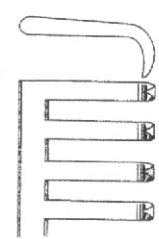
HM-69-3046
7 cm/2 3/4"
sharp



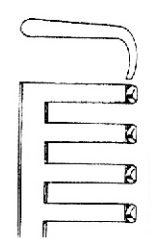
HM-69-3047
10 cm/4"
sharp



1/2
WEITLANER



HM-69-3048
13 cm/4 1/4"
3 : 4
sharp



HM-69-3049
13 cm/4 1/4"
3 : 4
blunt

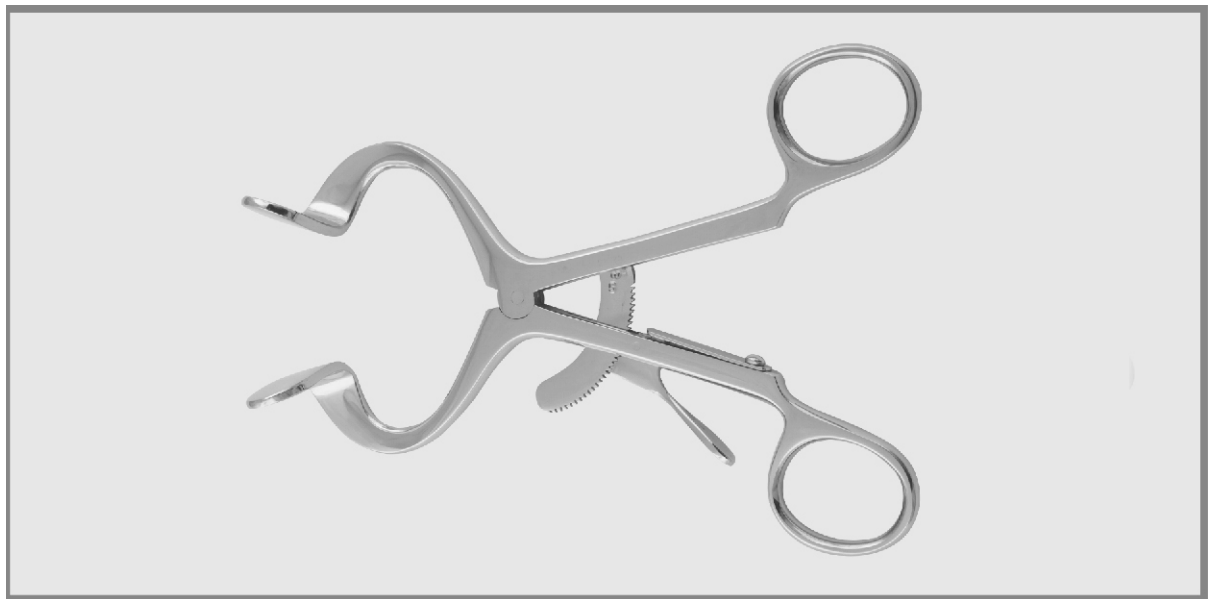


MOMAD DENTAL SUPPLIES

70

- EN** Mouth and Tongue
- DE** Mund und Zunge
- ES** Boca y la lengua
- FR** Bouche et langue
- IT** Bocca e la lingua

Page 149 to 152





- EN — Mouth gags
- DE — Mundsperrer
- ES — Ouvre-bouche
- FR — Abrebocas
- IT — Apribocca

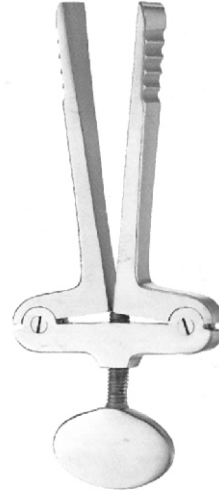
MOMAD DENTAL SUPPLIES



DOYEN-JANSEN (MOLT)
 HM-70-3100 9 cm/3 1/2"
 HM-70-3101 11 cm/4 1/2"
 HM-70-3102 14 cm/5 1/2"



DENHARDT
 HM-70-3103
 12 cm/5"



HEISTER
 HM-70-3104
 13 cm/5 1/4"



ROSIER-KOENIG
 16 cm/6 1/4" HM-70-3105
 19 cm/7 1/2" HM-70-3106



JENNINGS
 9 cm/3 1/2" HM-70-3107
 11 cm/4 1/2" HM-70-3108
 13 cm/5" HM-70-3109
 15 cm/6" HM-70-3110

24 x 27 mm

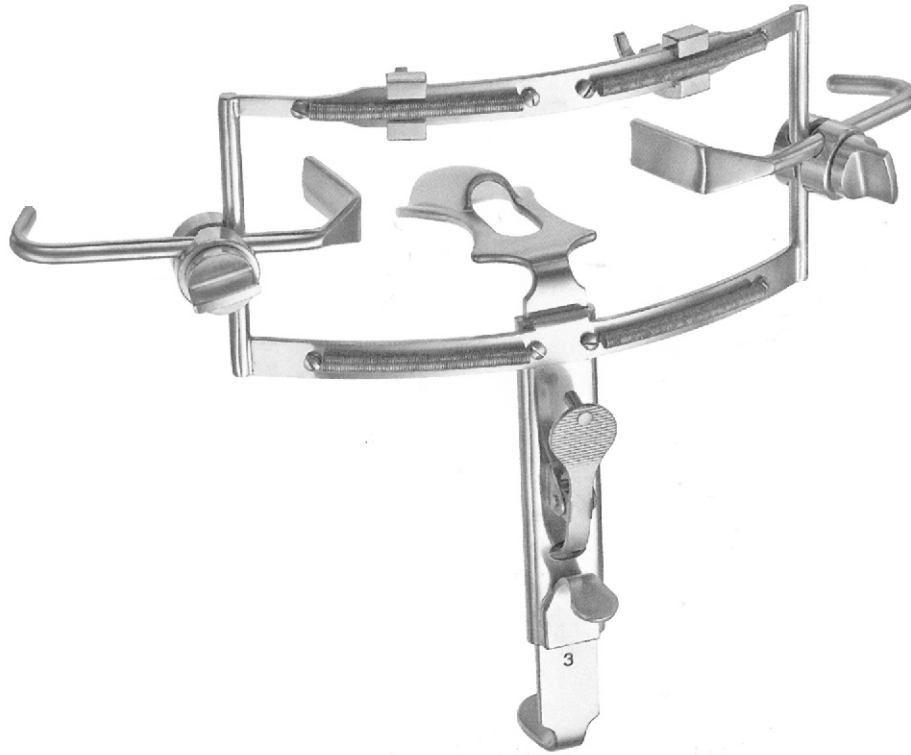


COLLIN
 HM-70-3111
 16 cm/6 1/2"



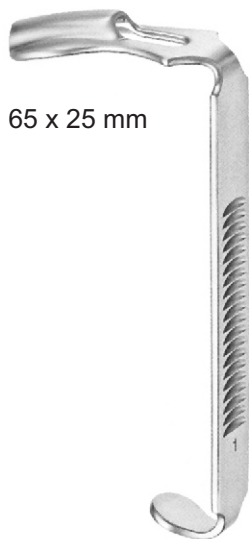
YOUNG
 HM-70-3112
 16 cm/6 1/2"

HM-70-3113



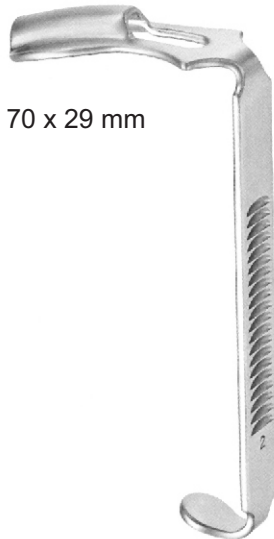
complete with frame,
 3 tongue depressors,
 2 tooth plates

DINGMANN
 HM-70-3114
 14,5 cm/5 3/4"



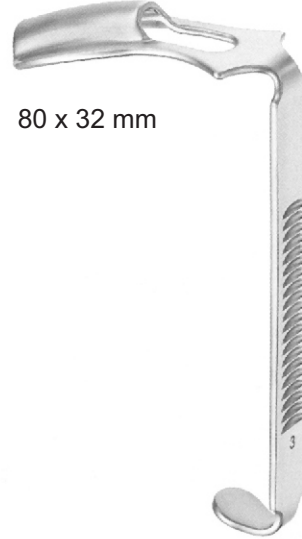
65 x 25 mm

HM-70-3115
 13,5 cm/5 1/4"



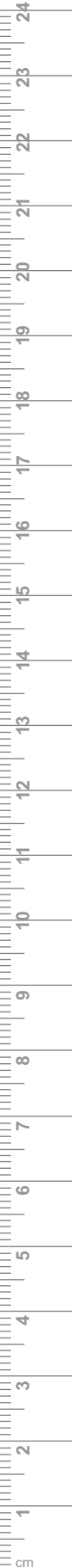
70 x 29 mm

HM-70-3116
 13,5 cm/5 1/4"



80 x 32 mm

HM-70-3117
 13,5 cm/5 1/4"

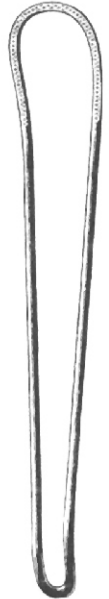




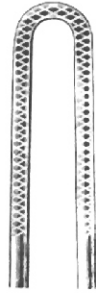
- EN —●— Tongue Depressors
- DE —●— Zungenspateln
- ES —●— Abaisse-langue
- FR —●— Abajalengua
- IT —●— Abbassalingua



HM-70-3118
16 cm/6 1/4"



FRENZEL
HM-70-3119
16,5 cm/6 1/2"



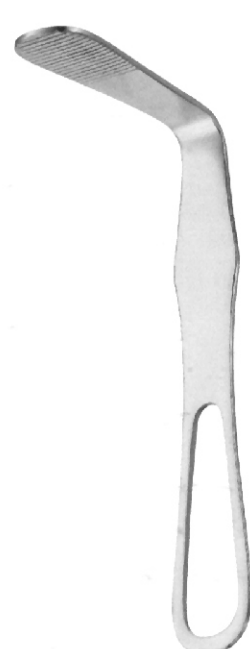
19 / 15 mm



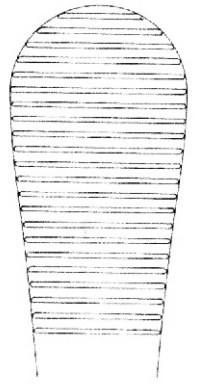
BRUENINGS
HM-70-3120
19 cm/7 1/2"



BUCHWALD
HM-70-3121
19 cm/7 1/2"



HARTMANN
HM-70-3122
15 cm/6"

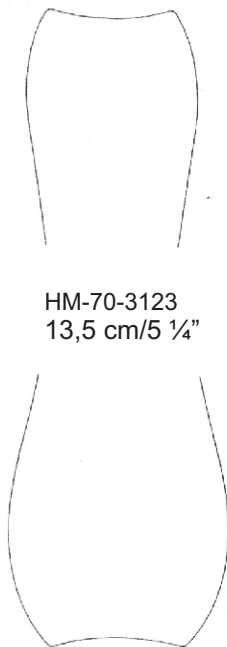


72 X 23 mm



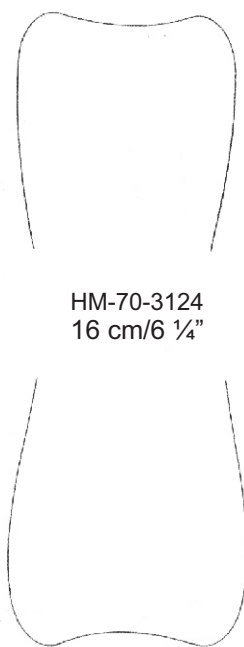
24 / 30 mm

HM-70-3123
13,5 cm/5 1/4"

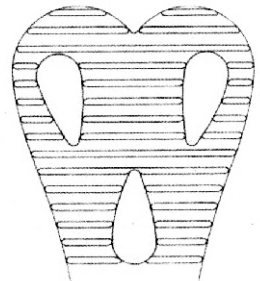


30 / 34 mm

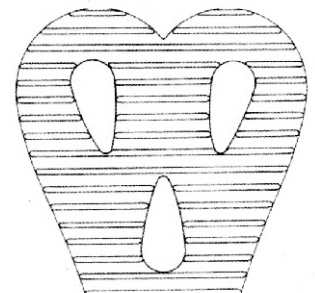
HM-70-3124
16 cm/6 1/4"



WIEDER



HM-70-3125
14 cm/5 1/2"
36 mm

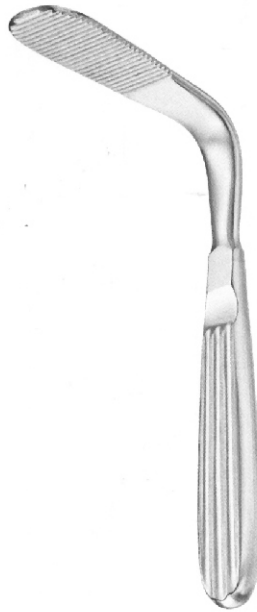


HM-70-3126
15 cm/6"
43 mm



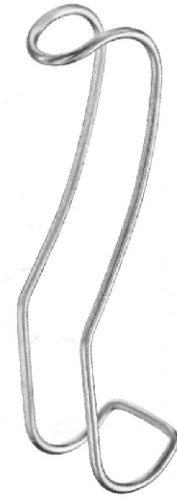
85 x 24 mm

TOBOLD
 HM-70-3127
 14,5 cm/5 ¾"



88 x 25 mm

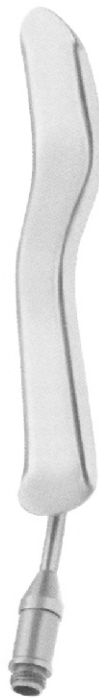
TOBOLD
 HM-70-3128
 15 cm/6"



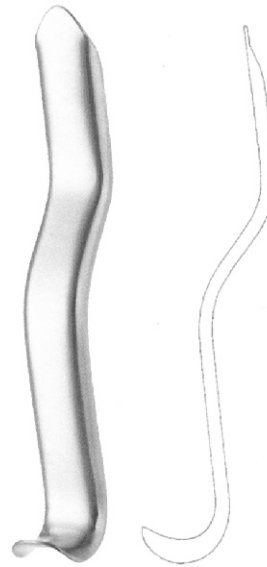
STERNBERG
 HM-70-3129
 14 cm/5 ½"



SIMPLEX
 HM-70-3130
 11 cm/4 ¼"



CAWOOD-MINNESOTA
 HM-70-3131
 14 cm/5 ½"



CAWOOD-MINNESOTA
 HM-70-3132
 15 cm/6"
 20 mm



CAWOOD-MINNESOTA
 HM-70-3133
 19 cm/7 ½"



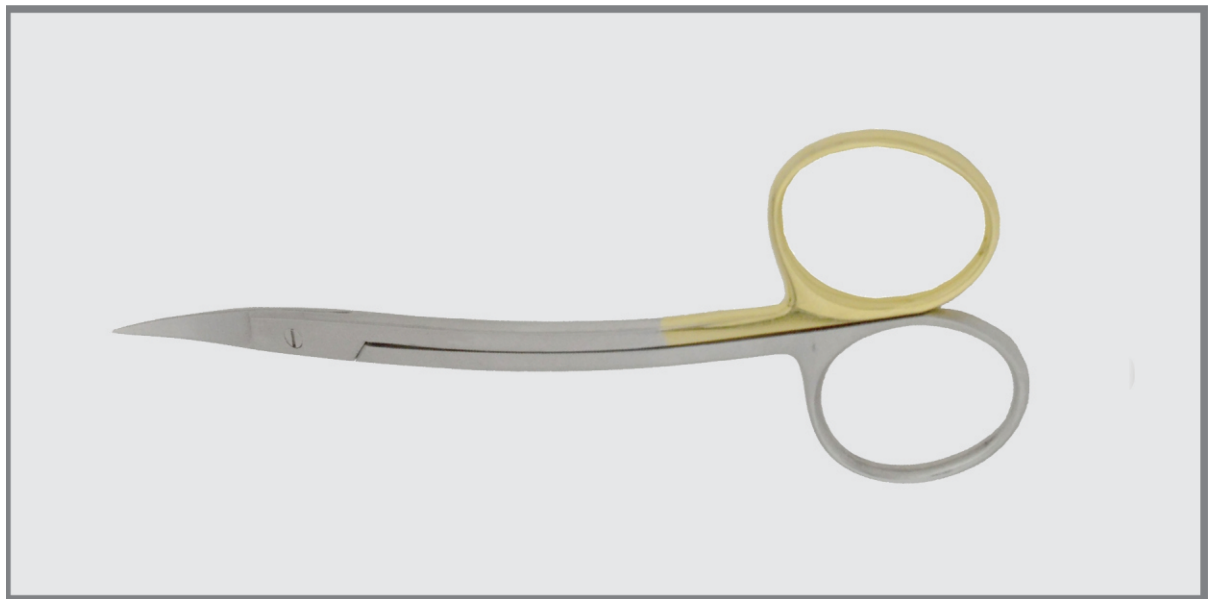


MOMAD DENTAL SUPPLIES

71

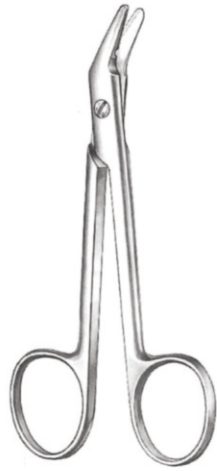
EN	Scissors
DE	Schere
ES	Tijeras
FR	Les ciseaux
IT	Forbici

Page 153 to 171

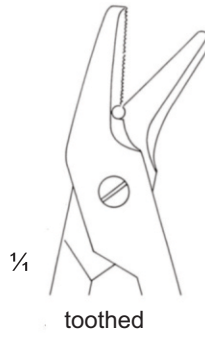




- EN —●— Wire Cutting Scissors
- DE —●— Drahtscheren
- ES —●— Tijeras para alambre
- FR —●— Ciseaux de coupe de fil
- IT —●— Forbici da taglio a filo



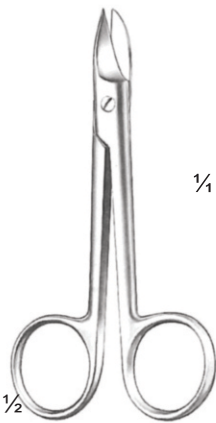
HM-71-3200
universal
12 cm/4 3/4"



1/4
toothed



HM-71-3201 TC
universal
12 cm/4 3/4"



Beebee
10.5 cm/4 1/8"

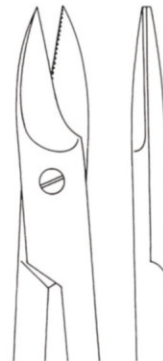


1/4

HM-71-3202
B-002-10 TC



HM-71-3203
B-003-10 TC



HM-71-3204
B-004-10 TC



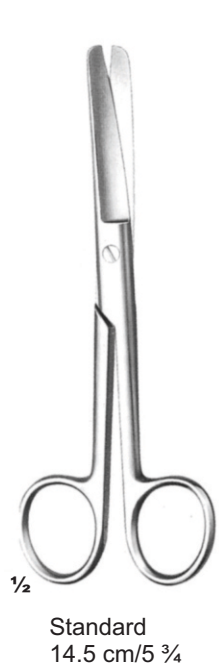
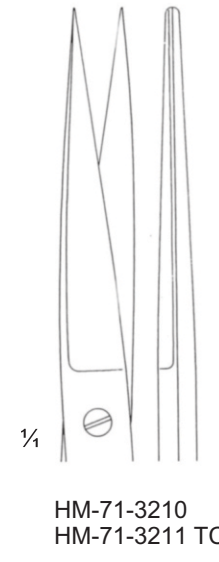
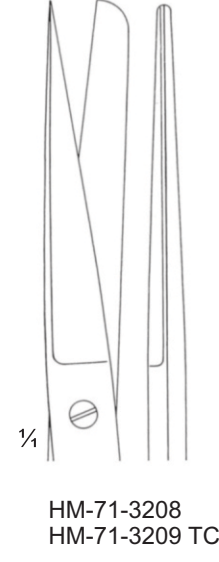
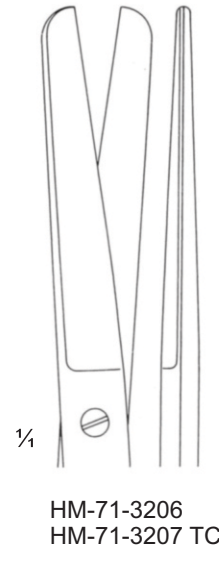
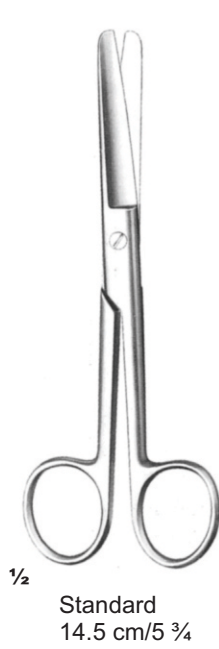
HM-71-3205
B-005-10 TC

one toothed cutting edge



Beebee
10.5 cm/4 1/8"







- EN — Operating scissors
- DE — Chirurgische scheren
- ES — Tijeras quirúrgicas
- FR — Ciseaux de fonctionnement
- IT — Forbici funzionanti

MOMAD DENTAL SUPPLIES



DELICATE

1/2
14.5 cm/5 3/4"

1/4
HM-71-3218
HM-71-3219 TC

1/4
HM-71-3220
HM-71-3221 TC

1/4
HM-71-3222
HM-71-3223 TC

1/2
14.5 cm/5 3/4"

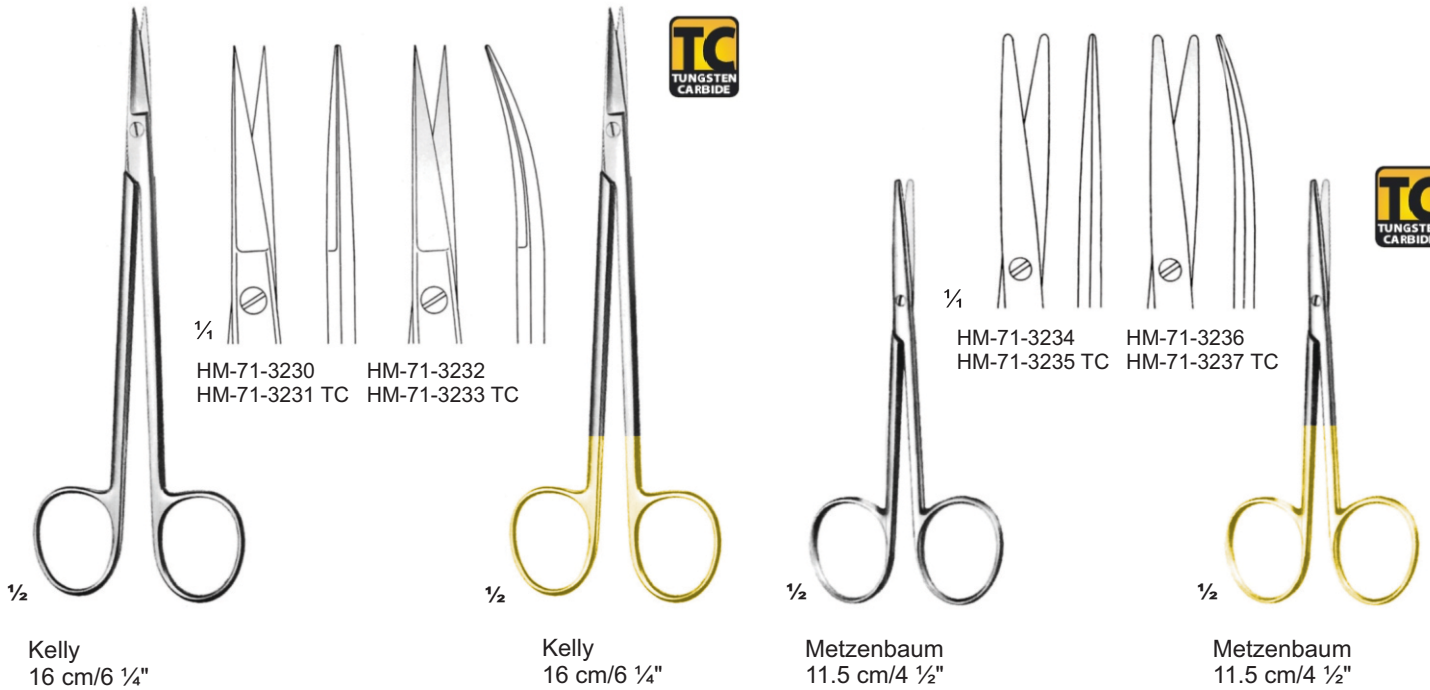
1/2
14.5 cm/5 3/4"

1/4
HM-71-3224
HM-71-3225 TC

1/4
HM-71-3226
HM-71-3227 TC

1/4
HM-71-3228
HM-71-3229 TC

1/2
14.5 cm/5 3/4"



Kelly
16 cm/6 1/4"

Kelly
16 cm/6 1/4"

Metzenbaum
11.5 cm/4 1/2"

Metzenbaum
11.5 cm/4 1/2"



Metzenbaum
14 cm/5 1/2"

Metzenbaum
14 cm/5 1/2"

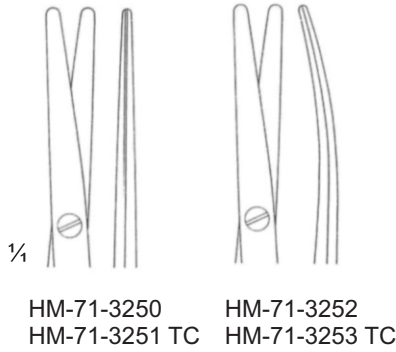




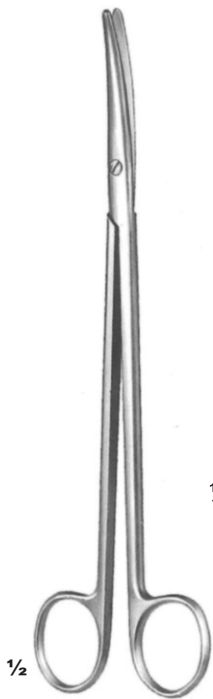
DELICATE



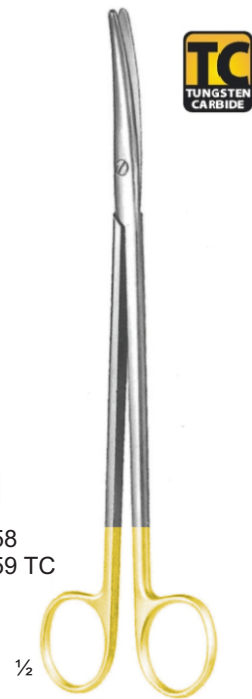
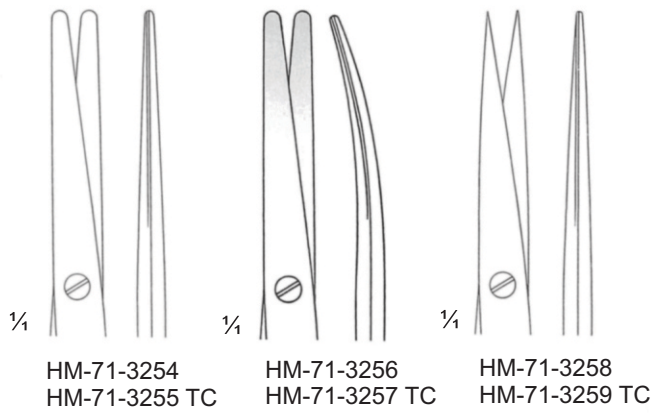
Metzenbaum
15.5 cm/6"



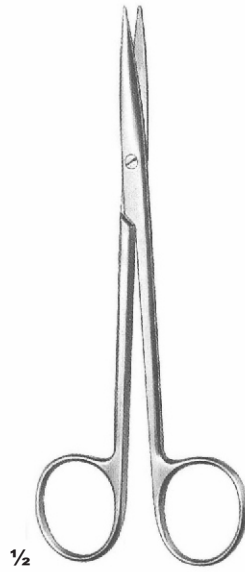
Metzenbaum
15.5 cm/6"



Metzenbaum-Nelson
18 cm/7"

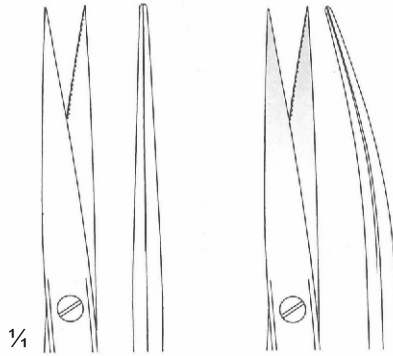


Metzenbaum-Nelson
18 cm/7"



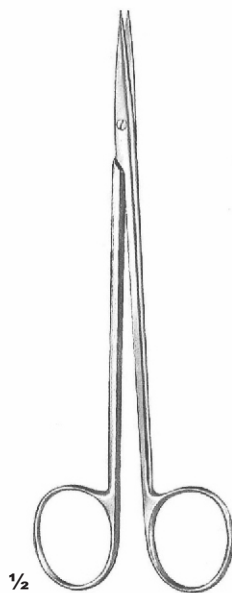
1/2

Metzenbaum
 14.5 cm/5 3/4"



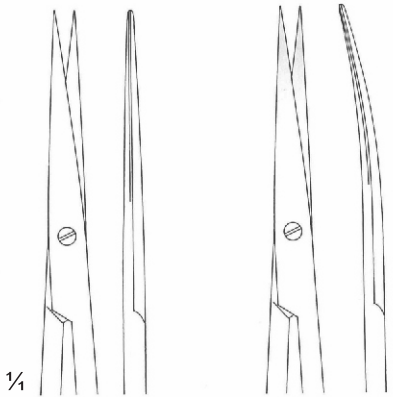
1/4

HM-71-3260



1/2

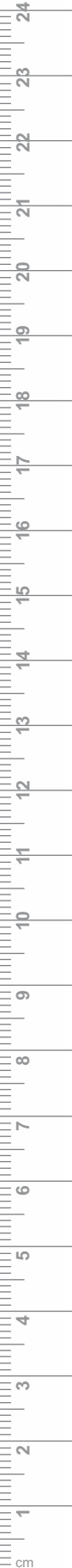
Nerve dissecting scissors
 15.5 cm/6"



1/4

HM-71-3262

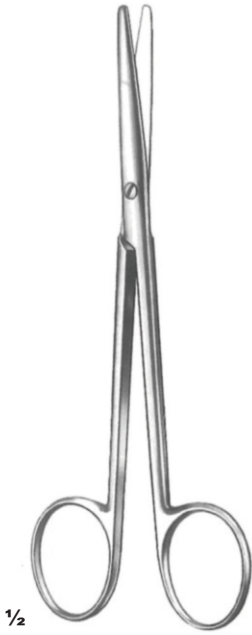
HM-71-3263



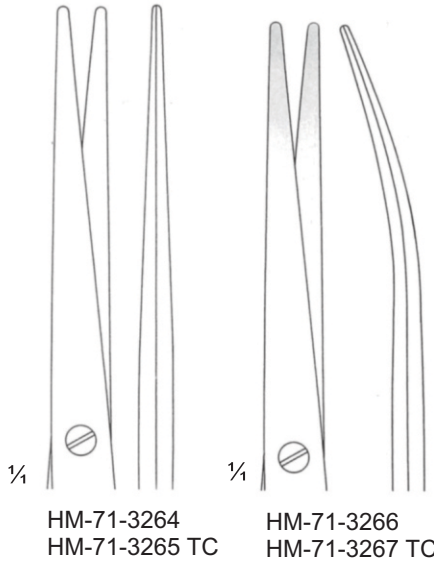


- EN — Dissecting scissors
- DE — Präparierscheren
- ES — Tijeras de disección
- FR — Ciseaux à dissection
- IT — Forbici da dissezione

MOMAD DENTAL SUPPLIES



Lexer-Fino
slender pattern
16.5 cm/6 1/2"

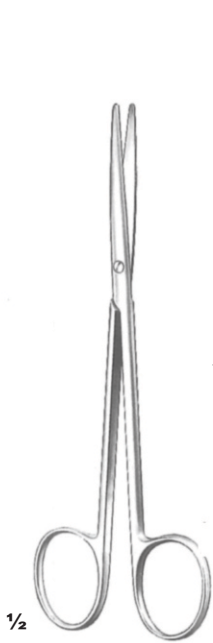


HM-71-3264
HM-71-3265 TC

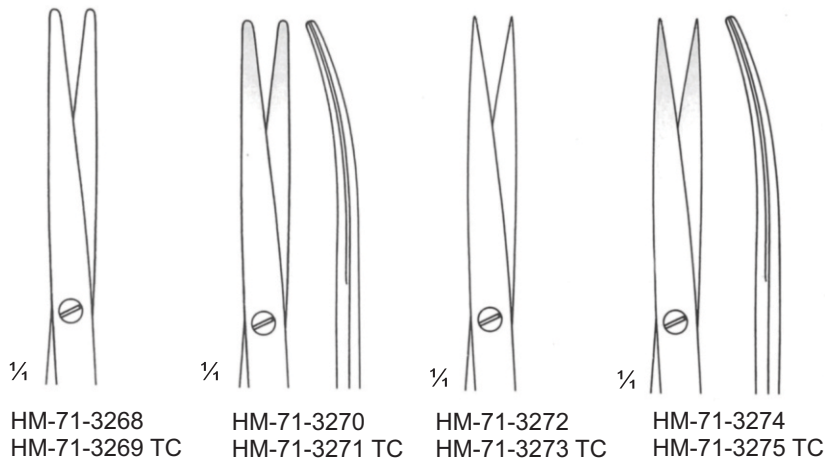
HM-71-3266
HM-71-3267 TC



Lexer-Fino
slender pattern
16.5 cm/6 1/2"



Metzenbaum-Fino
slender pattern
14.5 cm/5 3/4"



HM-71-3268
HM-71-3269 TC

HM-71-3270
HM-71-3271 TC

HM-71-3272
HM-71-3273 TC

HM-71-3274
HM-71-3275 TC



Metzenbaum-Fino
slender pattern
14.5 cm/5 3/4"



Metzenbaum-Fino
slender pattern
18 cm/7"



HM-71-3276
HM-71-3277 TC



HM-71-3278
HM-71-3279 TC



Metzenbaum-Fino
slender pattern
18 cm/7"



Metzenbaum-Fino
S shaped
18 cm/7"



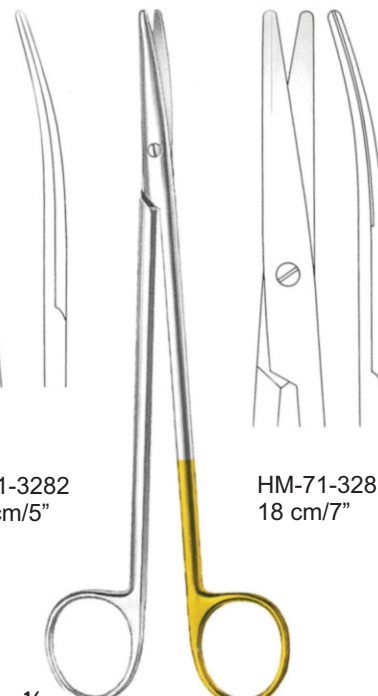
HM-71-3280
HM-71-3281 TC



Metzenbaum-Fino
S shaped
18 cm/7"



HM-71-3282
12.5 cm/5"



Salyer
fine model for cleft palate





- EN —●— Gum scissors, dissecting scissors, operating scissors
- DE —●— Zahnfleissscheren, präparierscheren, chirurgische scheren
- ES —●— Tijeras para encías, Tijeras de disección, Tijeras quirúrgicas
- FR —●— Ciseaux de gomme, ciseaux de dissection, ciseaux de fonctionnement
- IT —●— Forbici da masticare, forbici da dissezione, forbici funzionanti

MOMAD DENTAL SUPPLIES



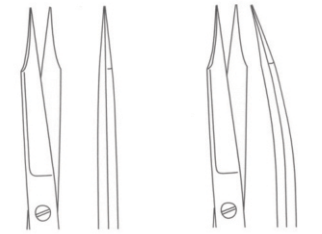
 <p>1/2</p> <p>Sanvenero 14 cm/5 1/8"</p>	 <p>1/2</p> <p>Sanvenero 14 cm/5 1/8"</p>	 <p>1/2</p> <p>Joseph 14.5 cm/5 3/4"</p>	 <p>1/2</p> <p>Joseph 14.5 cm/5 3/4"</p>
 <p>1/2</p> <p>Diethrich-Salyer HM-71-3292 12 cm/4 3/4"</p>	 <p>1/4</p> <p>HM-71-3293 angled upwards</p>	 <p>1/2</p> <p>Dean 17.5 cm/7"</p>	 <p>1/4</p> <p>HM-71-3294 toothed, angled upwards</p>

Gum scissors, operating scissors
 Zahnfleischscheren, chirurgische scheren
 Tijeras para encías, Tijeras quirúrgicas
 Ciseaux de gomme, ciseaux de fonctionnement
 Forbici da masticare, forbici funzionanti

- EN
- DE
- ES
- FR
- IT

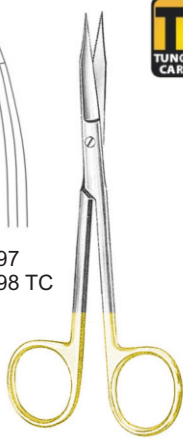


GOLDMANN-FOX
13 cm/5 1/8"

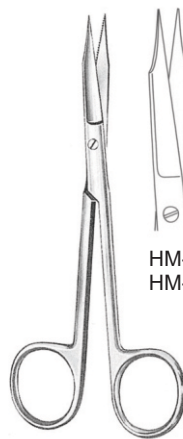


HM-71-3295
HM-71-3296 TC

HM-71-3297
HM-71-3298 TC



GOLDMANN-FOX
13 cm/5 1/8"



GOLDMANN-FOX
13 cm/5 1/8"



HM-71-3299
HM-71-3300 TC

Toothed Blades



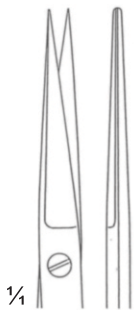
HM-71-3301
HM-71-3302 TC



GOLDMANN-FOX
13 cm/5 1/8"



Small model
12 cm/4 3/4"



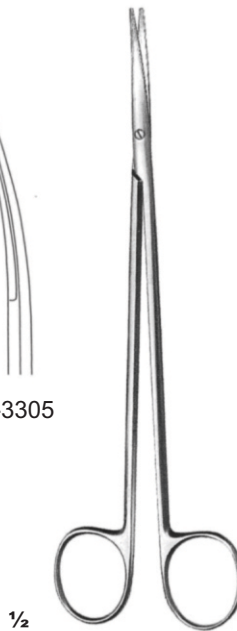
HM-71-3303



HM-71-3304



HM-71-3305



Toennis-Adson
17.5 cm/7"



slender pattern
HM-71-3306
HM-71-3307 TC



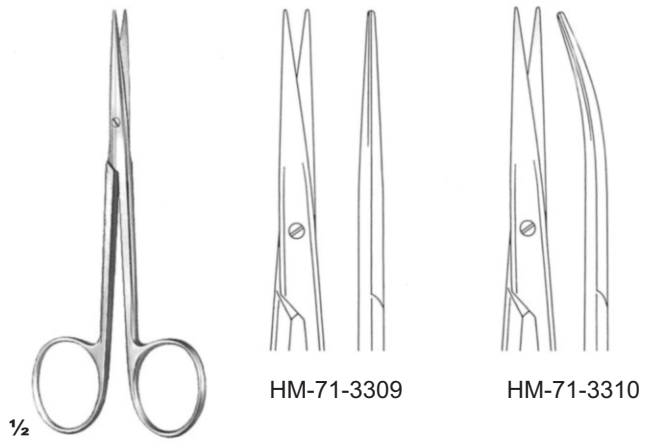
Toennis-Adson
17.5 cm/7"



- EN —●— Gum scissors, operating scissors
- DE —●— Zahnfleischscheren, chirurgische scheren
- ES —●— Tijeras para encías, Tijeras quirúrgicas
- FR —●— Ciseaux de gomme, ciseaux de fonctionnement
- IT —●— Forbici da masticare, forbici funzionanti



1/2 La Grange
11.5 cm/4 1/2"



1/2 Delicate
11.5 cm/4 1/2"



1/2 Locklin
16 cm/6 1/4"

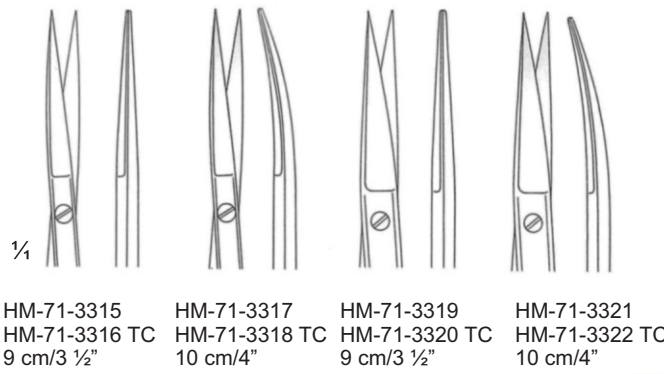
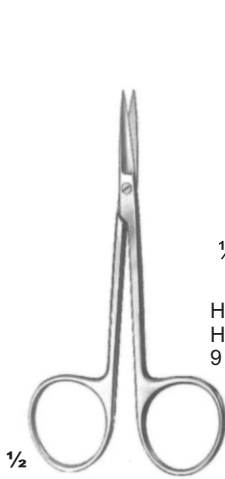


1/2 Locklin
16 cm/6 1/4"



one toothed cutting edge

one toothed cutting edge

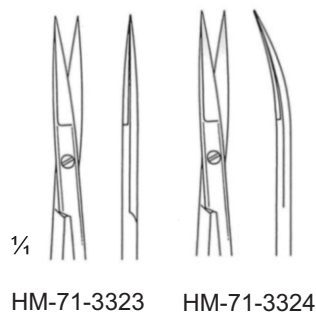
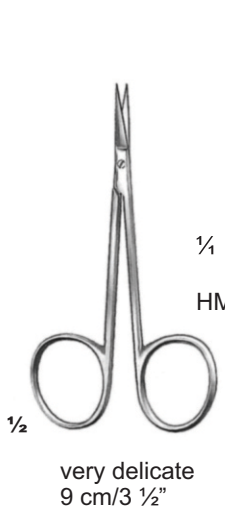


HM-71-3315
 HM-71-3316 TC
 9 cm/3 1/2"

HM-71-3317
 HM-71-3318 TC
 10 cm/4"

HM-71-3319
 HM-71-3320 TC
 9 cm/3 1/2"

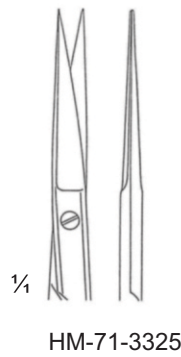
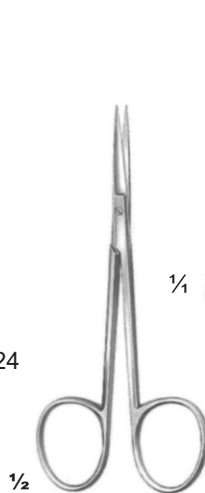
HM-71-3321
 HM-71-3322 TC
 10 cm/4"



HM-71-3323

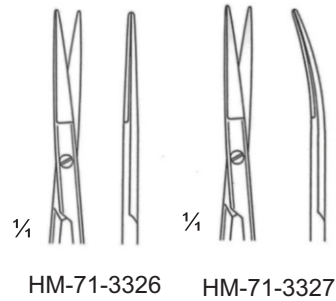
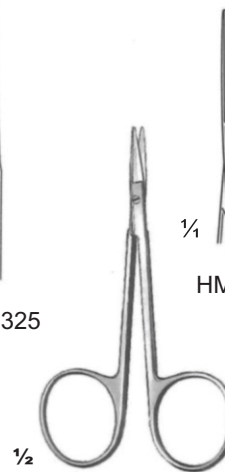
HM-71-3324

very delicate
 9 cm/3 1/2"



HM-71-3325

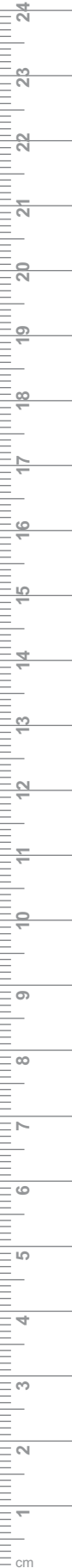
extra flat blades
 10 cm/4"



HM-71-3326

HM-71-3327

Bonn
 9 cm/3 1/2"





- EN — Iris Scissors, tendon scissors
- DE — Irisscheren, Sehenscheren
- ES — Tijeras para iridectomia, tijeras para tendones
- FR — Ciseaux d'iris, ciseaux de tendon
- IT — Iris Scissors, forbici tendine

MOMAD DENTAL SUPPLIES



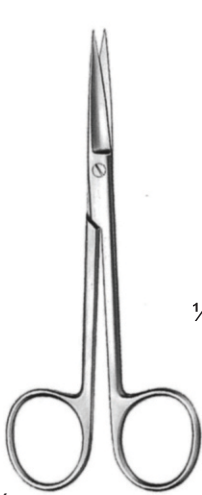
11.5 cm/4 1/2"



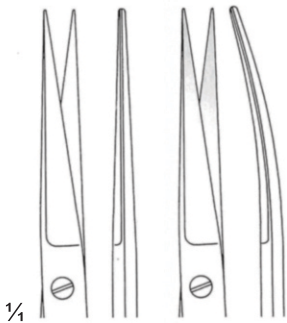
HM-71-3328 HM-71-3330 HM-71-3332 HM-71-3334
 HM-71-3329 TC HM-71-3331 TC HM-71-3333 TC HM-71-3335 TC



11.5 cm/4 1/2"



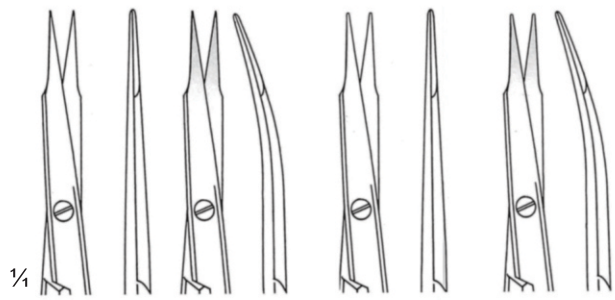
12.5 cm/5"



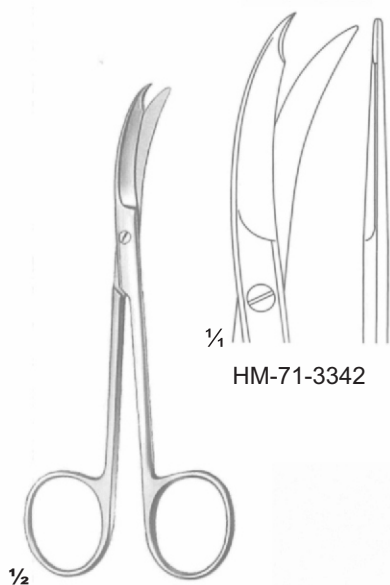
HM-71-3336 HM-71-3337



Stevens
 11 cm/4 1/2"



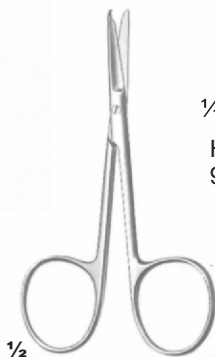
HM-71-3338 sharp HM-71-3339 sharp HM-71-3340 blunt HM-71-3341 blunt



1/2
 Northbent
 13 cm/5"



1/4
 HM-71-3342



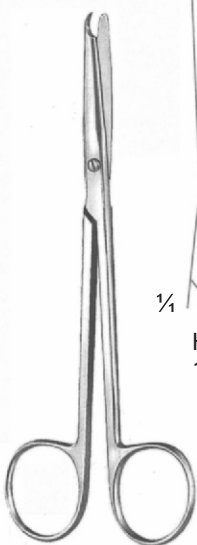
1/2
 Spencer



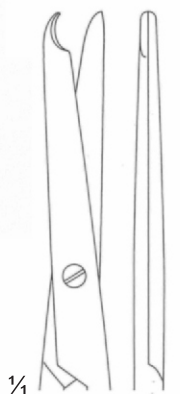
1/4
 HM-71-3343
 9 cm/3 1/2"



1/4
 HM-71-3344
 13 cm/5"



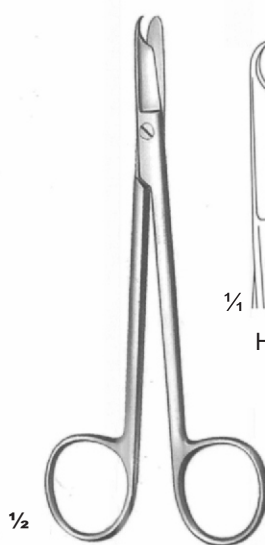
1/2
 Buck



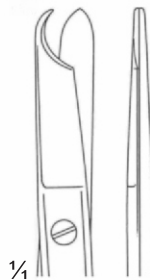
1/4
 HM-71-3345
 14.5 cm/5 3/4"



1/4
 HM-71-3346
 18 cm/7"



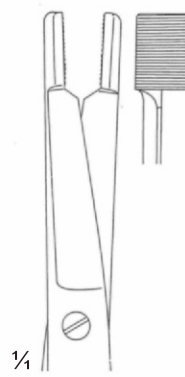
1/2
 Littauer
 14 cm/5 1/2"



1/4
 HM-71-3347



1/2
 Eiselsberg
 12 cm/4 3/4"



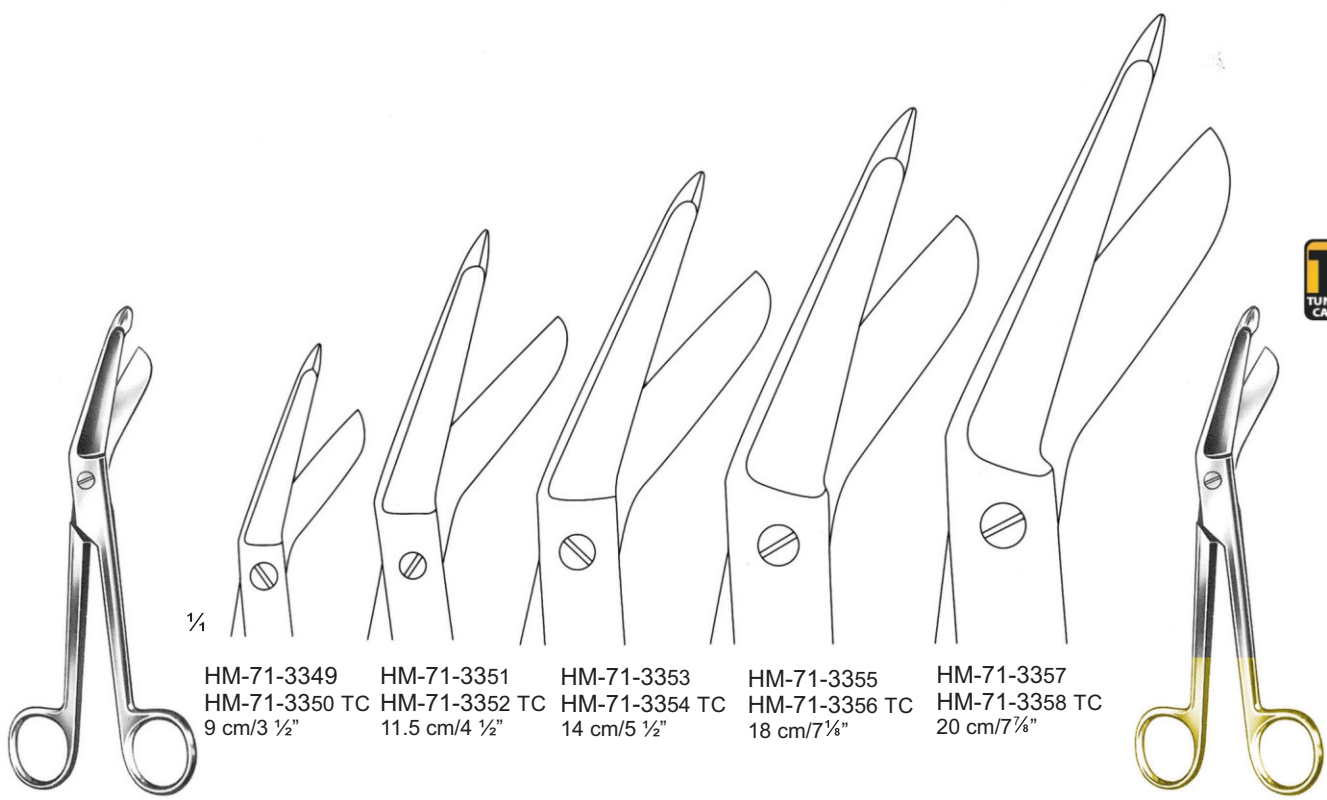
1/4
 HM-71-3348





- EN — Bandage scissors
- DE — Verbandscheren
- ES — Tijeras para vendajes
- FR — Ciseaux de pansement
- IT — Forbici per bende

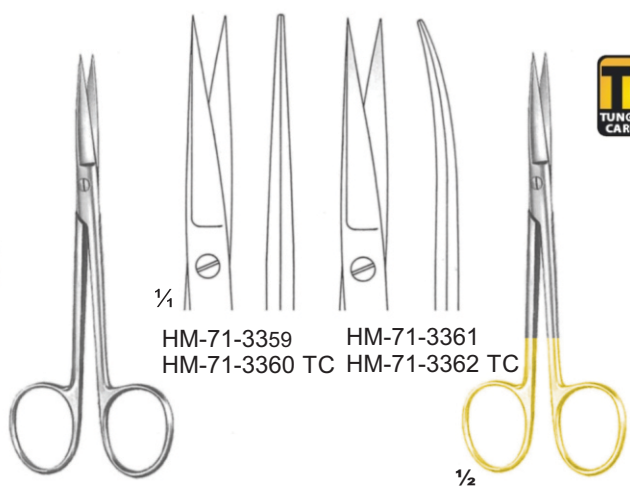
MOMAD DENTAL SUPPLIES



- HM-71-3349
9 cm/3 1/2"
- HM-71-3351
11.5 cm/4 1/2"
- HM-71-3353
14 cm/5 1/2"
- HM-71-3355
18 cm/7 1/8"
- HM-71-3357
20 cm/7 7/8"

LISTER

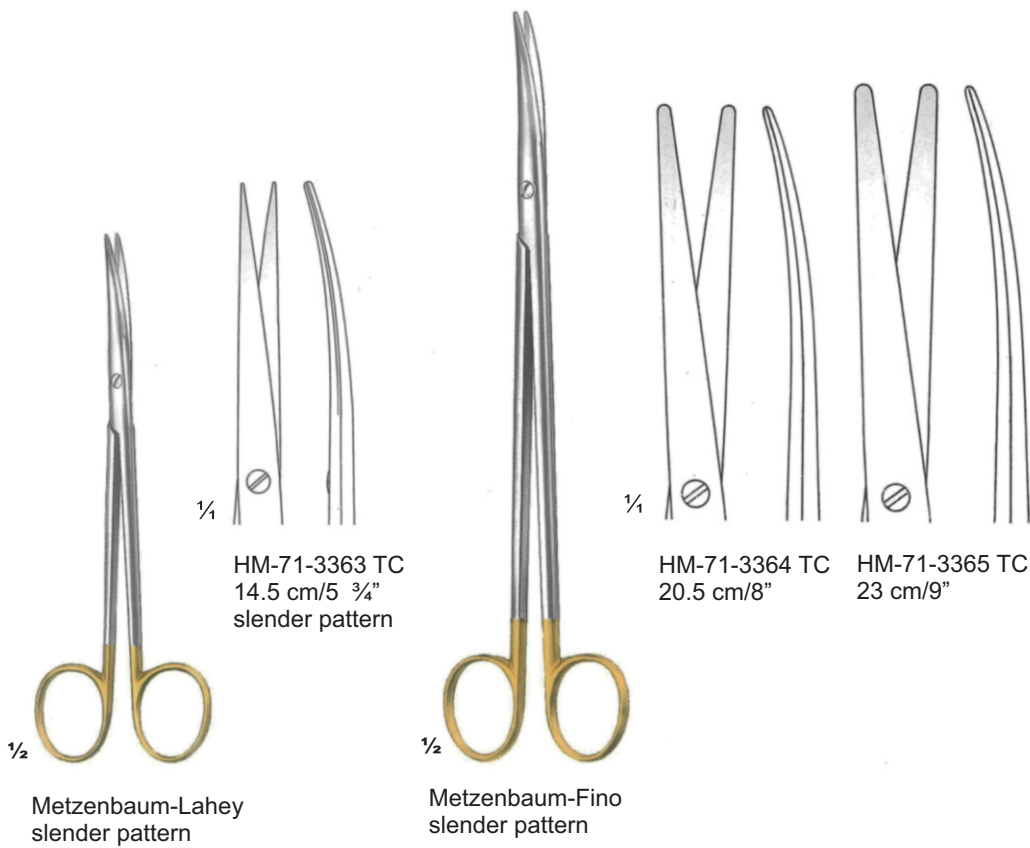
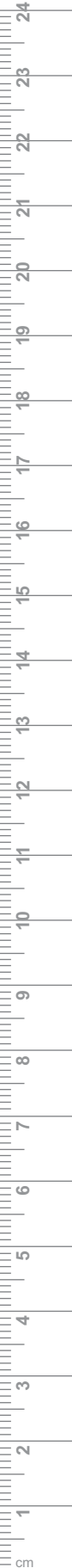
LISTER



- HM-71-3359
12 cm/4 3/4"
- HM-71-3361
12 cm/4 3/4"

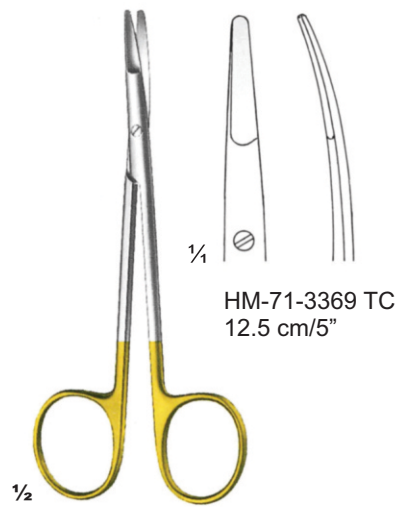
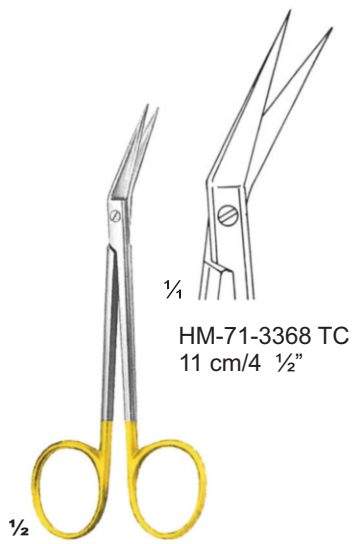
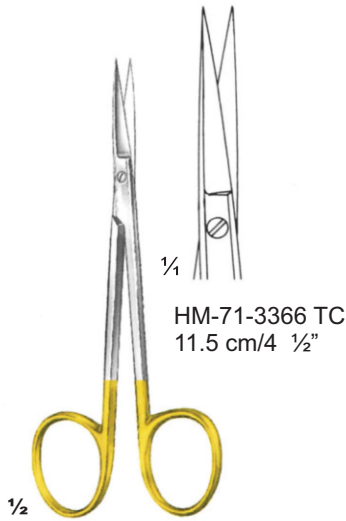
Wagner
12 cm/4 3/4"

Wagner
12 cm/4 3/4"

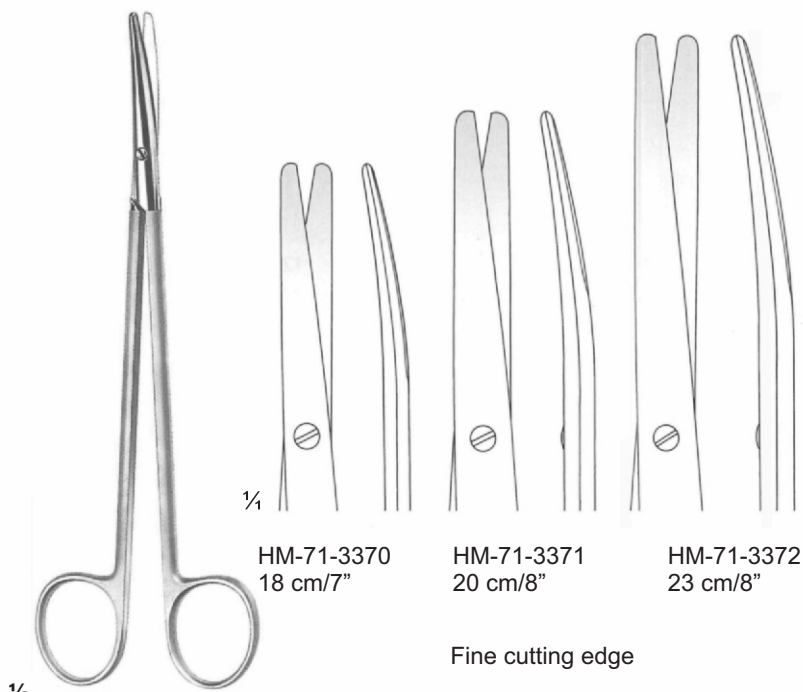




- EN —●— Gum scissors
- DE —●— Zahnflesischeren
- ES —●— Tijeras para encías
- FR —●— Ciseaux de gomme
- IT —●— Forbici da masticare



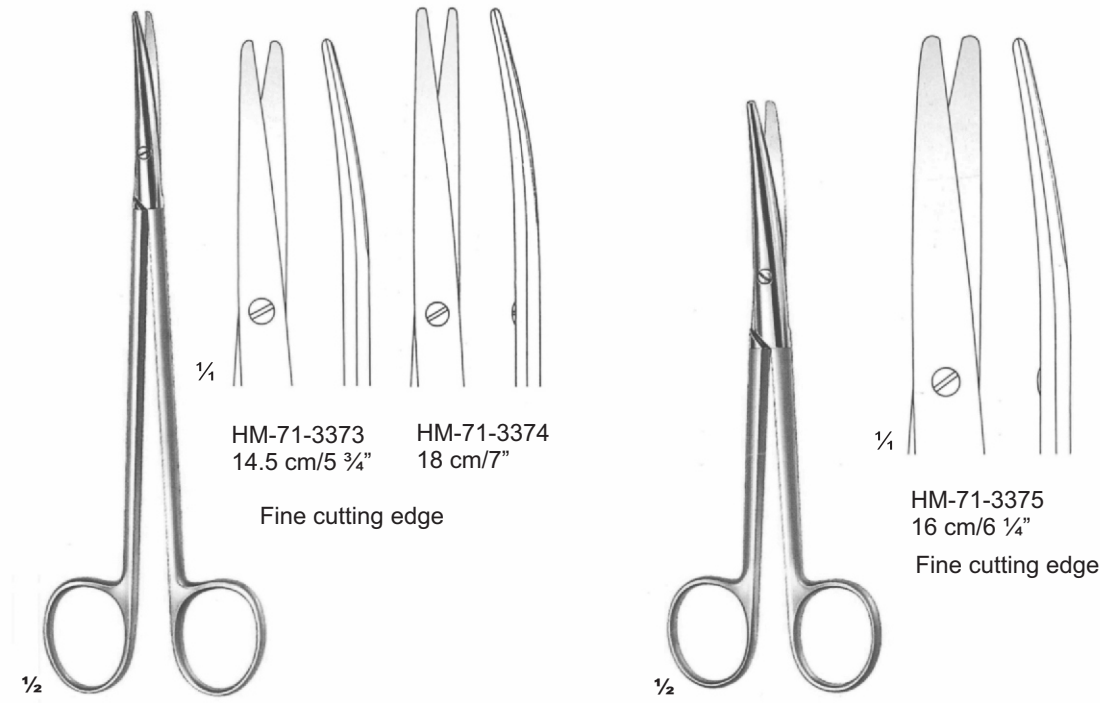
Ragnell



1/2

Metzenbaum

Fine cutting edge

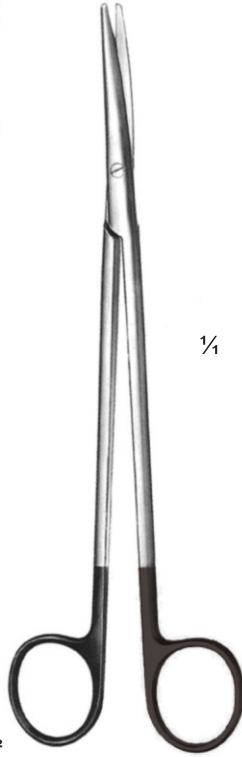


1/2

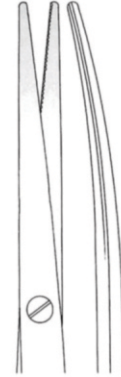
Metzenbaum

Mayo-Lexer
Standard Pattern





1/4

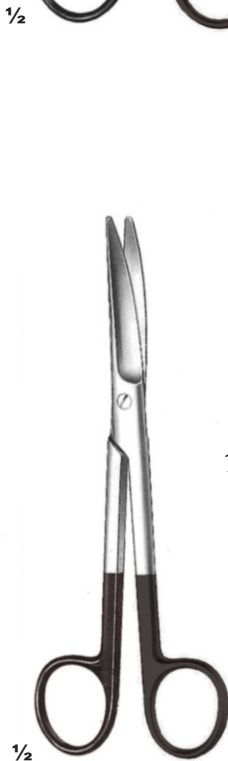


HM-71-3376 TCS
14.5 cm/5 3/4"



HM-71-3377 TCS
18 cm/7"

For synthetic suture material
One toothed cutting edge



1/2

1/4



HM-71-3378 TCS
14.5 cm/5 3/4"



HM-71-3379 TCS
17 cm/6 3/4"

For synthetic suture material
One toothed cutting edge

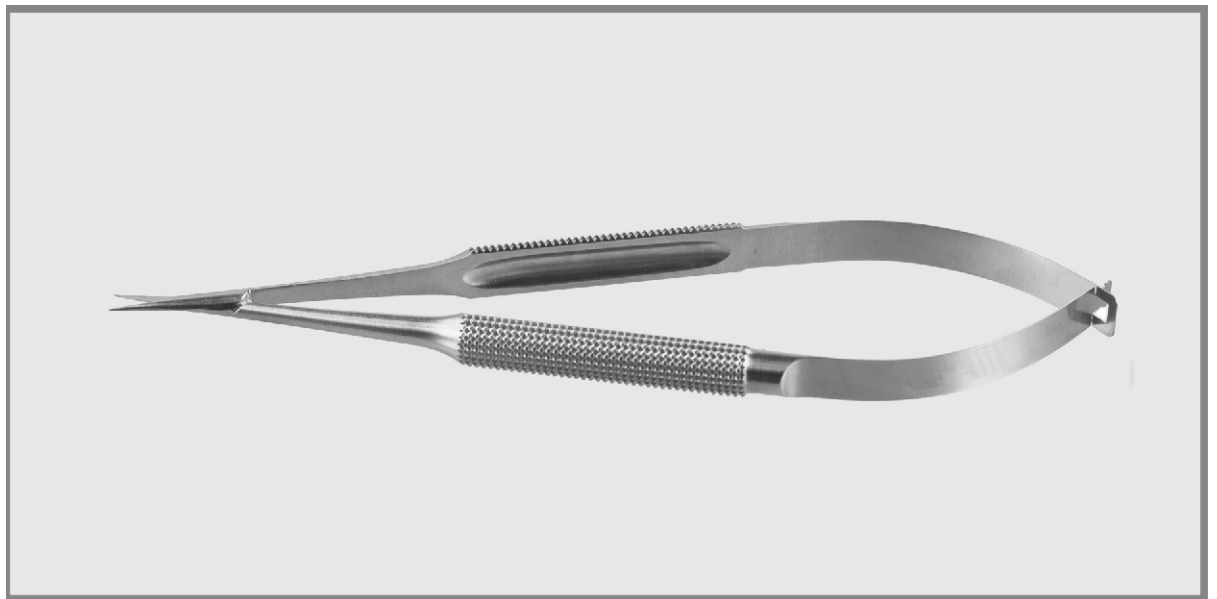


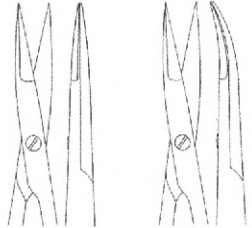
MOMAD DENTAL SUPPLIES

72

- EN** Micro Scissors
- DE** Mikroschere
- ES** Micro tijeras
- FR** Micro-ciseaux
- IT** Micro forbici

Page 172 to 173

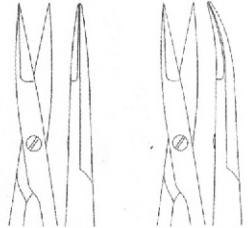
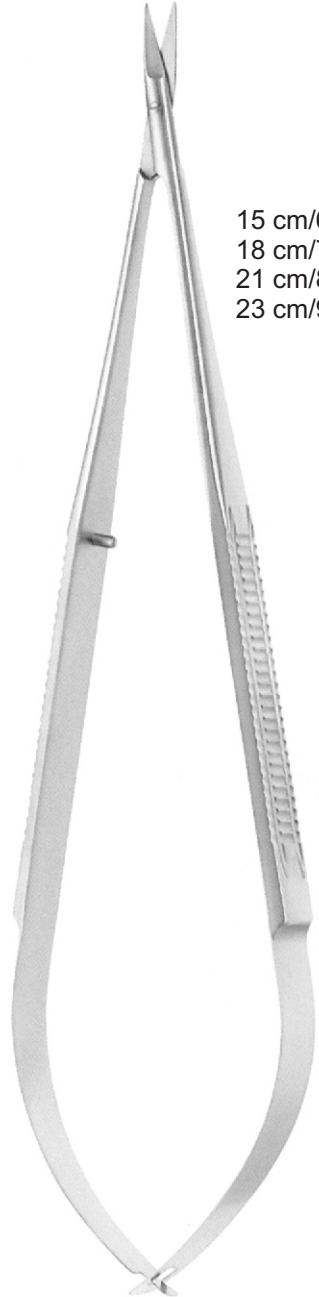




15 cm/6"	HM-72-3401	HM-72-3405
18 cm/7"	HM-72-3402	HM-72-3406
21 cm/8 ¼"	HM-72-3403	HM-72-3407
23 cm/9"	HM-72-3404	HM-72-3408



Streamlined



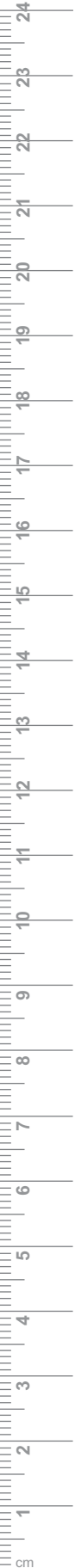
15 cm/6"	HM-72-3409	HM-72-3413
18 cm/7"	HM-72-3410	HM-72-3414
21 cm/8 ¼"	HM-72-3411	HM-72-3415
23 cm/9"	HM-72-3412	HM-72-3416



Streamlined



NOYES
HM-72-3417
13 cm/5"



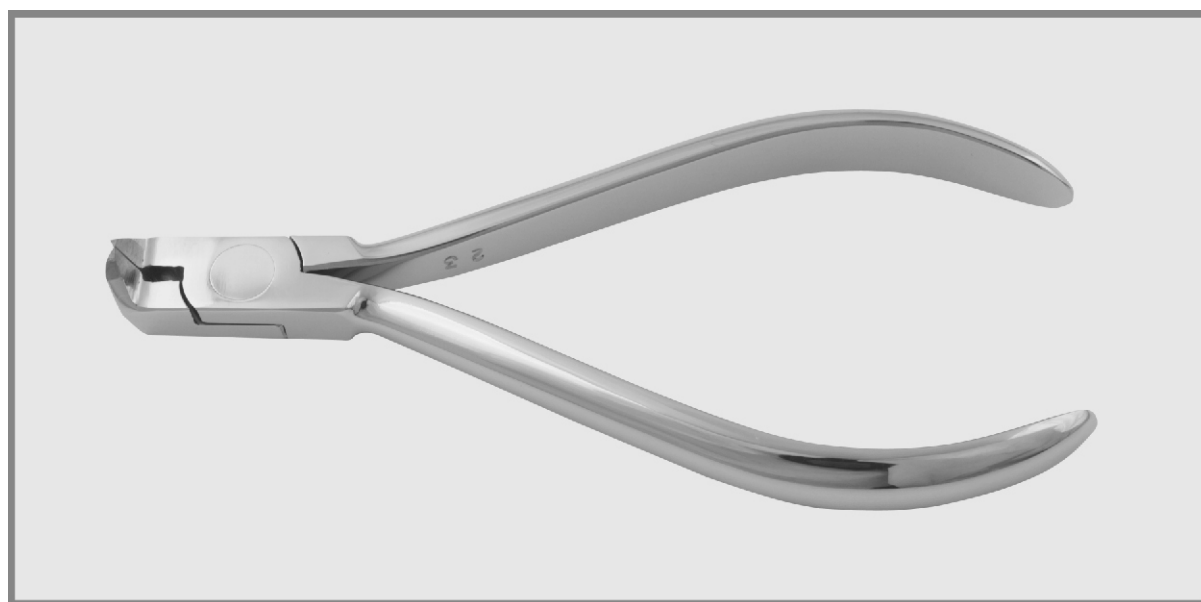


MOMAD DENTAL SUPPLIES

73

- | | |
|-----------|-------------------------|
| EN | Orthodontics |
| DE | Kieferorthopädie |
| ES | Ortodoncia |
| FR | Orthodontie |
| IT | Ortodonzia |

Page 174 to 190





- EN —● Flat nose pliers
- DE —● Rund-, Flachzange
- ES —● Pincas plates, rondes
- FR —● Alicates de pico plano
- IT —● Tenaglie piatte



5 mm
fluted

HM-73-3501
14 cm/5 1/2"



LANGENBECK
HM-73-3502
15 cm/6"



narrow, serrated

HM-73-3503
14 cm/5 1/2"



smooth

HM-73-3504
12,5 cm/4 3/4"



serrated

HM-73-3505
13 cm/5"



serrated

HM-73-3506
14 cm/5 1/2"



Contouring pliers

GOSLEE
 HM-73-3507
 14 cm/5 1/2"



Contouring pliers

GOSLEE
 HM-73-3508
 14 cm/5 1/2"



Contouring pliers

GOSLEE
 HM-73-3509
 14 cm/5 1/2"



serrated

HM-73-3510
 12,5 cm/4 3/4"



round

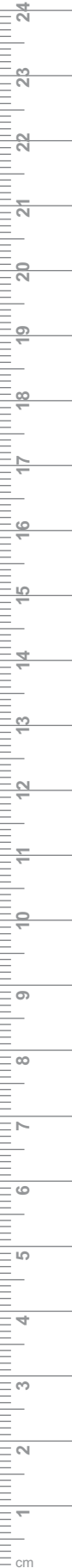
Flat

HM-73-3511
 15 cm/6"



round
 nose pliers

HM-73-3512
 13 cm/5"





- EN —● Flat and round nose pliers
- DE —● Flach-und Rundzangen
- ES —● Pincas á mors plats et ronds
- FR —● Alicates de picos planos y redondos
- IT —● Tenaglie a punte piatte e rotondo



HM-73-3513
13 cm/5"



HM-73-3514
13 cm/5"



LANGENBECK
HM-73-3515
14 cm/5 1/2"



DUMONT
HM-73-3516
11,5 cm/4 1/2"



DUMONT
HM-73-3517
11,5 cm/4 1/2"



DUMONT
HM-73-3518
11,5 cm/4 1/2"



Wire cutter, front action



HM-73-3519
 11 cm/4 1/4"



HM-73-3520
 11,5 cm/4 1/2"



HM-73-3521
 12,5 cm/4 3/4"



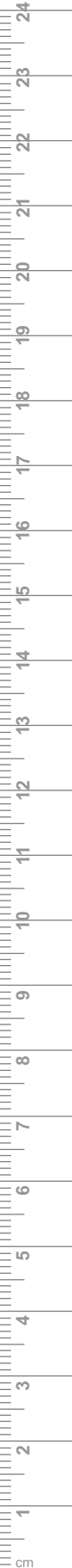
HM-73-3522
 11,5 cm/4 1/2"



HM-73-3523
 11,5 cm/4 1/2"



0,7 mmØ
 for hard wire up to





- EN —●— Wire Bending Pliers
- DE —●— Drahtbiegezangen
- ES —●— Alicates para doblar alambre
- FR —●— Pincés pour plier fil d'acier
- IT —●— Pinze piega fil



HM-73-3524
15 cm/6"

1,0 mm Ø
for hard wire up to



SCHWARZ
HM-73-3525
13 cm/5"
Modell I

SCHWARZ
HM-73-3528
14,5 cm/5 3/4"



SCHWARZ
HM-73-3526
13 cm/5"
Modell II

FISCHER
HM-73-3529
14 cm/5 1/2"



ANDRESEN
 HM-73-3530
 13,5 cm/5 1/2"

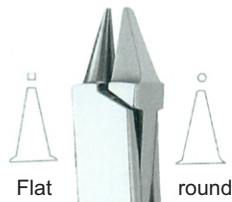


STADLER
 HM-73-3533
 15 cm/6"



sling forming pliers

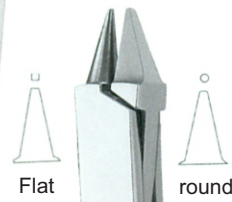
McKELLOPS
 HM-73-3531
 17 cm/6 3/4"



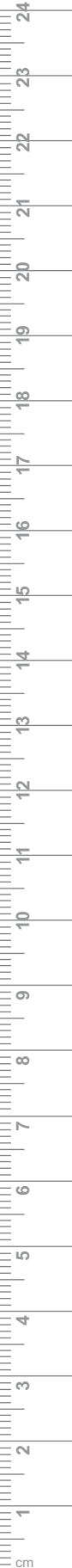
ANGLE
 HM-73-3534
 12,5 cm/5"



McKELLOPS-STADLER
 HM-73-3532
 16 cm/6 1/4"



ANGLE
 HM-73-3535
 12,5 cm/5"





- EN —● Wire Bending Pliers, Loop forming pliers
- DE —● Drahtbiegeezangen, Schlaufenbiegeezangen
- ES —● Alicates para doblar alambre, Alicates para pliegues
- FR —● Pincés pour plier fil d'acier, pincés á faconner
- IT —● Pinzo piega filo, pinze per pieghe



ADAMS
HM-73-3536
13 cm/5"



YOUNG
HM-73-3537
13 cm/5"



TWEED
HM-73-3538
13,5 cm/5 1/2"



TWEED
HM-73-3539
13,5 cm/5 1/2"



DE LA ROSA
HM-73-3540
12,5 cm/5"



DE LA ROSA
HM-73-3541
12,5 cm/5"

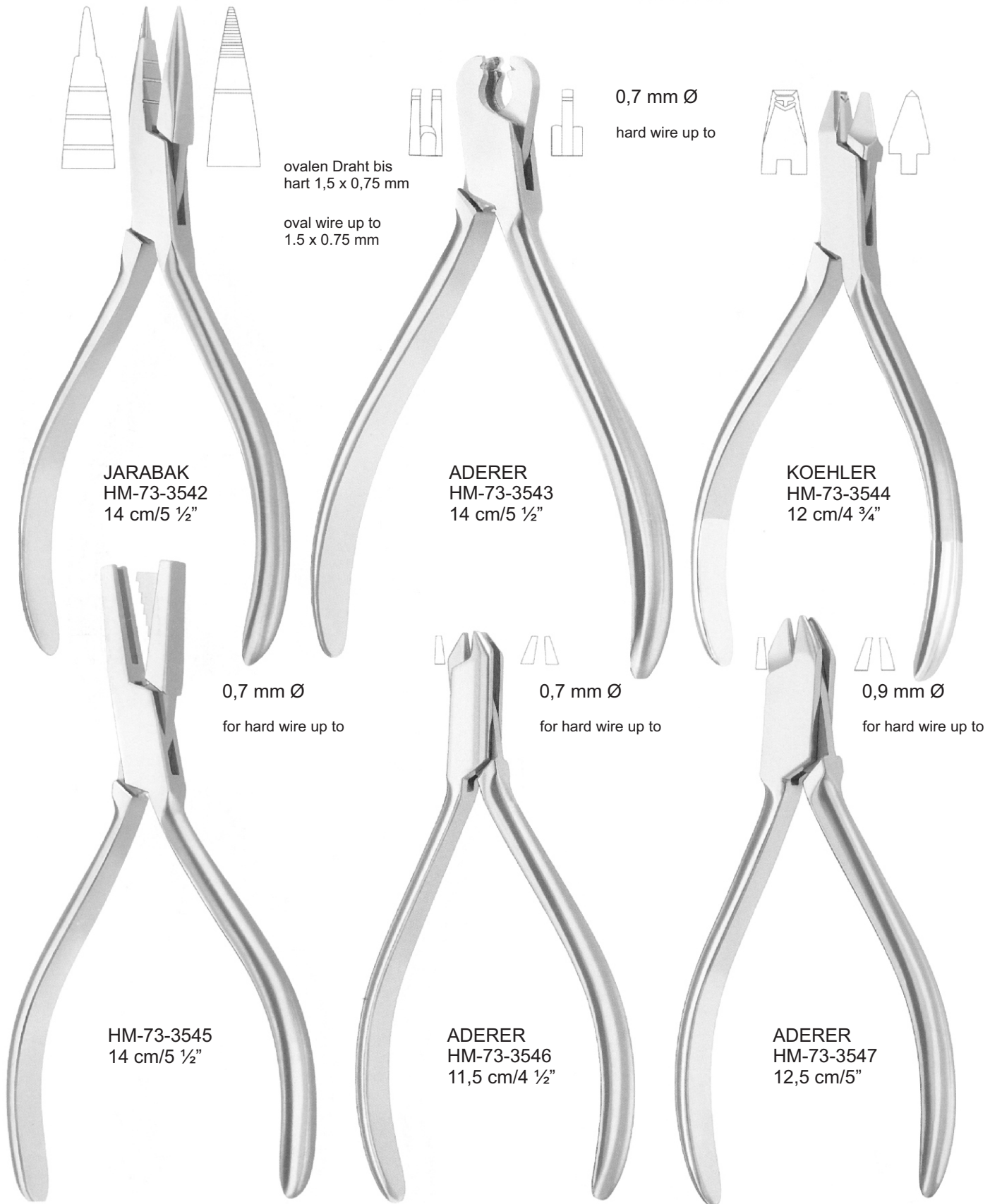
Contouring pliers

Wire, arch and clasp bending pliers
 Draht-, Bogen- und Klammernbiegezaugen
 Pincas à courber les fils, les branches et les agrafes
 Alicates para doblar alambres, arcos y ganchos
 Tenaglie per la piegatura di fili metallici, staffe graffe

- EN
- DE
- ES
- FR
- IT



MOMAD DENTAL SUPPLIES



JARABAK
 HM-73-3542
 14 cm/5 1/2"

ovalen Draht bis
 hart 1,5 x 0,75 mm

oval wire up to
 1.5 x 0.75 mm

0,7 mm Ø
 hard wire up to

ADERER
 HM-73-3543
 14 cm/5 1/2"

KOEHLER
 HM-73-3544
 12 cm/4 3/4"

0,7 mm Ø
 for hard wire up to

0,7 mm Ø
 for hard wire up to

0,9 mm Ø
 for hard wire up to

HM-73-3545
 14 cm/5 1/2"

ADERER
 HM-73-3546
 11,5 cm/4 1/2"

ADERER
 HM-73-3547
 12,5 cm/5"



- EN —●— Universal pliers, bridge removing pliers
- DE —●— Universal-Kramponzange, Bruckenabnehmezangen
- ES —●— Pincas universelles, pinces d' extraction de bridge
- FR —●— Alicates universales, alicates para puentes
- IT —●— Tenaglie universali, tanaglie pone di ponticeller la rimozii



Bending Pliers

ANGLE
HM-73-3548
13 cm/5"



ANGLE
HM-73-3549
13 cm/5"



WALDSACHS
HM-73-3550
15,5 cm/6"



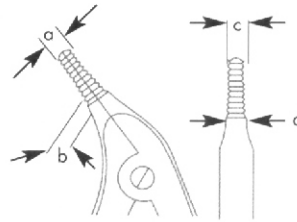
Universal
HM-73-3551
15,5 cm/6 1/4"



HM-73-3552
15,5 cm/6 1/4"

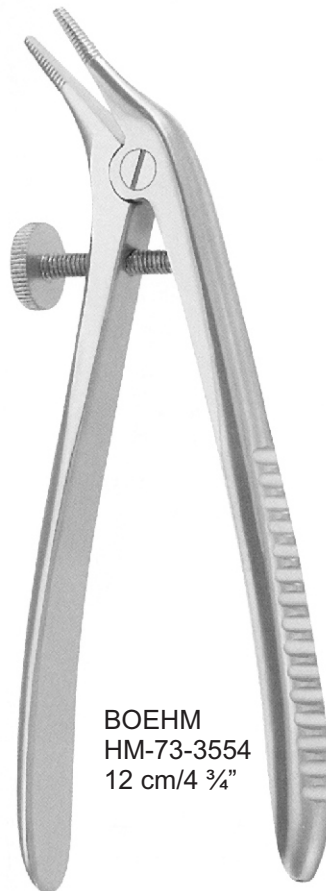


FURRER
HM-73-3553
15 cm/6"



a	b	c	d
3,3	4	2,3	3,0
4,4	5	3,4	3,8

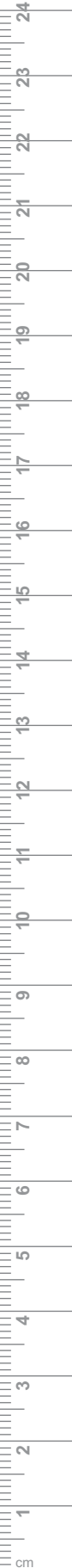
Telescope crown pliers



BOEHM
 HM-73-3554
 12 cm/4 3/4"



BOEHM
 HM-73-3555
 15 cm/4"





- EN —● Band removing pliers
- DE —● Bandabnehmzangen
- ES —● Alicatas para quitar bandas
- FR —● Pince à enlever les bagues
- IT —● Pinze asportabande



OLIVER JONES
HM-73-3556
15 cm/6"



OLIVER
HM-73-3557
15 cm/6"



OLIVER
HM-73-3558
15 cm/6"

Step loop bending pliers



ADERER
HM-73-3559
13,5 cm/5 1/4"



NANCE
HM-73-3560
12,5 cm/5"



0,7 mm Ø

for hard wire up to





- EN Contouring pliers, Crown pliers
- DE Konturzangen, Kronenzangen
- ES Pincas á couronne, pincas de contours
- FR Alicates para coronas y para contornear
- IT Tenaglie per corone, tenaglie per profili



TRYFUS
HM-73-3567
16 cm/6 1/4"

Crown stretching pliers



PEESO
HM-73-3570
14 cm/5 1/2"



PEESO
HM-73-3568
12 cm/6 1/4"

smooth



HOW
HM-73-3571
14 cm/5 1/2"

straight



PEESO
HM-73-3569
13,5 cm/5 1/4"

serrated



HOW
HM-73-3572
14 cm/5 1/2"

curved



HM-73-3573
 18 cm/7"



HM-73-3574
 14,5 cm/5 ¾"





- EN —●— Contouring pliers
- DE —●— Konturzangen
- ES —●— Pincas a couronne
- FR —●— Alicates para contornear
- IT —●— Tenaglie per corone



FREVERT
HM-73-3575
12 cm/4 3/4"



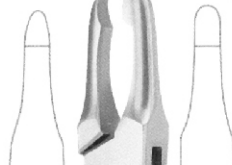
TRIPLEX
HM-73-3576
14 cm/5 1/2"



REYNOLD
HM-73-3577
12 cm/4 3/4"



GORDON
HM-73-3578
13,5 cm/5 1/4"



JOHNSON
HM-73-3579
13 cm/5"



Clamping tweezer / bracket holder



HM-73-3580 HM-73-3581 HM-73-3582 HM-73-3583 HM-73-3584 HM-73-3585 HM-73-3586 HM-73-3587
 Bracket P. Gauge HM-73-3588 HM-73-3589
 Band Remover Band Remover

Bracket positioning gauge



HM-73-3590





HM-73-3591
12.5 cm/5"



HM-73-3592
12.5 cm/5"



HM-73-3593
12.5 cm/5"



HM-73-3594
12.5 cm/5"



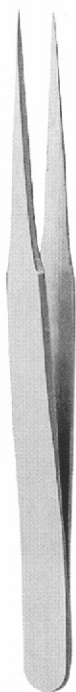
HM-73-3595
12.5 cm/5"



HM-73-3596
12.5 cm/5"



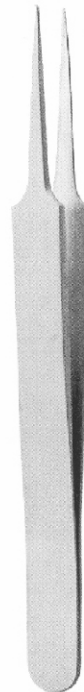
HM-73-3597
12.5 cm/5"



HM-73-3598
12.5 cm/5"



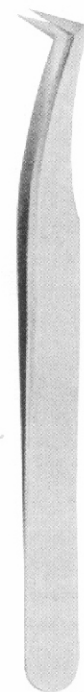
HM-73-3599
12.5 cm/5"



HM-73-3600
12.5 cm/5"



HM-73-3601
12.5 cm/5"



HM-73-3602
12.5 cm/5"

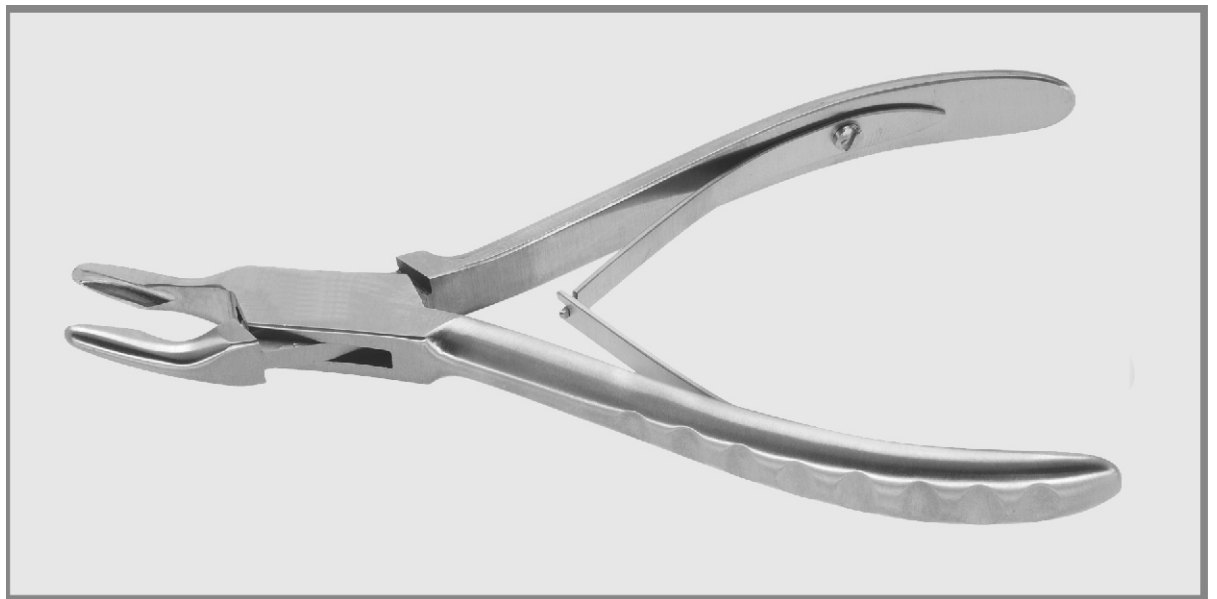


MOMAD DENTAL SUPPLIES

74

- EN** Bone Rongeurs
- DE** Knochen Rongeur
- ES** Rongeurs de hueso
- FR** Os Rongeurs
- IT** Bone Rongeurs

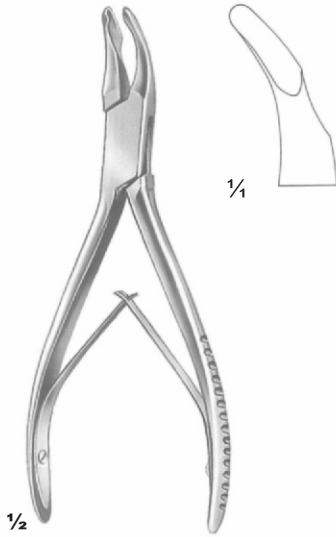
Page 191 to 193



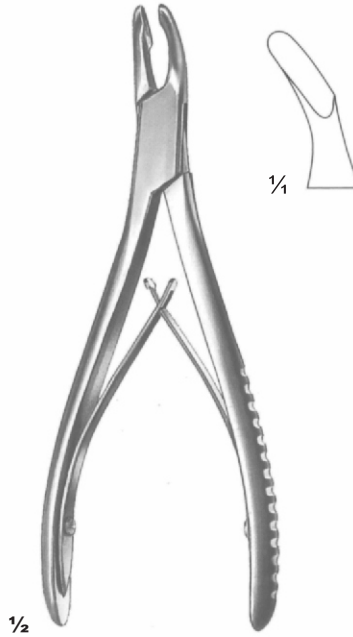


- EN — Bone Rongeurs
- DE — Knochenzange
- ES — Roedores de hueso
- FR — Bone Rongeur
- IT — Roditori di ossa

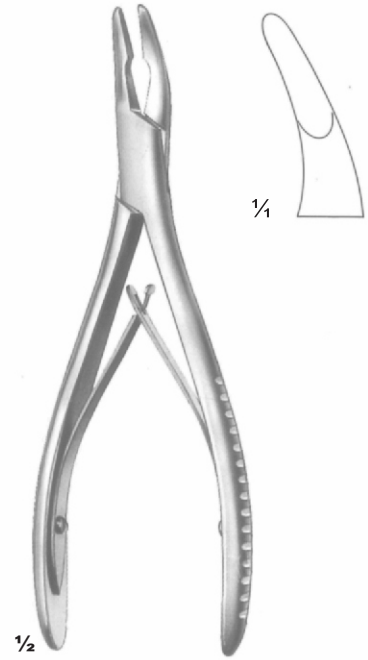
MOMAD DENTAL SUPPLIES



Cleveland
HM-74-3701
15 cm



Cleveland
HM-74-3702
15 cm



Hartmann
HM-74-3703
18 cm



LUER
15 cm



HM-74-3704



HM-74-3705



HM-74-3706



BLUMENTHAL
15 cm



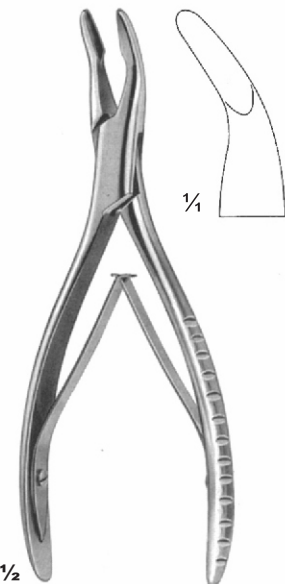
HM-74-3707
16 cm/6 1/4"



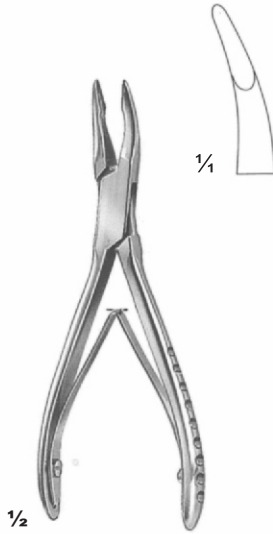
HM-74-3708
15.5 cm/6 1/8"



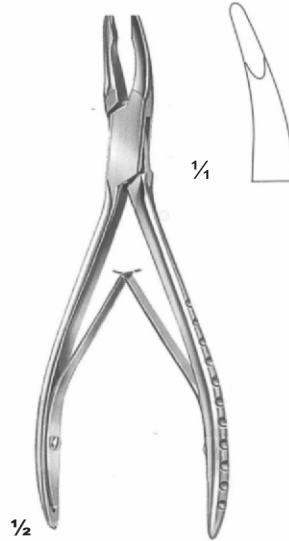
HM-74-3709
15.5 cm/6 1/8"



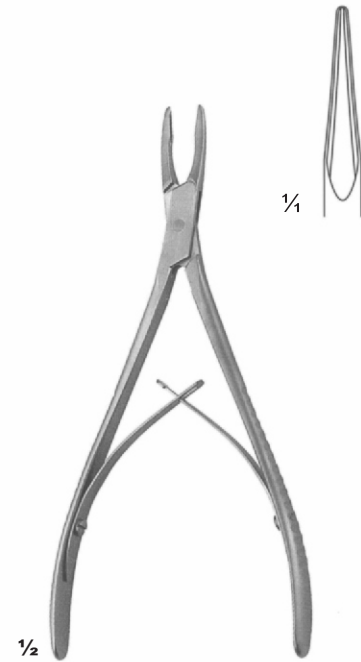
MEAD
HM-74-3710
16.5 cm/6 1/2"



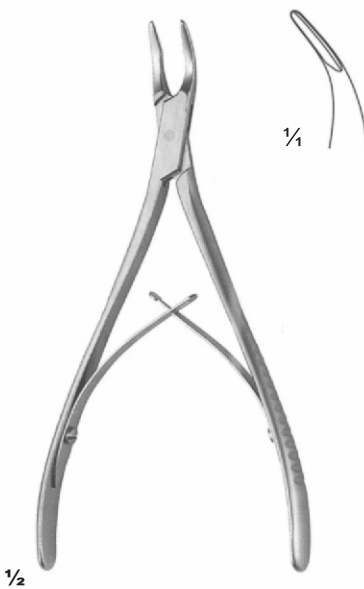
Friedmann
 HM-74-3711
 14 cm



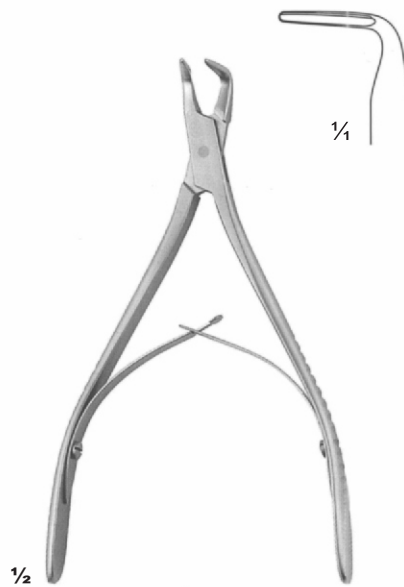
Friedmann
 HM-74-3712
 14 cm



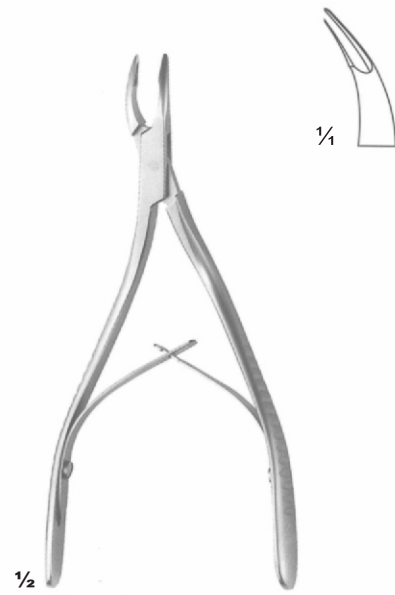
Friedmann-Micro
 HM-74-3713
 15 cm/6"
 straight



Friedmann-Micro
 HM-74-3714
 15 cm/6"
 30°



Friedmann-Micro
 HM-74-3715
 14.5 cm/5 3/4"
 90°

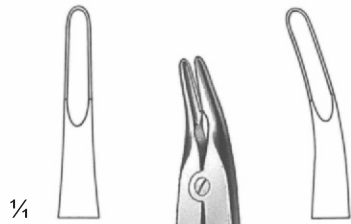


Friedmann-Micro
 HM-74-3716
 14.5 cm/5 3/4"
 S shape
 30°

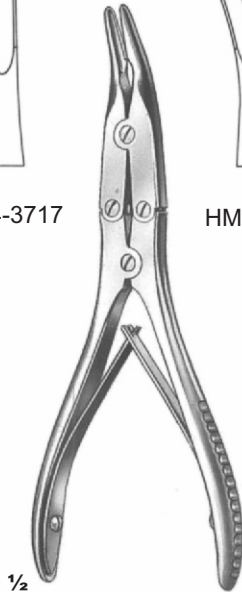




- EN —● Bone Rongeurs
- DE —● Knochenagetierte
- ES —● Roedores de hueso
- FR —● Bone Rongeur
- IT —● Roditori di ossa



HM-74-3717



Bohler
15.5 cm/6"

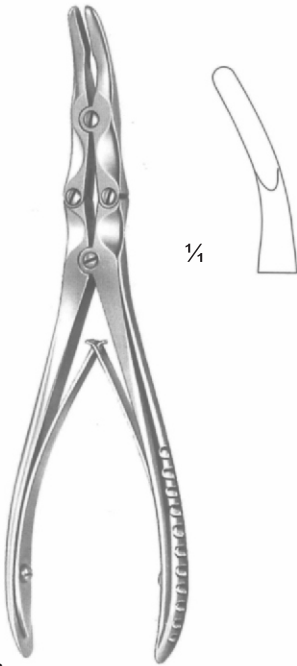


HM-74-3718

Roditori di ossa



Beyer
HM-74-3719
18 cm/7"

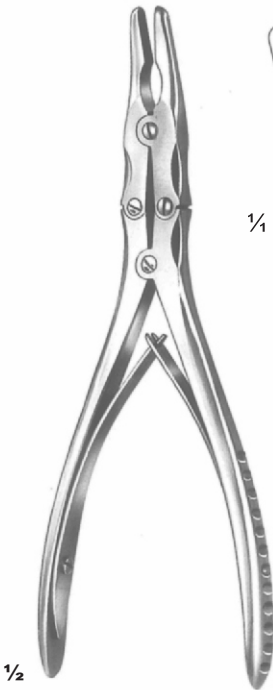


1/2

Mayfield
HM-74-3720
18 cm/7"



1/4

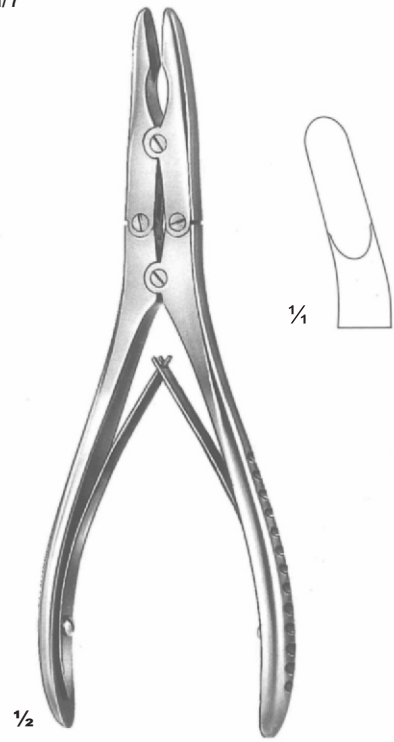


1/2

Zaufal-Jansen
HM-74-3721
18 cm/7"



1/4



1/2

Ruskin
HM-74-3722
19 cm/7 1/2"



1/4

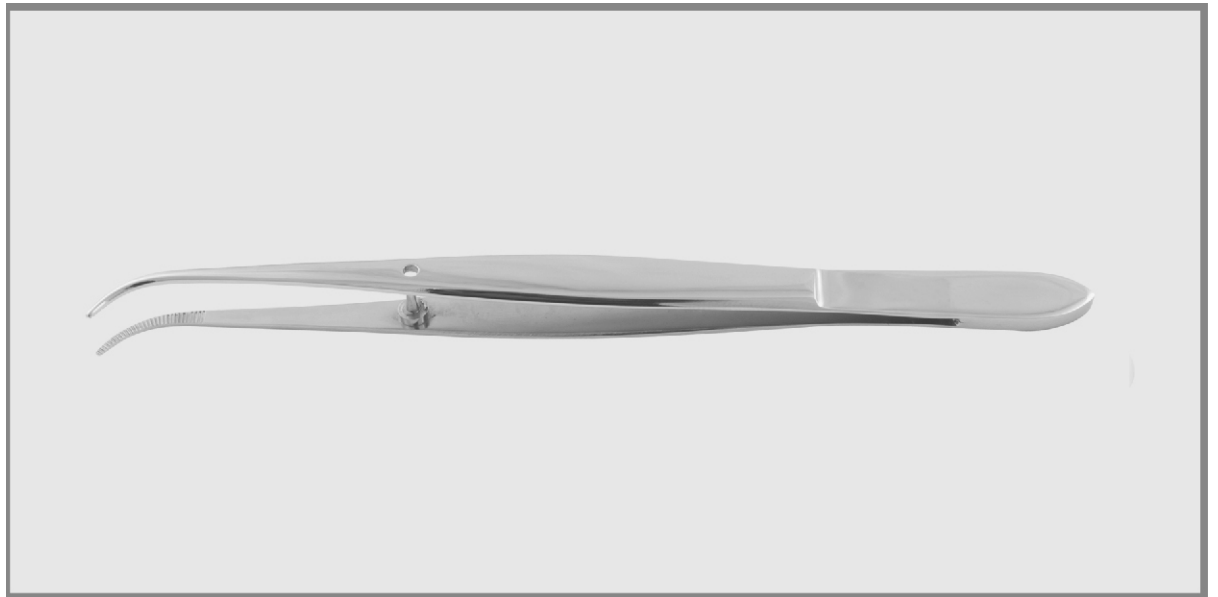


MOMAD DENTAL SUPPLIES

75

EN	Forceps
DE	Zange
ES	Fórceps
FR	Forceps
IT	forcipe

Page 194 to 201





- EN —●— Dressing Forceps
- DE —●— Verbandzange
- ES —●— Vendaje de fórceps
- FR —●— Pince à pansement
- IT —●— Pinze per medicazione



1/2

standard pattern

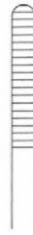


HM-75-3801
13 cm/5 1/8"

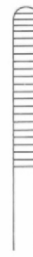
1/4



HM-75-3802
14.5 cm/5 3/4"



HM-75-3803
16 cm/5 1/4"



HM-75-3804
18 cm/7"



1/4

HM-75-3805
20 cm/7 7/8"



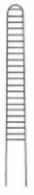
1/2

slender pattern



HM-75-3806
13 cm/5 1/8"

1/4



HM-75-3807
14.5 cm/5 3/4"

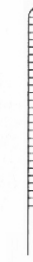


HM-75-3808
16 cm/5 1/4"

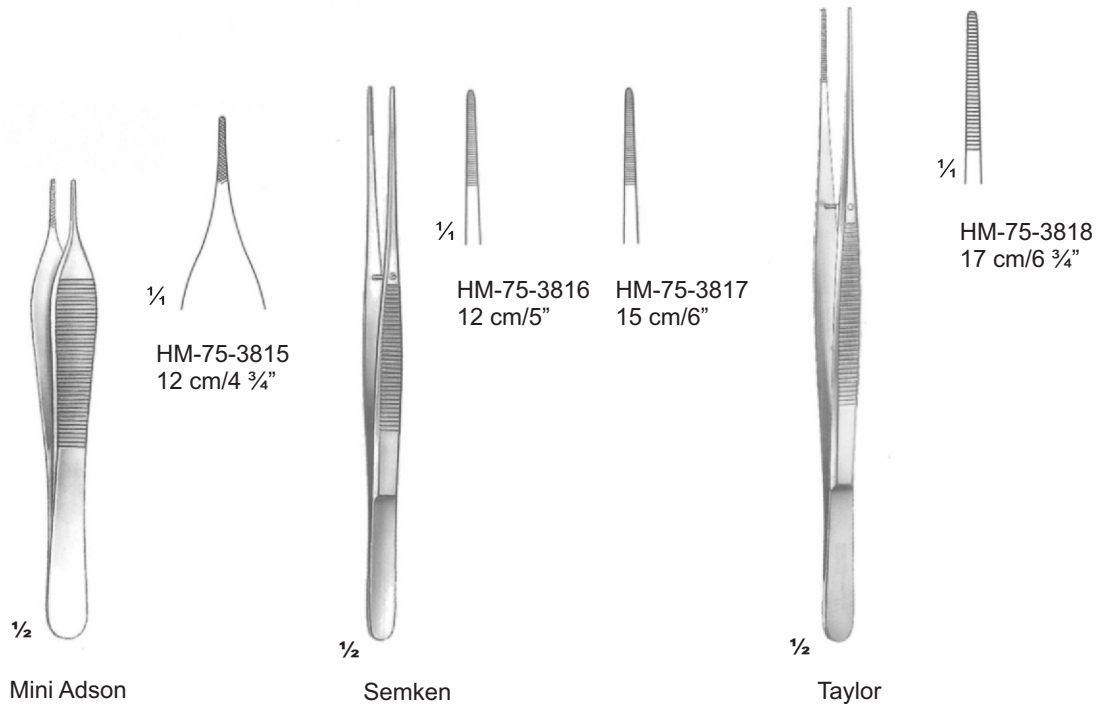
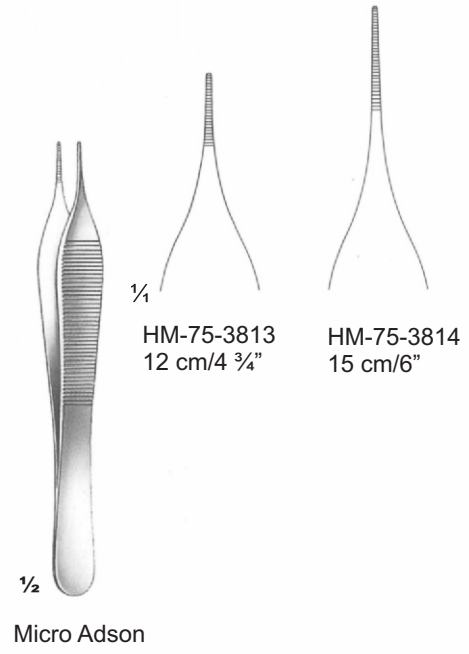
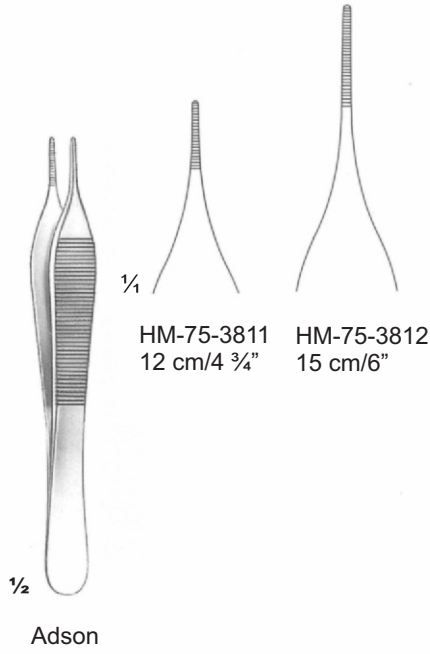


HM-75-3809
18 cm/7"

1/4



HM-75-3810
20 cm/7 7/8"





- EN —●— Dressing Forceps
- DE —●— Verbandzange
- ES —●— Vendaje de fórceps
- FR —●— Pince à pansement
- IT —●— Pinze per medicazione



HM-75-3819	HM-75-3820	HM-75-3821	HM-75-3822	HM-75-3823
13 cm/5 1/8"	14.5 cm/5 3/4"	16 cm/6 1/4"	18 cm/7"	20.5 cm/8 1/8"
1x2	1x2	1x2	1x2	1x2

Standard Pattern



HM-75-3824	HM-75-3825	HM-75-3826	HM-75-3827	HM-75-3828
13 cm/5 1/8"	14.5 cm/5 3/4"	16 cm/6 1/4"	18 cm/7"	20.5 cm/8 1/8"
1x2	1x2	1x2	1x2	1x2

Slender Pattern



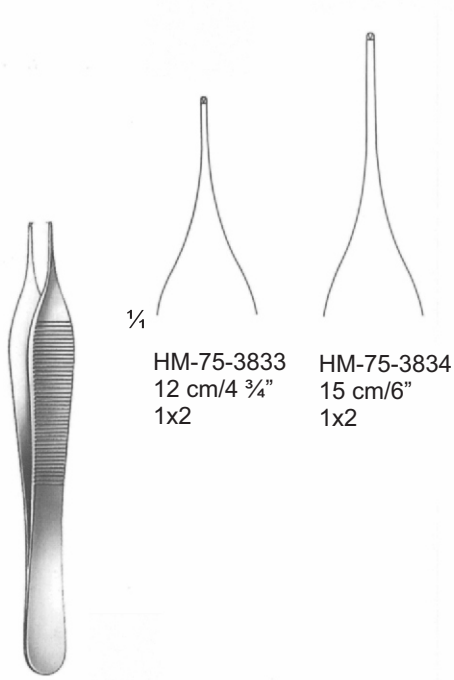
HM-75-3829	HM-75-3830
12 cm/4 3/4"	15 cm/5 7/8"
1x2	1x2

Adson



HM-75-3831	HM-75-3832
12 cm/4 3/4"	12 cm/4 3/4"
1x2	1x2

Mini Adson

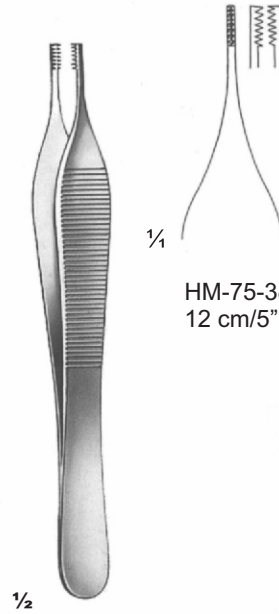


1/4

HM-75-3833
 12 cm/4 3/4"
 1x2

HM-75-3834
 15 cm/6"
 1x2

Mikro Adson

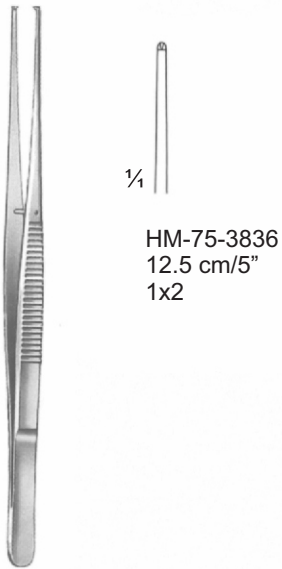


1/4

HM-75-3835
 12 cm/5"

1/2

Adson-Brown

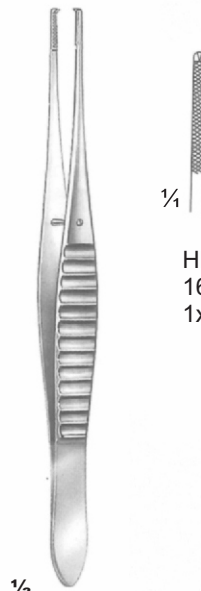


1/4

HM-75-3836
 12.5 cm/5"
 1x2

HM-75-3837
 15 cm/6"
 1x2

Semken

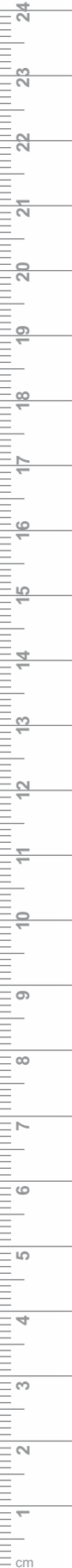


1/4

HM-75-3838
 16 cm/6 1/2"
 1x2

1/2

Gillies





- EN —●— Dressing Forceps
- DE —●— Verbandzange
- ES —●— Vendaje de fórceps
- FR —●— Pince à pansement
- IT —●— Pinze per medicazione

MOMAD DENTAL SUPPLIES



1/4
HM-75-3838A
15 cm/6"

suited to hold silver pins, nerve-broaches and for introducing medicines



1/2

Suture and membrane forceps

D = 1,6 mm



1/4
HM-75-3839
16 cm/6 1/4"

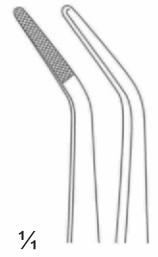
D = 2,2 mm



1/4
HM-75-3840
16 cm/6 1/4"



1/2



1/4
HM-75-3841
16 cm/6 1/4"



1/2
London-College
15 cm/6"



1/4
HM-75-3842
No. 1



HM-75-3843
No. 3



HM-75-3844
No. 5

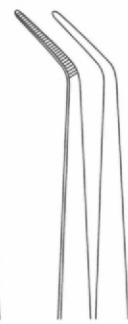


1/2

London-College
with lock
15 cm/6"



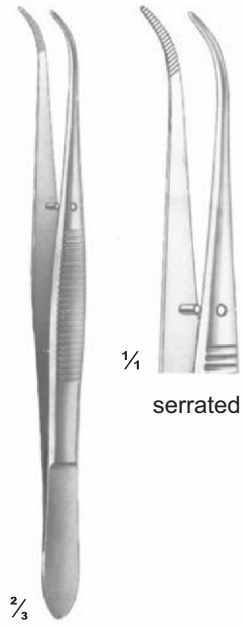
1/4
HM-75-3845
No. 1



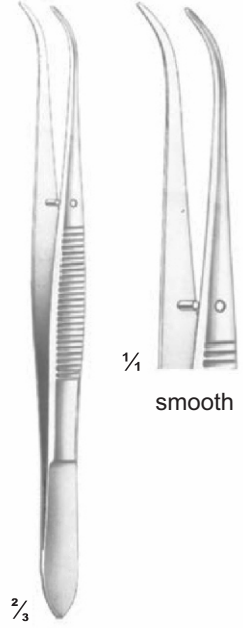
HM-75-3846
No. 3



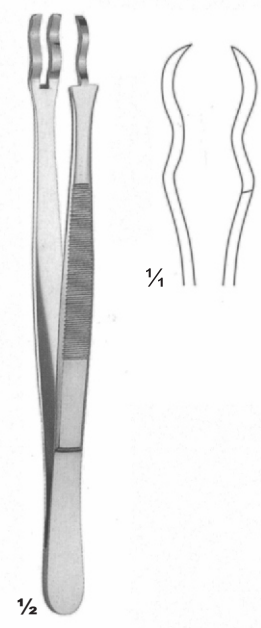
HM-75-3847
No. 5



Perry
 HM-75-3848
 13 cm/5"



Perry
 HM-75-3849
 13 cm/5"



HM-75-3850
 14.5 cm/5 3/4"
 Frigz
 Grasping and
 sterilizing forceps



HM-75-3851
 20 cm/8"
 Seizing and
 Sterilizing Forceps



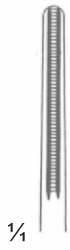


- EN —●— Dressing Forceps
- DE —●— Verbandzange
- ES —●— Vendaje de fórceps
- FR —●— Pince à pansement
- IT —●— Pinze per medicazione

MOMAD DENTAL SUPPLIES



DeBakey
12 cm/5"



HM-75-3852
2,7 mm



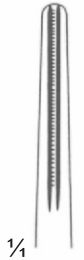
HM-75-3853
1,5 mm



HM-75-3854
2,0 mm



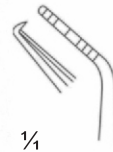
HM-75-3855
2,0 mm



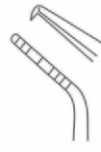
HM-75-3856
3,5 mm



Crane-Kaplan
Pocket marking forceps
15 cm/6"



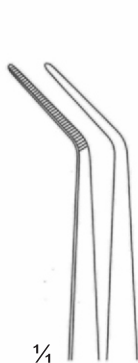
HM-75-3857
No. 1



HM-75-3858
No. 2



Meriam
16 cm/6 1/4"



HM-75-3859
No. 1



HM-75-3860
No. 3



HM-75-3861
No. 5



Flagg
16 cm/6 1/4"



HM-75-3862
No. 1



HM-75-3863
No. 2



HM-75-3864
No. 3



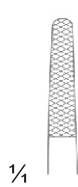
HM-75-3865
No. 4



Standard

HM-75-3866 TC
 14.5 cm/5 3/4"

HM-75-3867 TC
 18 cm/7"



1/4



delicate

HM-75-3868 TC
 14.5 cm/5 3/4"

HM-75-3869 TC
 18 cm/7"



1/4



1/2

Adson



1/4

HM-75-3870 TC
 12 cm/4 3/4"
 1x2



HM-75-3871 TC
 15 cm/6"
 1x2

mini profile



1/2

Gillies
 HM-75-3872 TC
 15.5 cm/6"
 1x2



1/4

mini profile



1/2

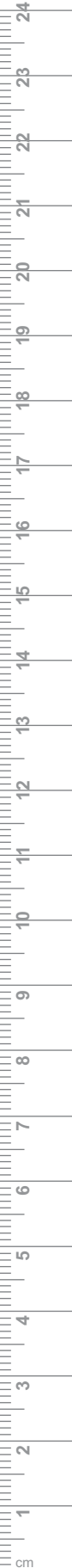
DeBakey
 HM-75-3873 TC
 16 cm/6 1/4"

ATRAUMA



1/4

micro profile



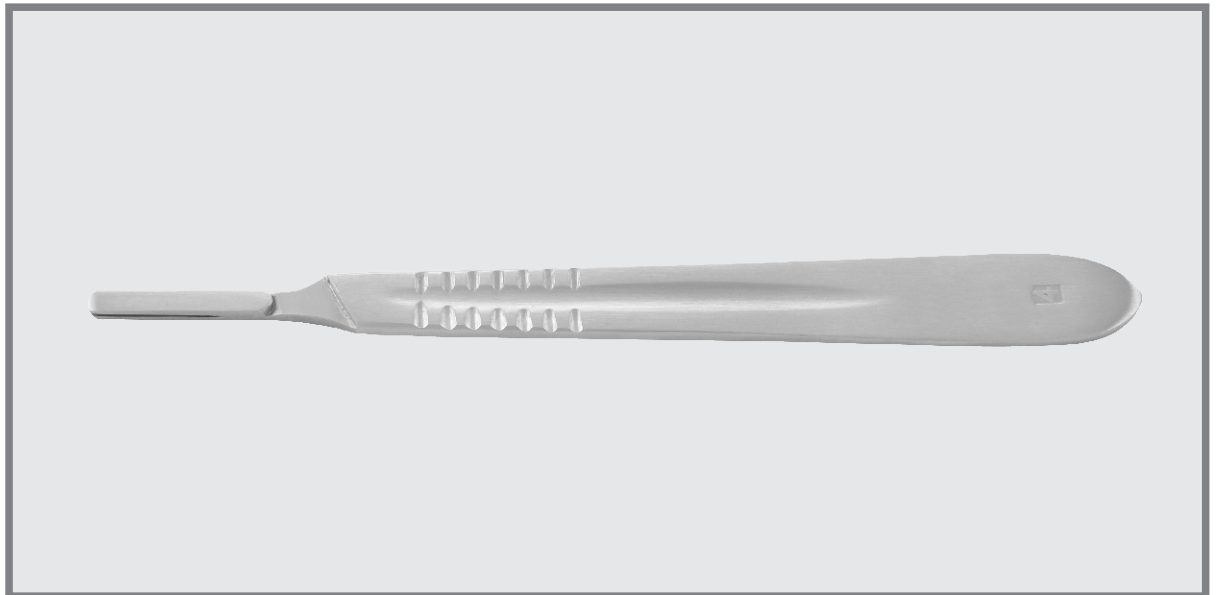


MOMAD DENTAL SUPPLIES

76

- EN** Scalpel Handles
- DE** Skalpellgriffe
- ES** Manches de bistouris
- FR** Mangos de Bisturías
- IT** Manici per bisturi

Page 202 to 203



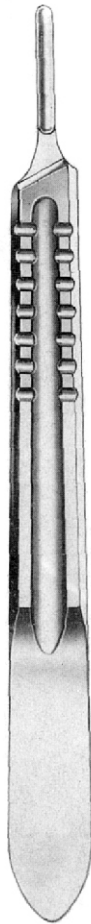


MOMAD DENTAL SUPPLIES

- EN —●— Scalpel Handles
- DE —●— Skalpell-Griffe
- ES —●— Mangos de bisturios
- FR —●— Poignées de scalpel
- IT —●— Manici per bisturi



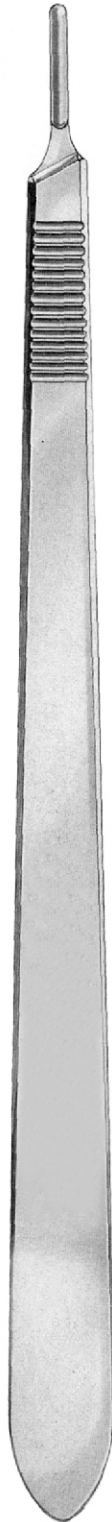
Standard
HM-76-3901 # 3



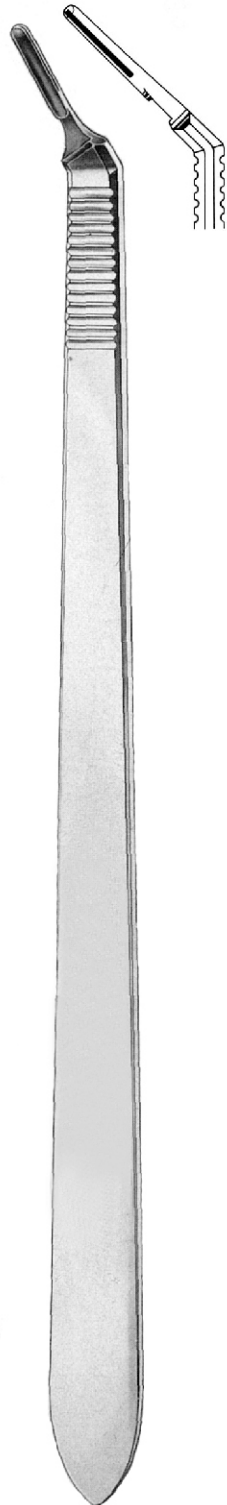
HM-76-3902 # 3



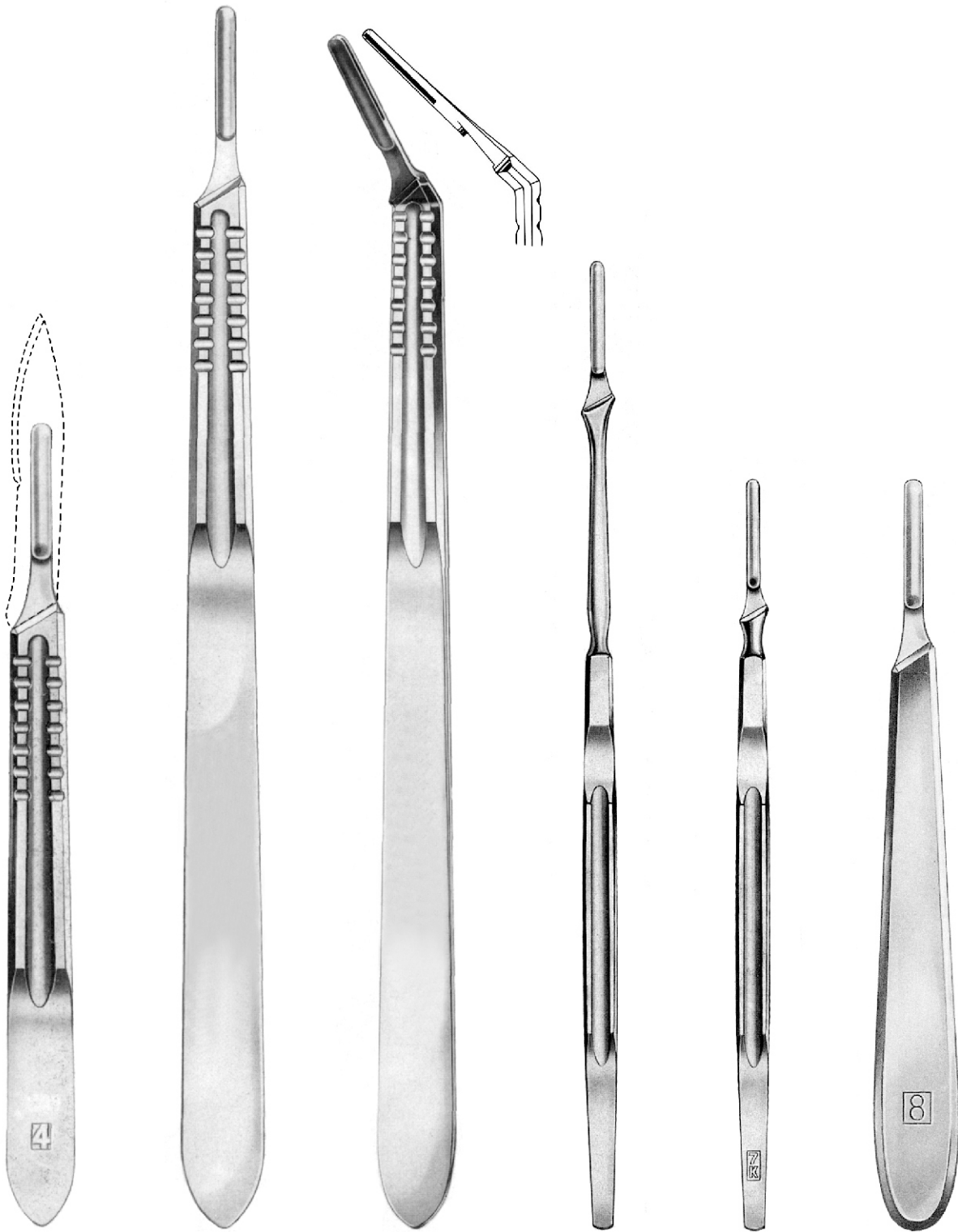
HM-76-3903 # 3
with scale



HM-76-3904-3L # 3L
HM-76-3905-3XL # 3XL



HM-76-3906-3L # 3L
HM-76-3907-3XL # 3XL
angled



Standard
 HM-76-3908
 # 4

HM-76-3909-4L # 4L
 HM-76-3910-4XL # 4XL

HM-76-3911-4L # 4L
 HM-76-3912-4XL # 4XL
 angled

HM-76-3913
 # 7

HM-76-3914
 # 7K

Collin
 HM-76-3915
 Fig. 8

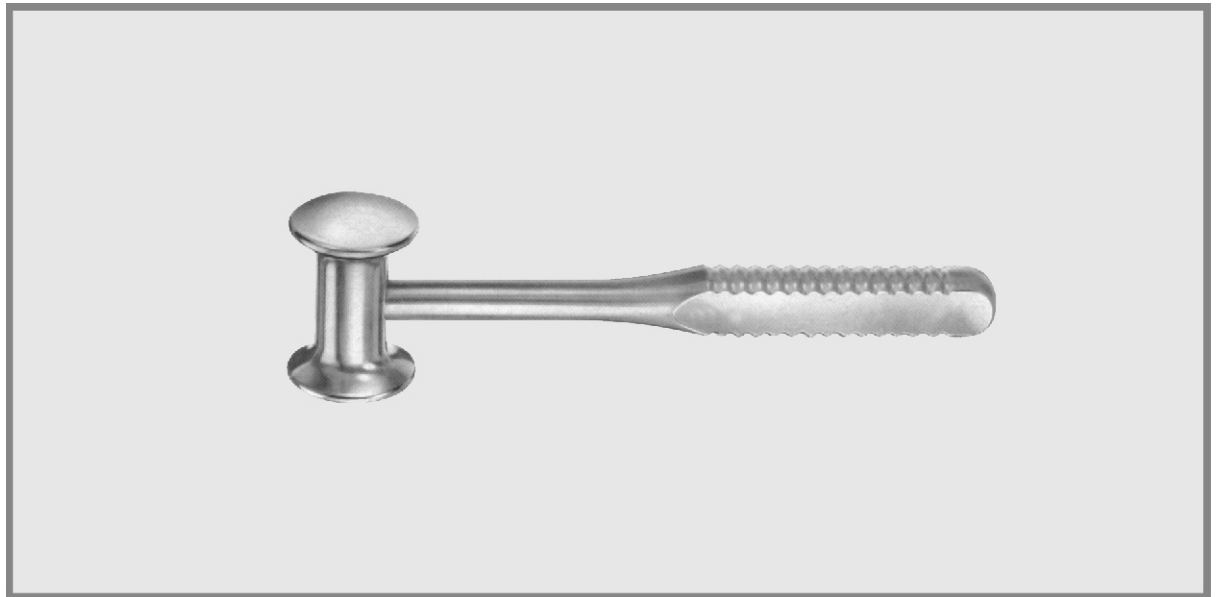


MOMAD DENTAL SUPPLIES

77

EN	Mallets
DE	Schlägel
ES	Mazos
FR	Maillets
IT	Mallets

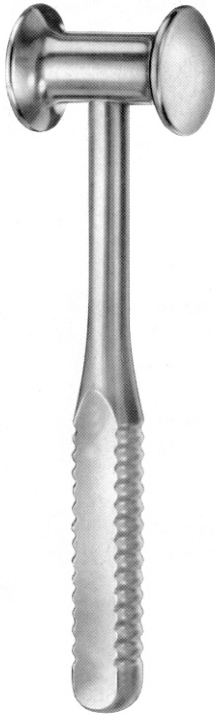
Page 204 to 206





- EN —● Mallets
- DE —● Hämmer
- ES —● Martillos
- FR —● Maillets
- IT —● Mallets

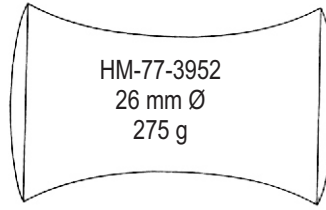
MOMAD DENTAL SUPPLIES



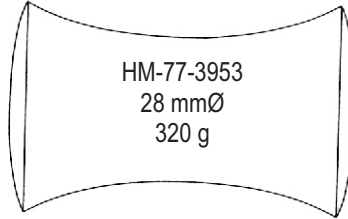
BERGMANN
HM-77-3951
24 cm/9 1/2"
300 grams



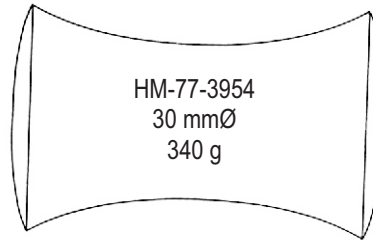
WILLIGER
24 cm/9 1/2"
lead filled



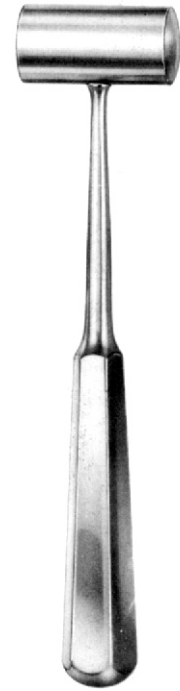
HM-77-3952
26 mm Ø
275 g



HM-77-3953
28 mm Ø
320 g



HM-77-3954
30 mm Ø
340 g

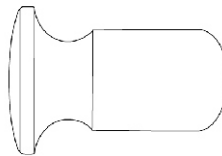


Ø 27 mm
300 g

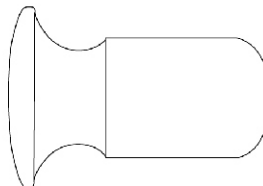
PARTSCH
HM-77-3955
18 cm/7 1/8"
with hollow handle



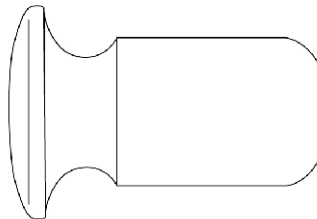
DOYEN
21 cm/8 1/4"



HM-77-3956
25 mm Ø
120 g (4 1/4 oz.)
19.5 cm/7 3/4"



HM-77-3957
30 mm Ø
180 g (6 1/2 oz.)
19.5 cm/7 3/4"



HM-77-3958
35 mm Ø
260 g (9 oz.)
21 cm/8 1/4"



with interchangeable plastic disks

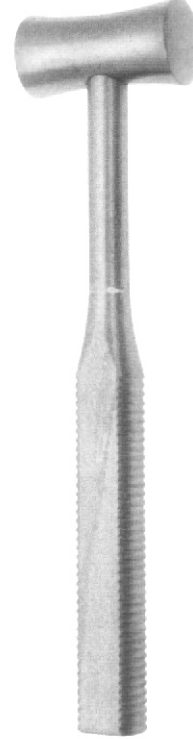
MEAD
HM-77-3959 19 cm/7 1/2"
HM-77-3960 pair of spare disks



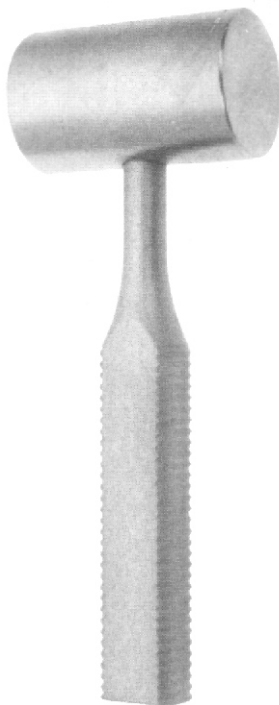
HAJEK
 HM-77-3961
 20 cm/7⁷/₈"
 200 g
 Ø 27 mm



KIRK
 HM-77-3962
 21 cm/8¹/₄"
 650 g
 Ø 38 mm



BERGMANN
 HM-77-3963
 24.5 cm/9⁵/₈"
 400 g
 Ø 30 mm

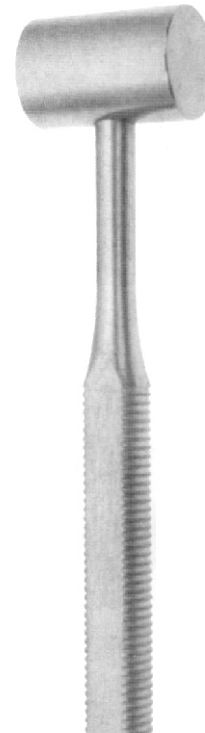


HEATH
 HM-77-3964
 18.5 cm/7¹/₄"
 700 g
 Ø 40 mm

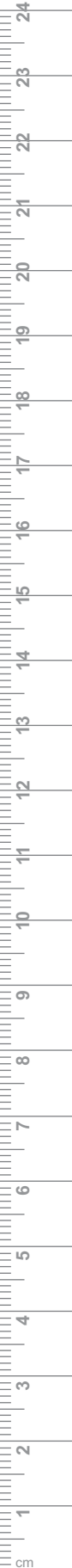


with interchangeable
 disks
 HM-77-3966

HM-77-3965
 18.5 cm/7¹/₄"
 240 g
 Ø 25 mm

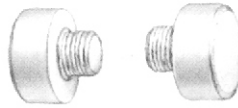


OMBREDANNE
 HM-77-3967
 24 cm/9¹/₂"
 700 g
 Ø 40 mm

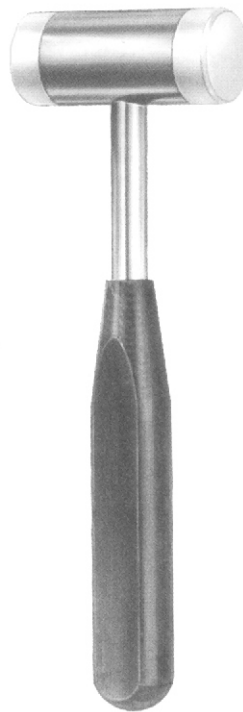




HM-77-3968
 26.5 cm/10 3/8"
 Ø 50 mm
 1300 g



HM-77-3969
 spare facings (pair)



HM-77-3970
 19 cm/7 1/2"
 Ø 25 mm
 300 g



HERBERT
HM-77-3971
 19 cm/7 1/2"
 Ø 25 mm
 215 g



MOMAD DENTAL SUPPLIES

78

- EN** Cassettes
- DE** Kassetten
- ES** Cassettes
- FR** Cassettes
- IT** cassette

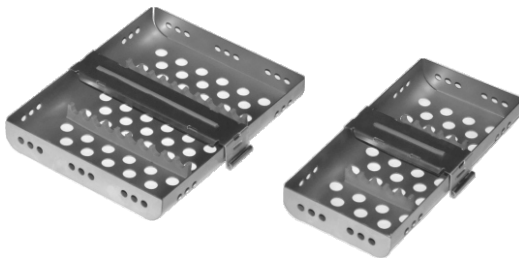
Page 207 to 210





Elongated Holes

		Dimension(mm)
HM-78-4001	05-Instruments	78 x 182 x 32
HM-78-4002	10-Instruments	142 x 182 x 32
HM-78-4003	20-Instruments	270 x 182 x 32



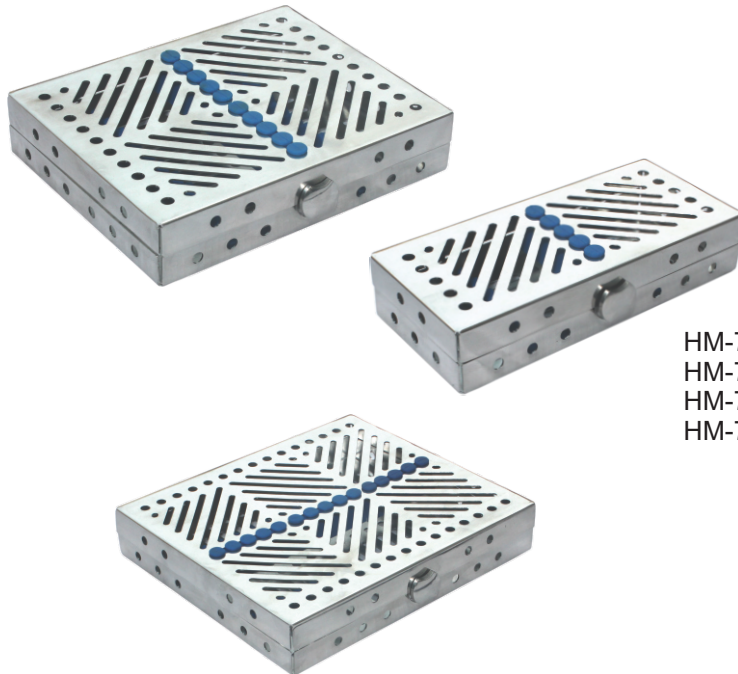
Round Bottom with Strip Lock

		Dimension(mm)
HM-78-4004	05-Instruments	90 x 182 x 25
HM-78-4005	10-Instruments	145 x 182 x 25
HM-78-4006	20-Instruments	270 x 182 x 25



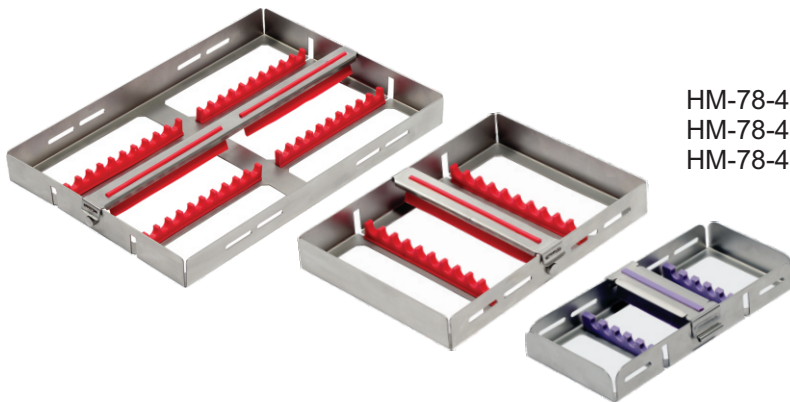
Square

		Dimension(mm)
HM-78-4007	05-Instruments	180 x 70 x 22
HM-78-4008	10-Instruments	180 x 130 x 22
HM-78-4009	20-Instruments	260 x 180 x 22



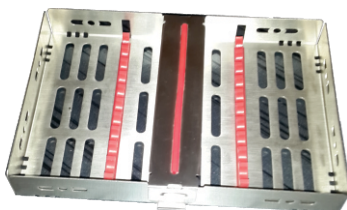
Elongated Holes

		Dimension(mm)
HM-78-4010	05-Instruments	180 x 80 x 35
HM-78-4011	10-Instruments	180 x 145 x 35
HM-78-4012	15-Instruments	210 x 180 x 35
HM-78-4013	20-Instruments	280 x 180 x 35



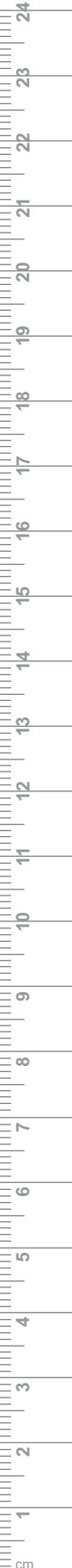
Strip Lock "H" Type

Model		Dimension(mm)
HM-78-4014	05-Instruments	180 x 80 x 25
HM-78-4015	10-Instruments	180 x 130 x 25
HM-78-4016	20-Instruments	260 x 180 x 25



Strip Lock

Model		Dimension(mm)
HM-78-4017	05-Instruments	180 x 80 x 25
HM-78-4018	10-Instruments	180 x 130 x 25
HM-78-4019	20-Instruments	260 x 180 x 25





Dimension(mm)

HM-78-4020	405 x 255 x 50
HM-78-4021	405 x 255 x 70
HM-78-4022	405 x 255 x 100



Dimension(mm)

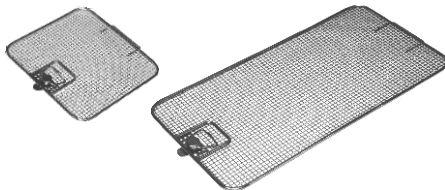
HM-78-4023	255 x 245 x 50
HM-78-4024	255 x 245 x 70
HM-78-4025	255 x 245 x 100



Dimension(mm)

HM-78-4026	255 x 120 x 50
HM-78-4027	255 x 120 x 70

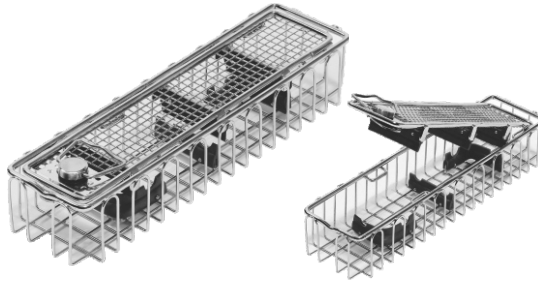
LIDs (optional)



Dimension(mm)

HM-78-4028	255 x 120
HM-78-4029	255 x 245
HM-78-4030	250 x 240
HM-78-4031	540 x 255
HM-78-4032	485 x 255
HM-78-4033	405 x 255
HM-78-4034	480 x 370
HM-78-4035	480 x 250

Endoscopic Baskets



Dimension(mm)

HM-78-4036	290 x 80 x 52
HM-78-4037	460 x 80 x 52



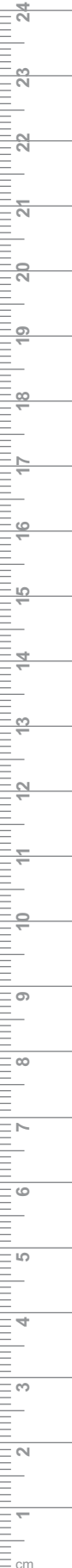
Dimension(mm)

HM-78-4038	670 x 80 x 52
HM-78-4039	700 x 80 x 52



Dimension(mm)

HM-78-4040	290 x 160 x 52
HM-78-4041	310 x 150 x 77
HM-78-4042	460 x 160 x 77
HM-78-4043	640 x 150 x 77
HM-78-4044	660 x 150 x 77
HM-78-4045	460 x 160 x 52
HM-78-4046	580 x 160 x 52



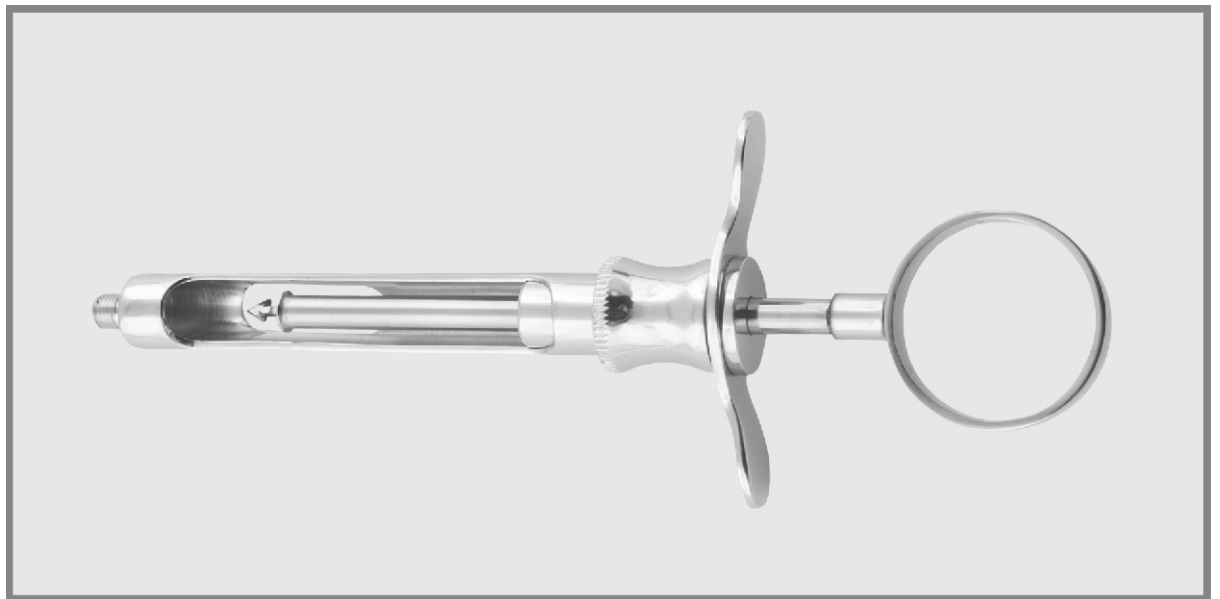


MOMAD DENTAL SUPPLIES

79

- EN** Cylinder cartidge syringe
- DE** Zylinder-Ampullenspritze
- ES** Seringue á ampoule cylindrique
- FR** Jeringo para cartucho ampollas
- IT** Siringe ampollare a cilindro

Page 211 to 216





- EN ● Cartridge syringes
- DE ● Ampullenspritzen
- ES ● Jeringas para cartucho apollas
- FR ● Lima para huesos
- IT ● Lima per ossa



HM-79-4101
 Cylinder cartridge syringe
 1.8 cc, without aspiration
 metric thread / US Thread

HM-79-4103
 Cylinder cartridge syringe
 2.2 cc, without aspiration
 metric thread / US Thread



HM-79-4102
 Cylinder cartridge syringe
 1.8 cc, with aspiration
 metric thread / US Thread

HM-79-4104
 Cylinder cartridge syringe
 2.2 cc, with aspiration
 metric thread / US Thread

HM-79-4105
 Cylinder cartridge syringe
 1.8 cc, without aspiration with
 metric thread / US Thread

HM-79-4107
 Cylinder cartridge syringe
 2.2 cc, without aspiration with
 metric thread / US Thread

HM-79-4106
 Cylinder cartridge syringe
 1.8 cc, with aspiration with
 metric thread / US Thread

HM-79-4108
 Cylinder cartridge syringe
 2.2 cc, with aspiration with
 metric thread / US Thread



HM-79-4109

Cylinder cartridge syringe
 1.8 cc, without aspiration
 metric thread / US Thread

HM-79-4111

Cylinder cartridge syringe
 2.2 cc, without aspiration
 metric thread / US Thread



HM-79-4110

Cylinder cartridge syringe
 1.8 cc, with aspiration
 metric thread / US Thread

HM-79-4112

Cylinder cartridge syringe
 2.2 cc, with aspiration
 metric thread / US Thread



HM-79-4113

Cylinder Cartridge Syringe
 1.8cc without Aspiration
 metric thread / US Thread

HM-79-4115

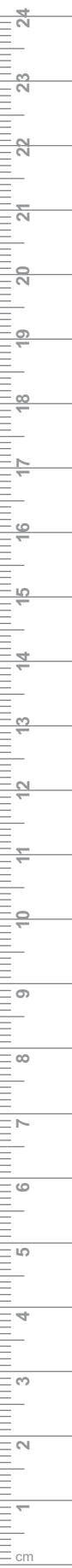
Cylinder Cartridge Syringe
 2.2cc without Aspiration
 metric thread / US Thread

HM-79-4114

Cylinder Cartridge Syringe
 1.8cc with Aspiration
 metric thread / US Thread

HM-79-4116

Cylinder Cartridge Syringe
 2.2cc with Aspiration
 metric thread / US Thread





- EN —● Cartridge syringes
- DE —● Ampullenspritzen
- ES —● Jeringas para cartucho apollas
- FR —● Lima para huesos
- IT —● Lima per ossa



HM-79-4117
 Cylinder Cartridge Syringe
 1.8cc without Aspiration
 metric thread / US Thread
 Plastic base & handle sand blast
 finish steel rod.

HM-79-4118
 Cylinder Cartridge Syringe
 1.8cc with Aspiration
 metric thread / US Thread
 Plastic base & handle sand blast
 finish steel rod.

HM-79-4119
 Cylinder Cartridge Syringe
 2.2cc without Aspiration
 metric thread / US Thread
 Plastic base & handle sand blast
 finish steel rod.

HM-79-4120
 Cylinder Cartridge Syringe
 2.2cc with Aspiration
 metric thread / US Thread
 Plastic base & handle sand blast
 finish steel rod.



HM-79-4121
 Cylinder Cartridge Syringe
 1.8cc without Aspiration
 metric thread / US Thread

HM-79-4122
 Cylinder Cartridge Syringe
 1.8cc with Aspiration
 metric thread / US Thread

HM-79-4123
 Cylinder Cartridge Syringe
 2.2cc without Aspiration
 metric thread / US Thread

HM-79-4124
 Cylinder Cartridge Syringe
 2.2cc with Aspiration
 metric thread / US Thread



HM-79-4125
 Cylinder Cartridge Syringe
 1.8cc without Aspiration
 metric thread / US Thread

HM-79-4127
 Cylinder Cartridge Syringe
 2.2cc without Aspiration
 metric thread / US Thread

HM-79-4126
 Cylinder Cartridge Syringe
 1.8cc with Aspiration
 metric thread / US Thread

HM-79-4128
 Cylinder Cartridge Syringe
 2.2cc with Aspiration
 metric thread / US Thread

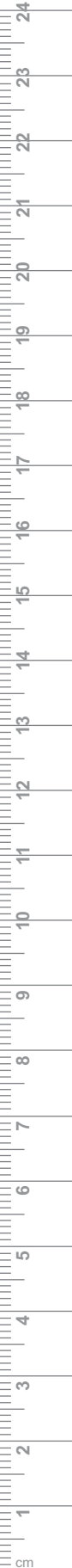


HM-79-4129
 Cylinder Cartridge Syringe
 1.8cc without Aspiration
 metric thread / US Thread

HM-79-4131
 Cylinder Cartridge Syringe
 2.2cc without Aspiration
 metric thread / US Thread

HM-79-4130
 Cylinder Cartridge Syringe
 1.8cc with Aspiration
 metric thread / US Thread

HM-79-4132
 Cylinder Cartridge Syringe
 2.2cc with Aspiration
 metric thread / US Thread





- EN —● Cartridge syringes
- DE —● Ampullenspritzen
- ES —● Jeringas para cartucho apollas
- FR —● Lima para huesos
- IT —● Lima per ossa



HM-79-4133
 Cylinder Cartridge Syringe
 1.8cc without Aspiration
 metric thread / US Thread

HM-79-4134
 Cylinder Cartridge Syringe
 1.8cc with Aspiration
 metric thread / US Thread

HM-79-4135
 Cylinder Cartridge Syringe
 2.2cc without Aspiration
 metric thread / US Thread

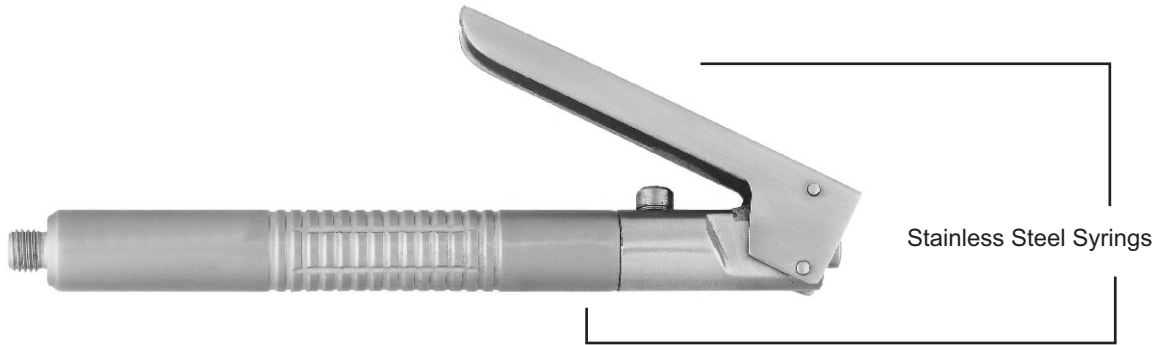
HM-79-4136
 Cylinder Cartridge Syringe
 2.2cc with Aspiration
 metric thread / US Thread



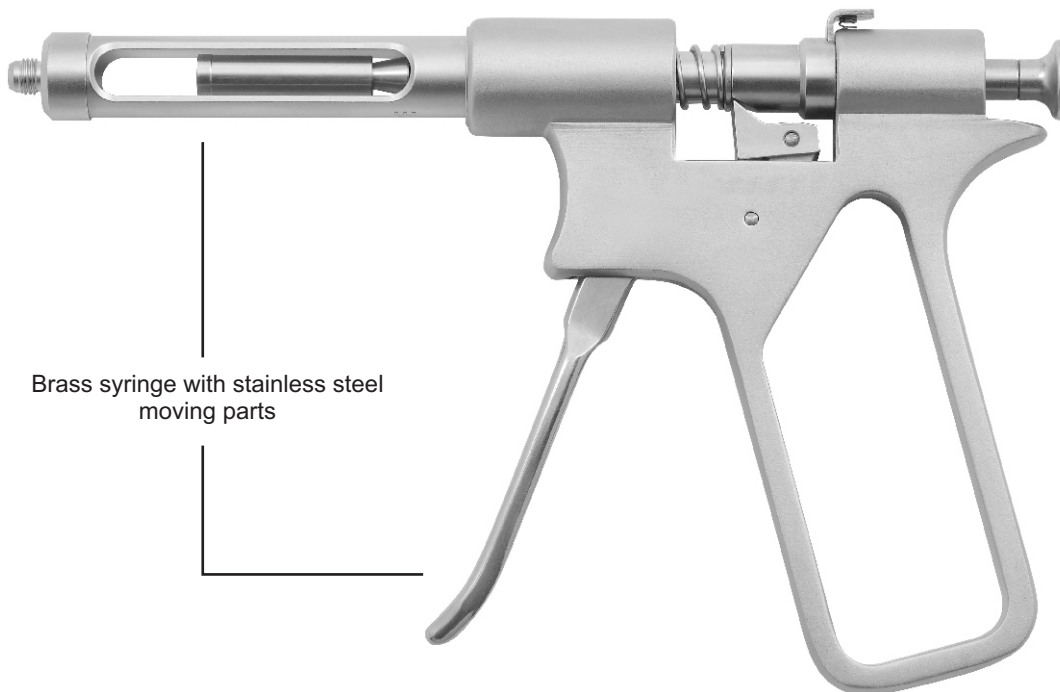
HM-79-4137
 Aspirating Syringe
 1.8cc with fix tip, S/S
 metric thread / US Thread

HM-79-4138
 Aspirating Syringe
 2.2cc with fix tip, S/S
 metric thread / US Thread

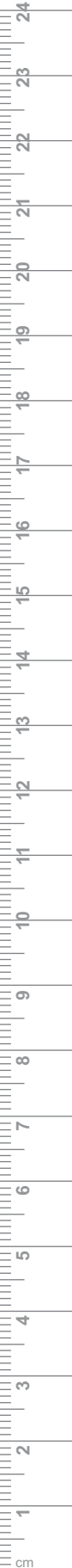
Intra-Ligamentale Syringes



HM-79-4139
 1.8 cc metric thread / US Thread
 2.2 cc metric thread / US Thread



HM-79-4140
 1.8 cc metric thread / US Thread
 2.2 cc metric thread / US Thread



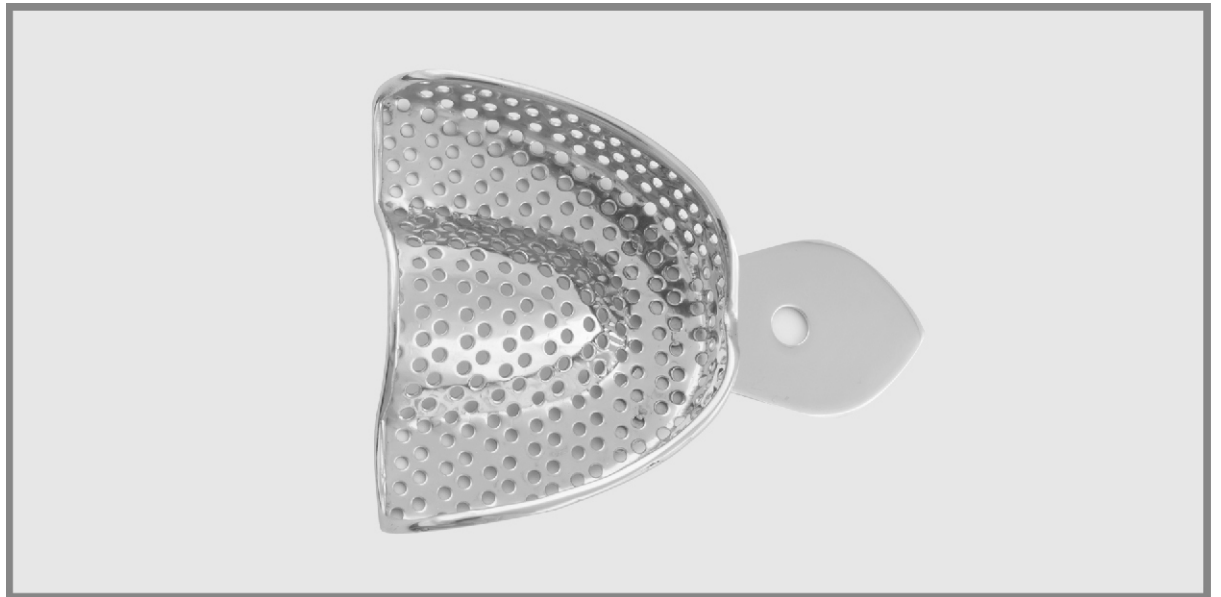


MOMAD DENTAL SUPPLIES

80

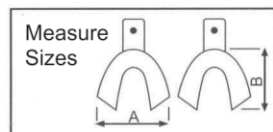
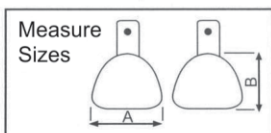
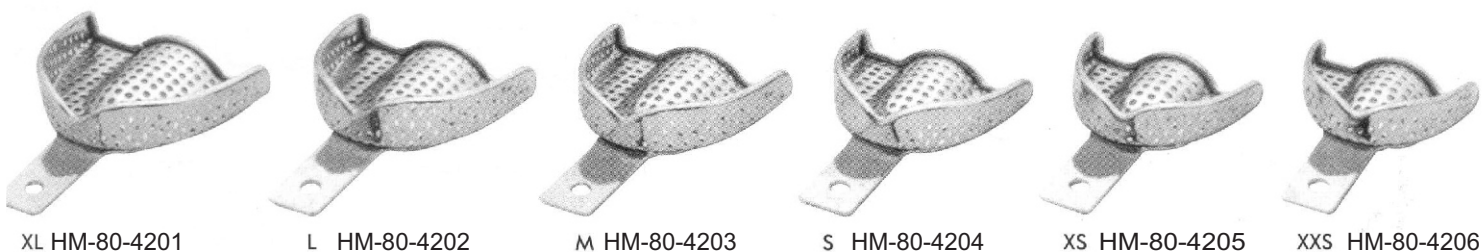
- EN** Impression Trays
- DE** Abdrucklöffel
- ES** Porte empreintes
- FR** Cubetas para impresiones
- IT** Portaimpronte

Page 217 to 228



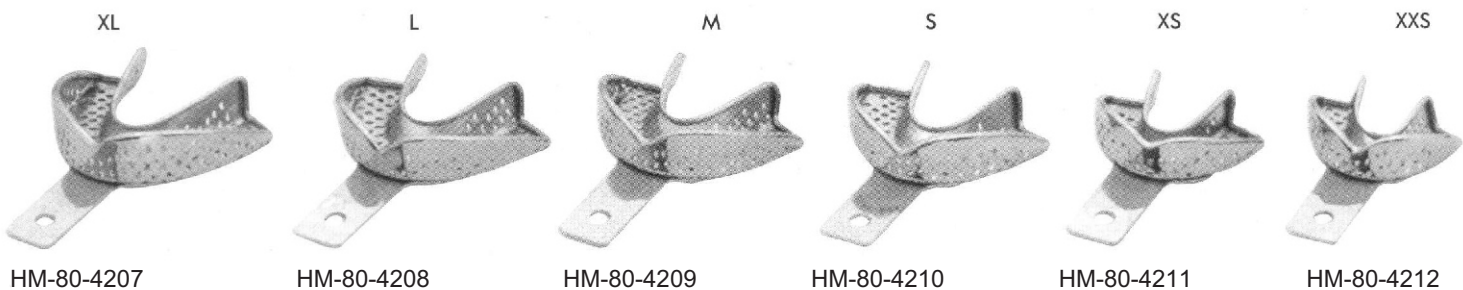


- EN —● Impression Trays Perforated with Rim Lock
- DE —● Abdrucklöffel perforiert mit Rim Lock
- ES —● Bandejas de impresión perforadas con borde de bloqueo
- FR —● Plateaux d'empreinte perforés avec verrouillage de la jante
- IT —● Vassoio per impronta perforati con Cerchione

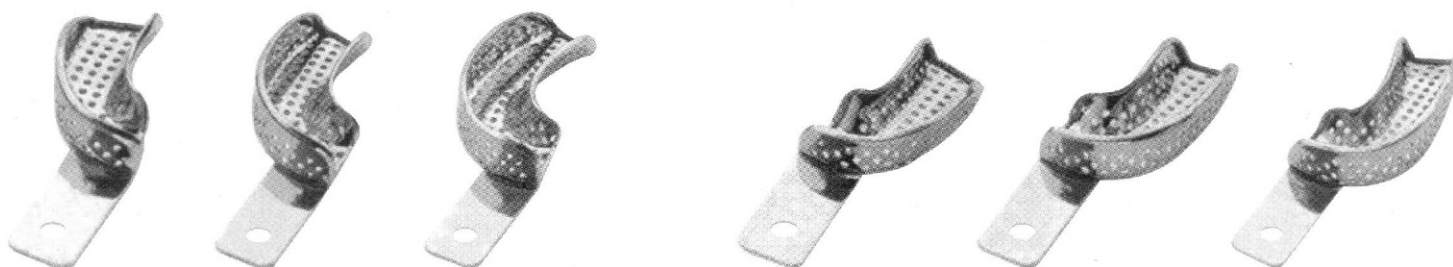


Upper		A (left-right)	B (top-bottom)
80-4201	XL	81 mm	63 mm
80-4202	L	73 mm	58 mm
80-4203	M	71 mm	52 mm
80-4204	S	67 mm	53 mm
80-4205	XS	65 mm	51 mm
80-4206	XXS	61 mm	50 mm

Lower		A (left-right)	B (top-bottom)
80-4207	XL	78 mm	63 mm
80-4208	L	74 mm	62 mm
80-4209	M	72 mm	59 mm
80-4210	S	70 mm	57 mm
80-4211	XS	69 mm	55 mm
80-4212	XXS	59 mm	50 mm



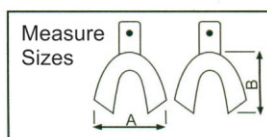
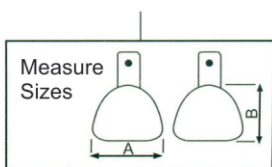
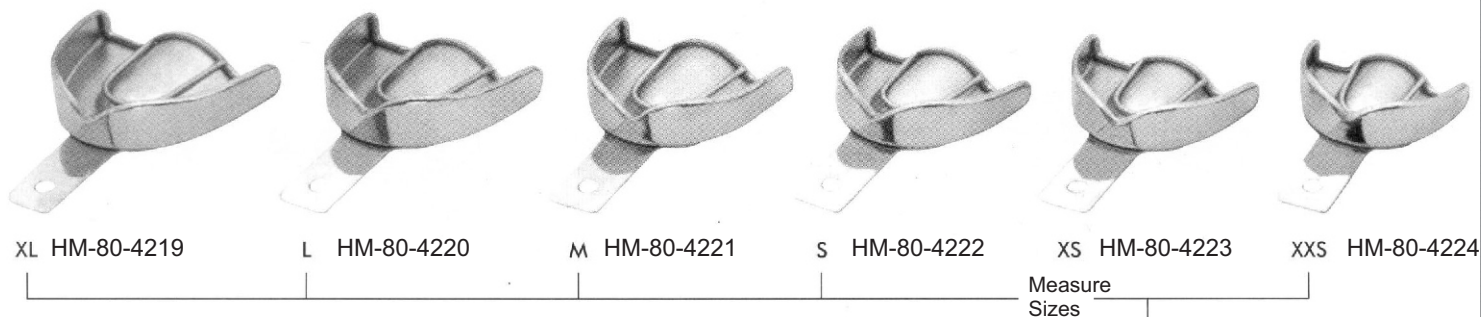
HM-80-4207 HM-80-4208 HM-80-4209 HM-80-4210 HM-80-4211 HM-80-4212



HM-80-4213 HM-80-4214 HM-80-4215 HM-80-4216 HM-80-4217 HM-80-4218

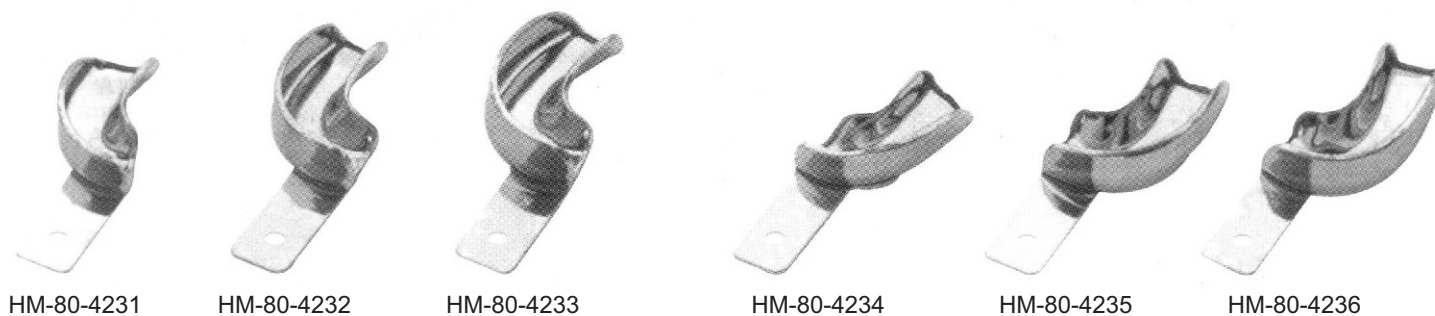
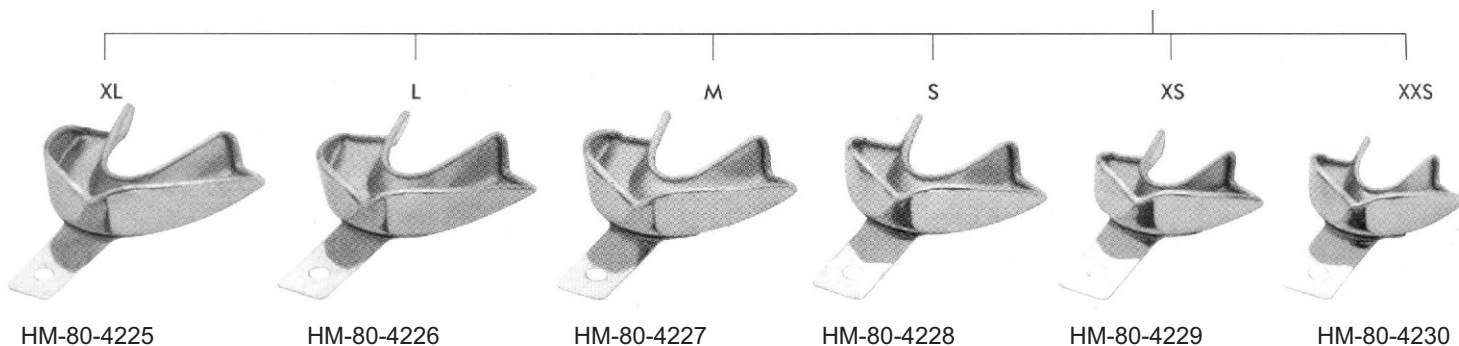
Impression Trays Perforated with Rim Lock
 Abdrucklöffel perforiert mit Rim Lock
 Bandejas de impresión perforadas con borde de bloqueo
 Plateaux d'empreinte perforés avec verrouillage de la jante
 Vassoi per impronta perforati con Cerchione

- EN
- DE
- ES
- FR
- IT



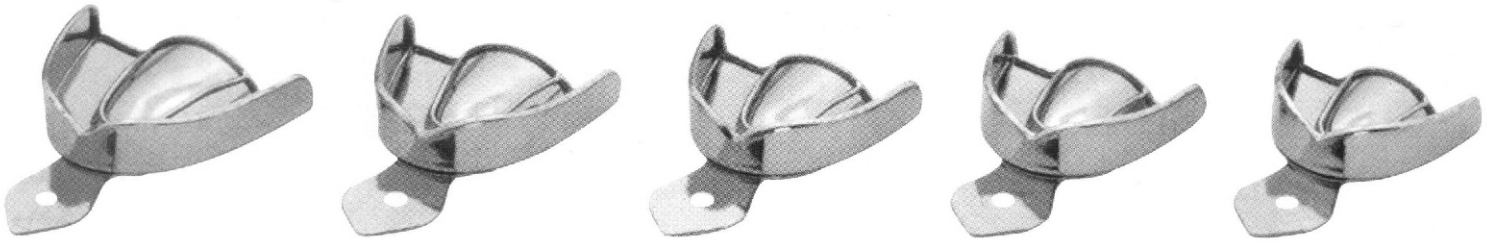
Upper		A (left-right)	B (top-bottom)
81-4219	XL	81 mm	63 mm
81-4220	L	73 mm	58 mm
81-4221	M	71 mm	52 mm
81-4222	S	67 mm	53 mm
81-4223	XS	65 mm	51 mm
81-4224	XXS	61 mm	50 mm

Lower		A (left-right)	B (top-bottom)
81-4225	XL	78 mm	63 mm
81-4226	L	74 mm	62 mm
81-4227	M	72 mm	59 mm
81-4228	S	70 mm	57 mm
81-4229	XS	69 mm	55 mm
81-4201	XXS	59 mm	50 mm





- EN —● Impression Trays Perforated with Rim Lock
- DE —● Abdrucklöffel perforiert mit Rim Lock
- ES —● Bandejas de impresión perforadas con borde de bloqueo
- FR —● Plateaux d'empreinte perforés avec verrouillage de la jante
- IT —● Vassoi per impronta perforati con Cerchione



HM-80-4237

HM-80-4238

HM-80-4239

HM-80-4240

HM-80-4241

XL

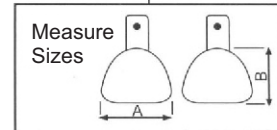
L

M

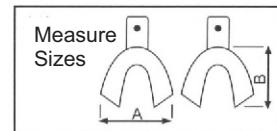
S

XS

Upper		A (left-right)	B (top-bottom)
HM-80-4237	XL	81 mm	63 mm
HM-80-4238	L	73 mm	58 mm
HM-80-4239	M	71 mm	52 mm
HM-80-4240	S	67 mm	53 mm
HM-80-4241	XS	65 mm	51 mm



Lower		A (left-right)	B (top-bottom)
HM-80-4242	XL	78 mm	63 mm
HM-80-4243	L	74 mm	62 mm
HM-80-4244	M	72 mm	59 mm
HM-80-4245	S	70 mm	57 mm
HM-80-4246	XS	69 mm	55 mm



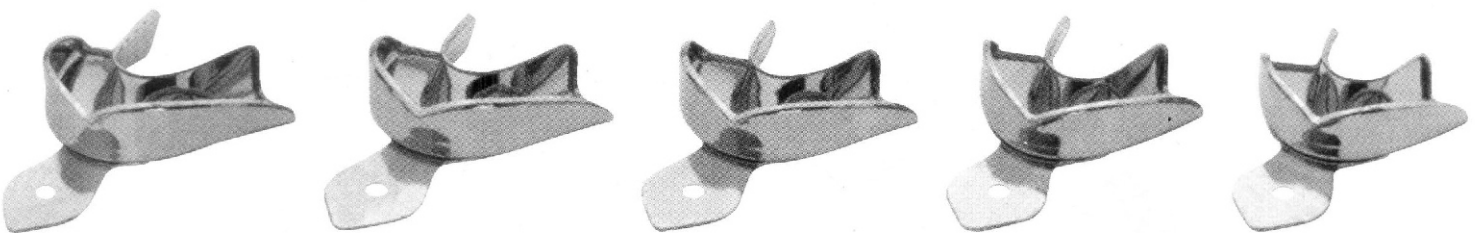
XL

L

M

S

XS



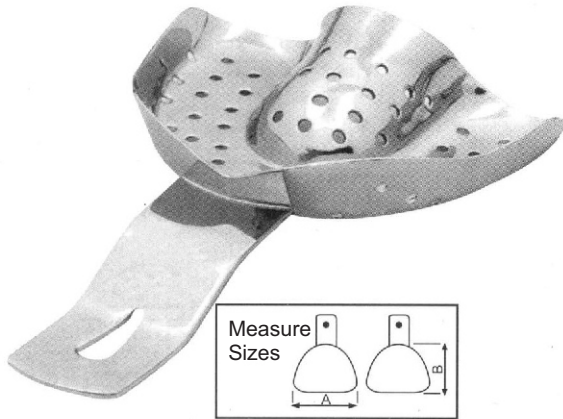
HM-80-4242

HM-80-4243

HM-80-4244

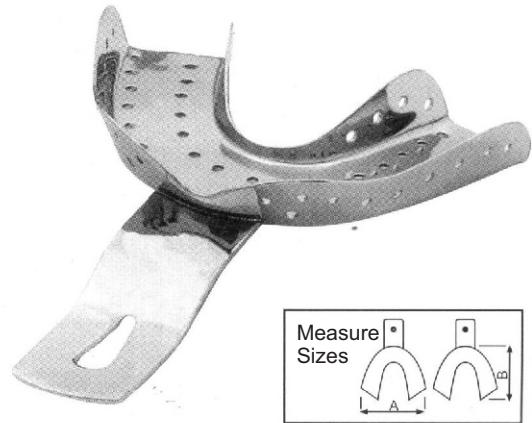
HM-80-4245

HM-80-4246



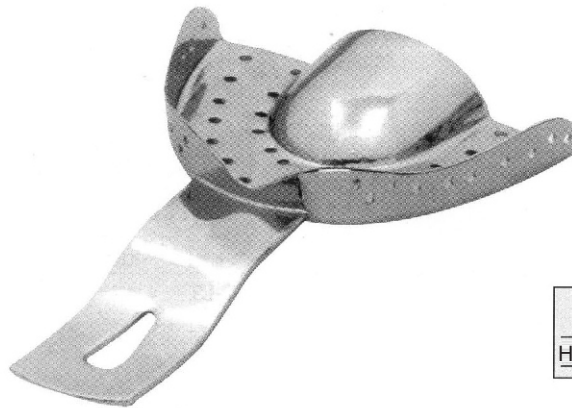
For Toothed Upper Jaws
 (Fig. 0 for children)

	A mm.	B mm.
HM-80-4247 0	59	52
HM-80-4248 1	66	52
HM-80-4249 2	71	62
HM-80-4250 3	71	64
HM-80-4251 4	80	70



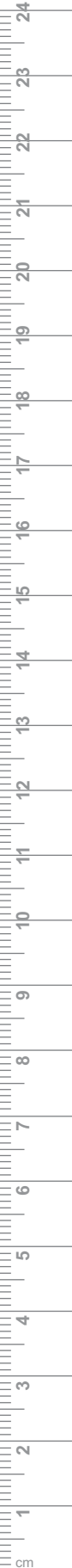
For Toothed Lower Jaws
 (Fig. 0 for children)

	A mm.	B mm.
HM-80-4252 0	65	46
HM-80-4253 1	67	50
HM-80-4254 2	76	54
HM-80-4255 3	79	56
HM-80-4256 4	79	61



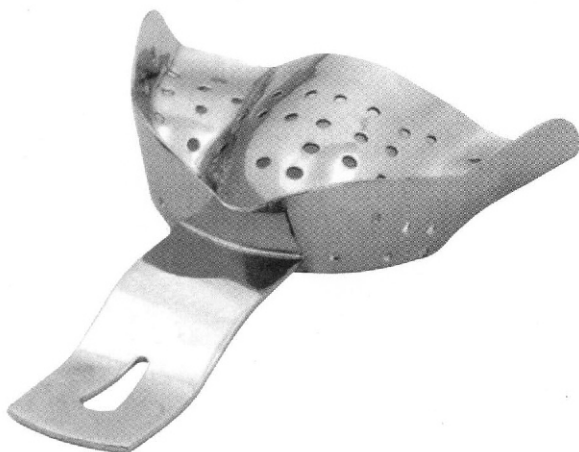
For Narrow Toothed Upper Jaws

	A mm.	B mm.
HM-80-4257 2	70	54



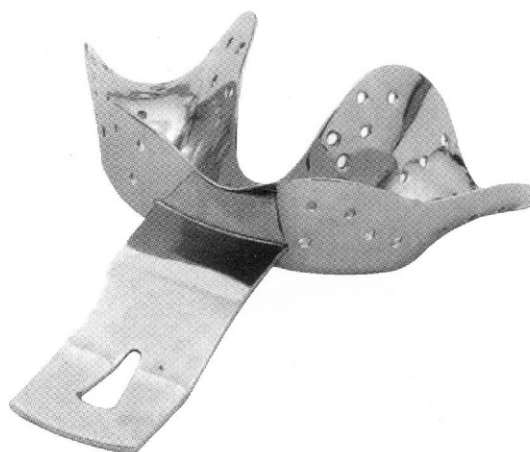
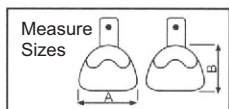


- EN —● Impression Trays Perforated with Rim Lock
- DE —● Abdrucklöffel perforiert mit Rim Lock
- ES —● Bandejas de impresión perforadas con borde de bloqueo
- FR —● Plateaux d'empreinte perforés avec verrouillage de la jante
- IT —● Vassoio per impronta perforati con Cerchione



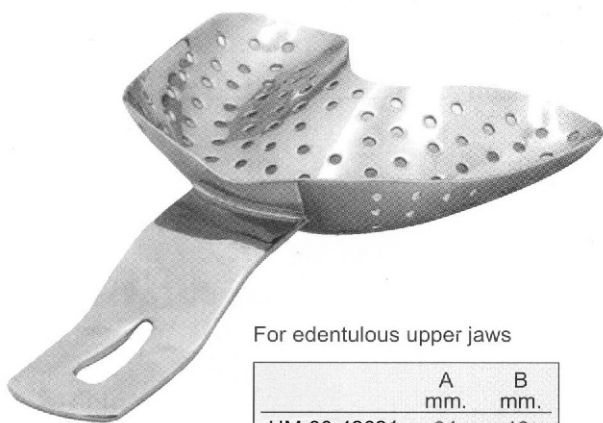
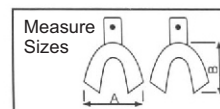
For partially toothed upper jaws

	A mm.	B mm.
HM-80-4258 1	62	50
HM-80-42592	70	56



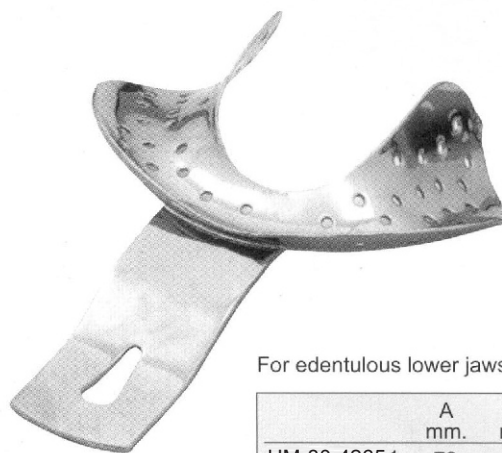
For partially toothed lower jaws

	A mm.	B mm.
HM-80-42601	70	55
HM-80-42612	78	59



For edentulous upper jaws

	A mm.	B mm.
HM-80-42621	64	46
HM-80-42632	68	53
HM-80-42643	79	61



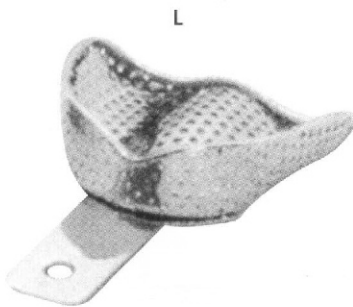
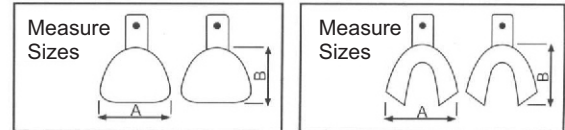
For edentulous lower jaws

	A mm.	B mm.
HM-80-42651	70	48
HM-80-42662	70	53
HM-80-4267 3	72	57

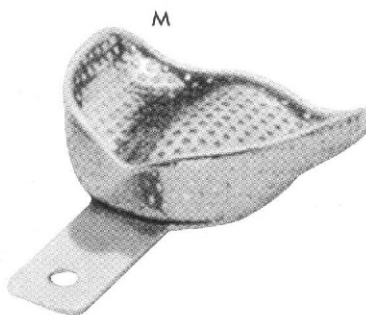




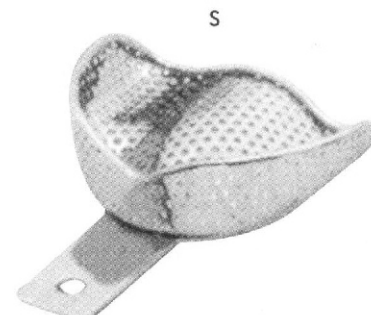
Solid stainless steel anterior depressed impression trays with retention rim.



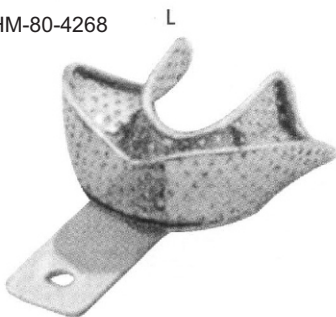
HM-80-4268



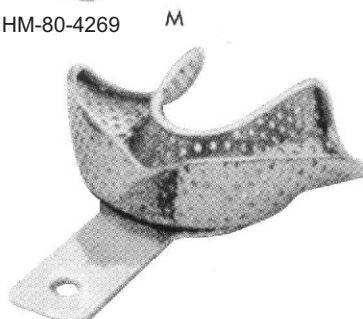
HM-80-4269



HM-80-4270



HM-80-4271



HM-80-4272



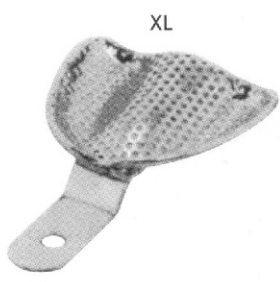
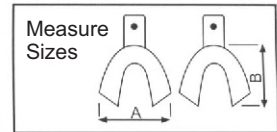
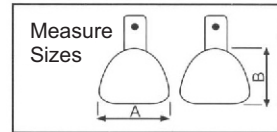
HM-80-4273

	A	B
	mm.	mm.
HM-80-4268 L	81	67
HM-80-4269 M	71	64
HM-80-4270 S	70	57

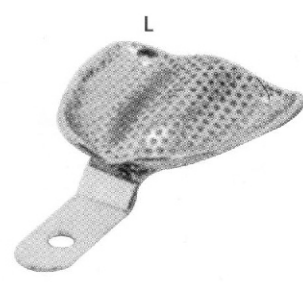
	A	B
	mm.	mm.
HM-80-4271 L	81	60
HM-80-4272 M	79	57
HM-80-4273 S	76	54



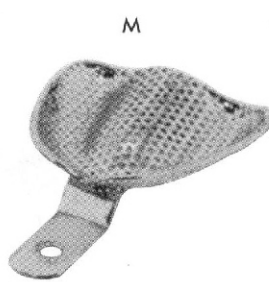
Solid total denture stainless steel impression trays with rim.



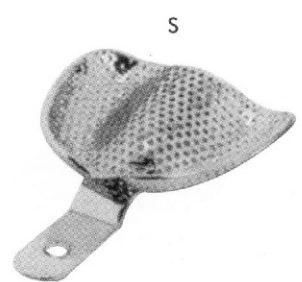
HM-80-4274



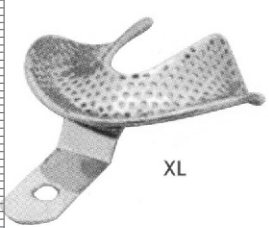
HM-80-4275



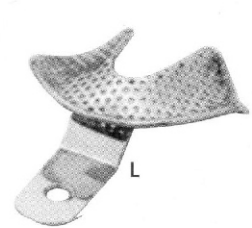
HM-80-4276



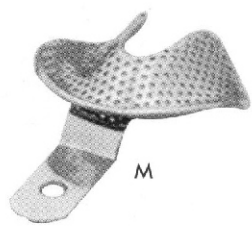
HM-80-4277



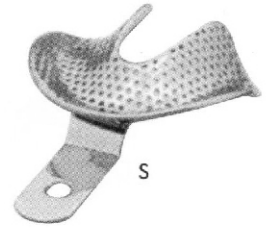
HM-80-4278



HM-80-4279



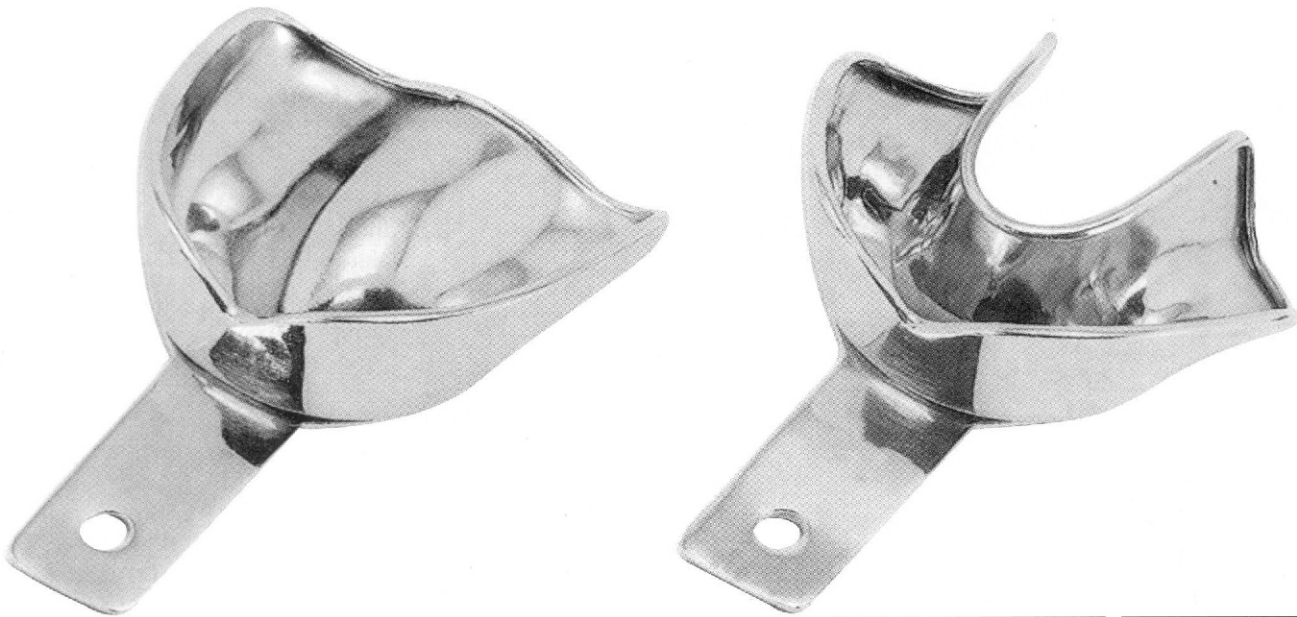
HM-80-4280



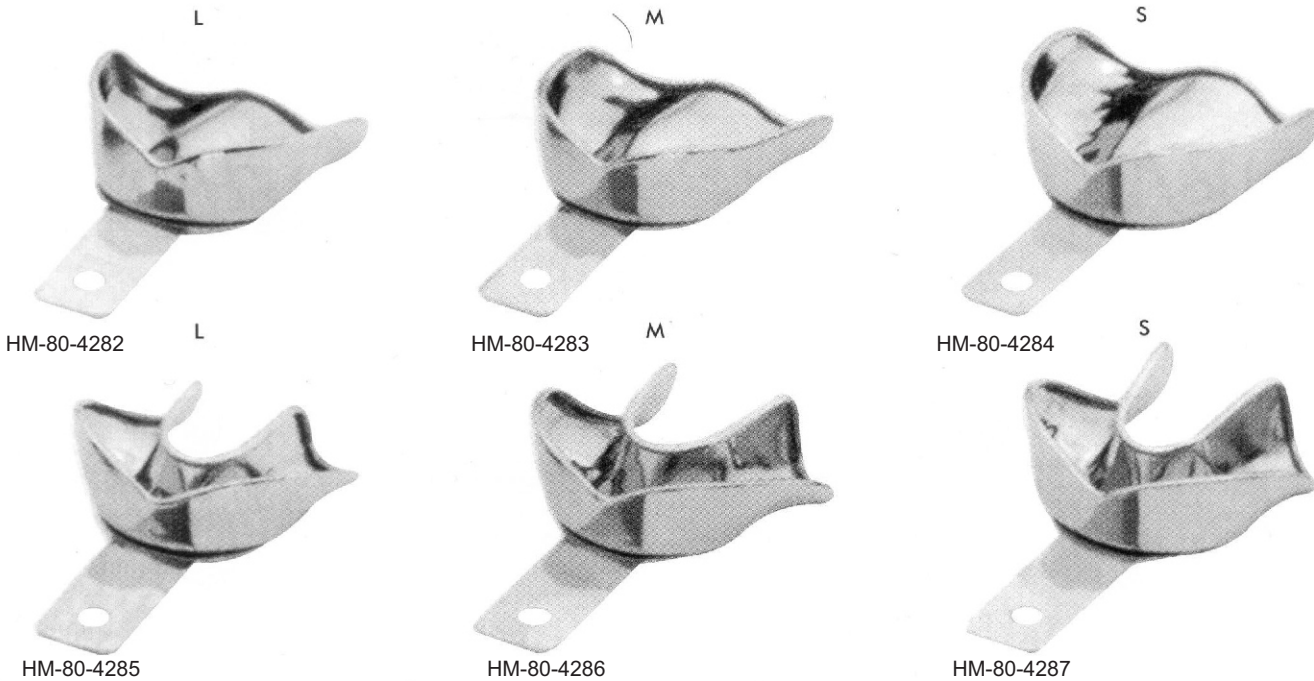
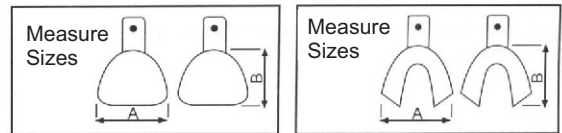
HM-80-4281

	A mm.	B mm.
HM-80-4274 XL	79	70
HM-80-4275 L	76	67
HM-80-4276 M	70	64
HM-80-4277 S	73	60

	A mm.	B mm.
HM-80-4278 XL	86	64
HM-80-4279 L	70	64
HM-80-4280 M	73	60
HM-80-4281 S	70	57



Solid stainless steel anterior depressed impression trays with retention rim.



HM-80-4282

HM-80-4283

HM-80-4284

HM-80-4285

HM-80-4286

HM-80-4287

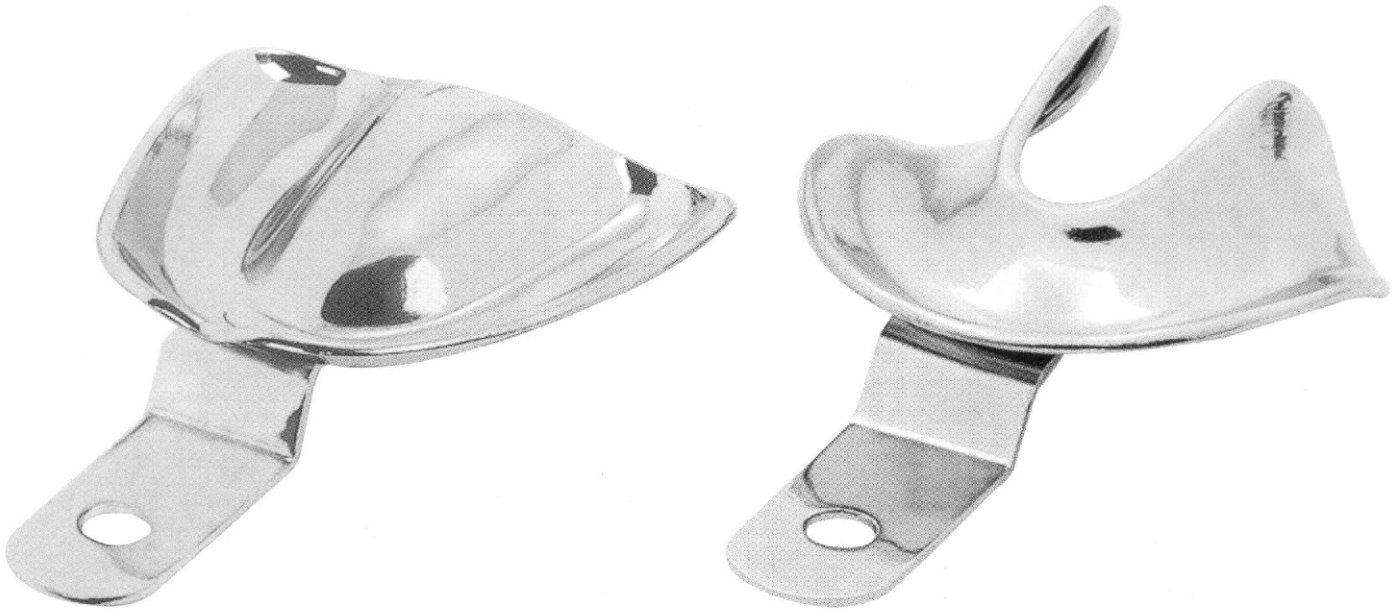
	A mm.	B mm.
HM-80-4282	81	67
HM-80-4283	71	64
HM-80-4284	70	57

	A mm.	B mm.
HM-80-4285 L	81	60
HM-80-4286 M	79	57
HM-80-4287 S	76	54

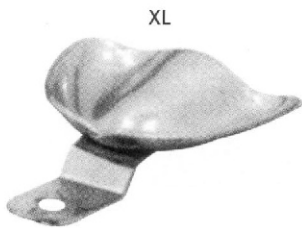
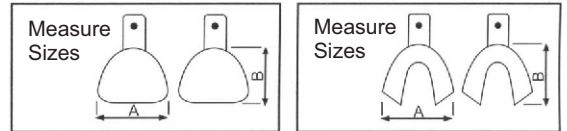


- EN —● Impression Trays Solid Full Denture
- DE —● Abdrucklöffel Solid Full Denture
- ES —● Bandejas de impresión Solid Full Denture
- FR —● Impression Trays pleine prothèse complète
- IT —● Impressione vassoi piena protesi totale

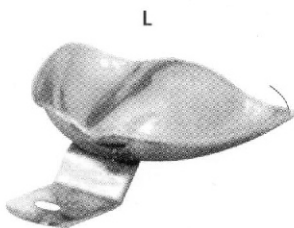
MOMAD DENTAL SUPPLIES



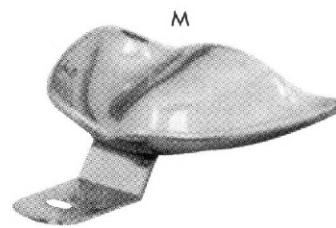
Solid total denture stainless steel impression trays with rim.



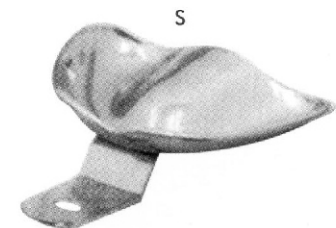
HM-80-4288



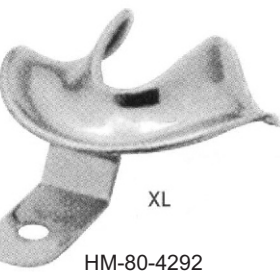
HM-80-4289



HM-80-4290



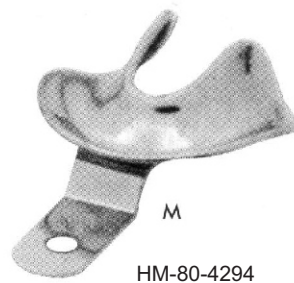
HM-80-4291



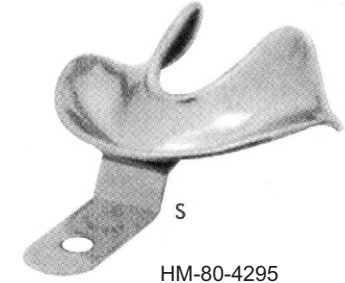
HM-80-4292



HM-80-4293



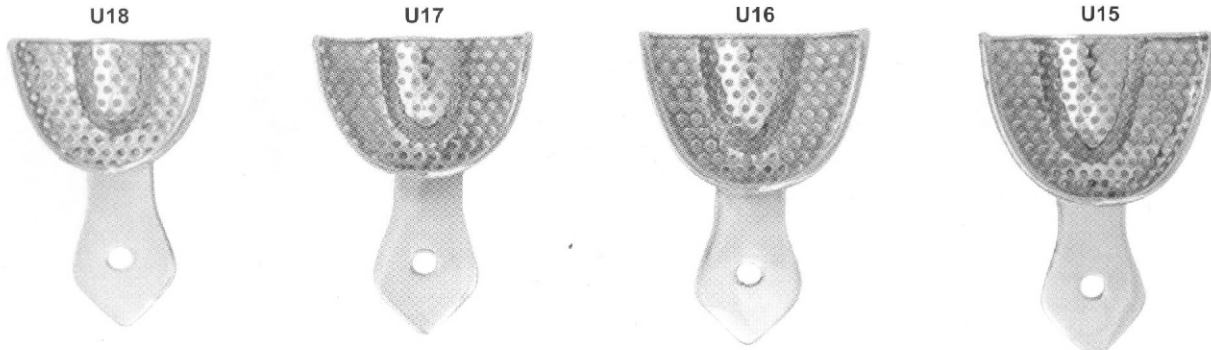
HM-80-4294



HM-80-4295

	A mm.	B mm.
HM-80-4288XL	79	70
HM-80-4289L	76	67
HM-80-4290M	70	64
HM-80-4291S	73	60

	A mm.	B mm.
HM-80-4292 XL	86	64
HM-80-4293 L	70	64
HM-80-4294 M	73	60
HM-80-4295 S	70	57



HM-80-4296

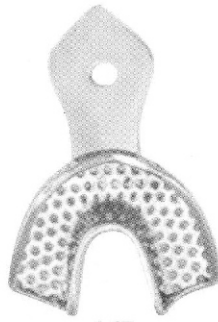
HM-80-4297

HM-80-4298

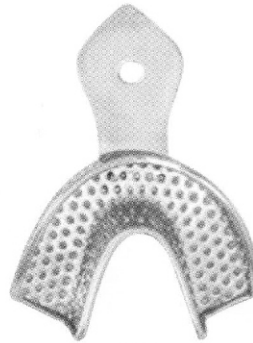
HM-80-4299



L18
HM-80-4300



L17
HM-80-4301



L16
HM-80-4302



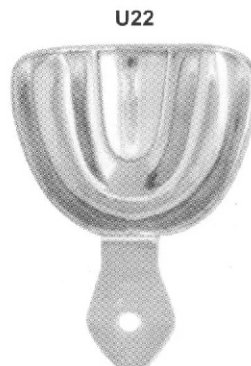
L15
HM-80-4303



HM-80-4304



HM-80-4305



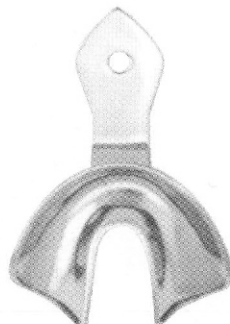
HM-80-4306



HM-80-4307



L24
HM-80-4308



L23
HM-80-4309



L22
HM-80-4310



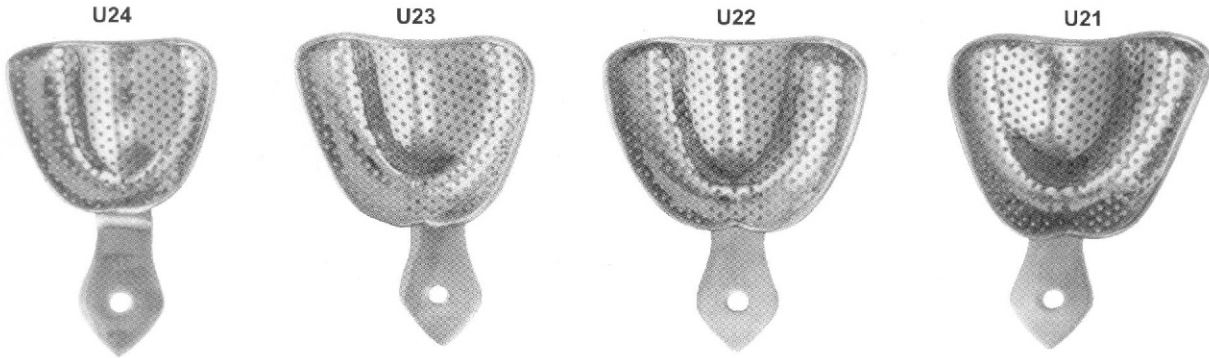
L21
HM-80-4311





- EN —● Impression Trays
- DE —● Knochenfeilen
- ES —● Limes à os
- FR —● Plateaux d'impression
- IT —● Vassoi per le impressioni

MOMAD DENTAL SUPPLIES



HM-80-4312 HM-80-4313 HM-80-4314 HM-80-4315



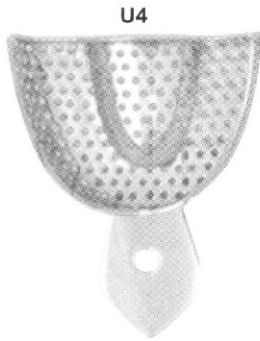
HM-80-4316 HM-80-4317 HM-80-4318 HM-80-4319



HM-80-4320 HM-80-4321 HM-80-4322

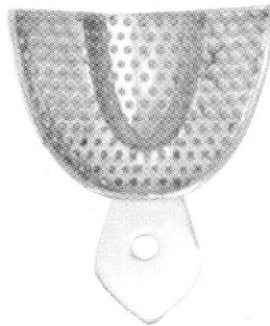


HM-80-4323 HM-80-4324 HM-80-4325



U4

HM-80-4326



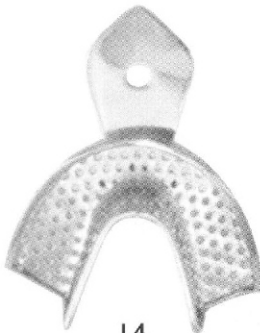
U3

HM-80-4327



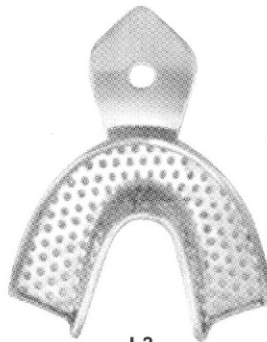
U2

HM-80-4328



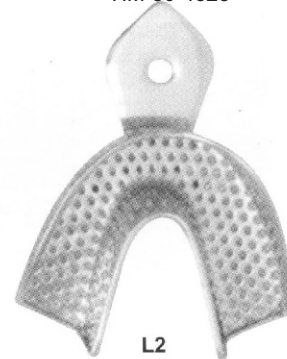
L4

HM-80-4329



L3

HM-80-4330



L2

HM-80-4331



U15

HM-80-4332



U16

HM-80-4333



U17

HM-80-4334



U18

HM-80-4335



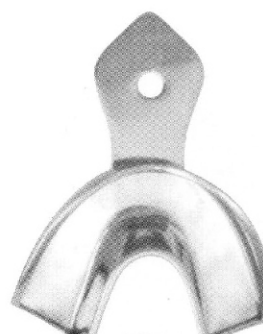
L15

HM-80-4336



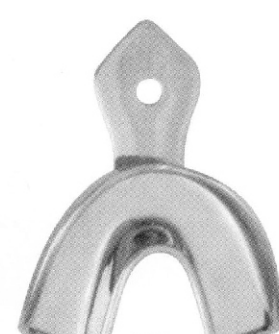
L16

HM-80-4337



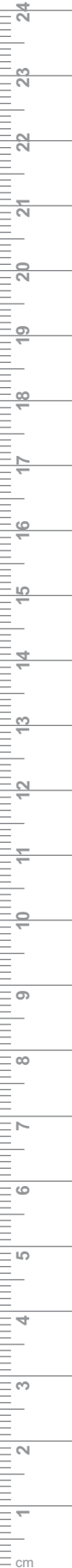
L17

HM-80-4338



L18

HM-80-4339





MOMAD DENTAL SUPPLIES

81

EN	Articulators
DE	Artikulatoren
ES	Articuladores
FR	Articulateurs
IT	articolatori

Page 229 to 230





HM-81-4301



HM-81-4302



HM-81-4303



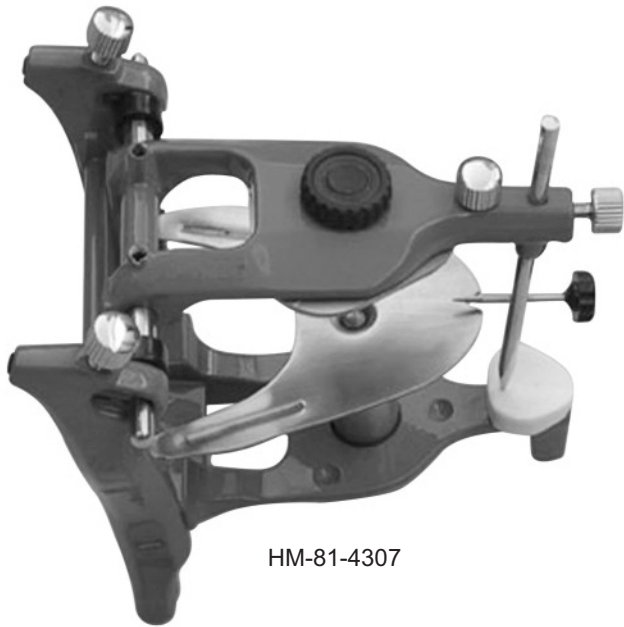
HM-81-4304



HM-81-4306



HM-81-4305



HM-81-4307



HM-81-4308



HM-81-4309



HM-81-4310



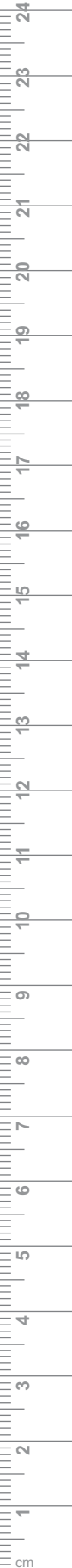
HM-81-4312



HM-81-4311



HM-81-4313





MOMAD DENTAL SUPPLIES

82

EN	Holloware
DE	Holloware
ES	holloware
FR	Platerie
IT	Holloware

Page 231 to 234





- EN —●— Hollowware
- DE —●— Hohlkörper
- ES —●— Hollowware
- FR —●— Hollowware
- IT —●— cavo



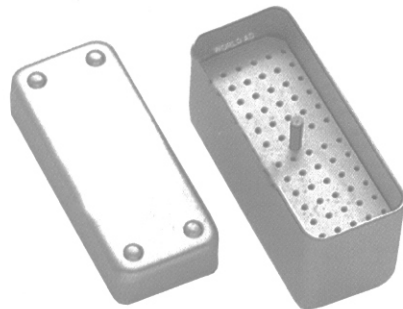
Needle Case Round with Cover
HM-82-4401 65x15mm



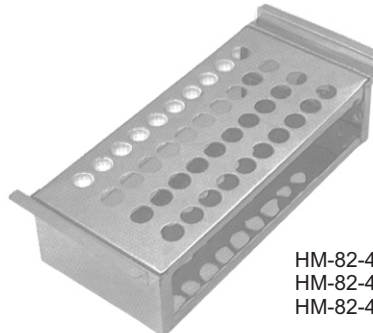
Needle Case Round
HM-82-4402 80x20mm



Needle Case Rectangle
HM-82-4403 70x70x10mm

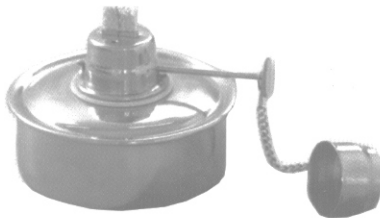


Endodontic Box
HM-82-4404
100x40x50mm

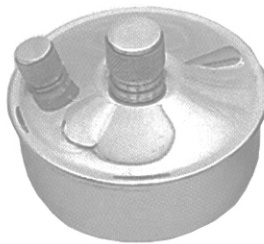


Tube Rack

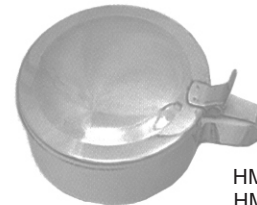
- HM-82-4405 6.35x15.25x5cm for 12 tubes
- HM-82-4406 6.35x17.75x7.5cm for 27 tubes
- HM-82-4407 7.50x17.75x6.35cm for 36 tubes



Sprit Lamp
HM-82-4408
Standard Size



Sprit Lamp
HM-82-4409
Standard Size



Sputum Cup

- HM-82-4410 75x80mm
- HM-82-4411 100x50mm
- HM-82-4412 100x80mm



Dressing Jar

- | | | |
|------------|-----------|------------|
| HM-82-4413 | 80x60mm | HM-82-4420 |
| HM-82-4414 | 80x80mm | HM-82-4421 |
| HM-82-4415 | 100x100mm | HM-82-4423 |
| HM-82-4416 | 120x120mm | HM-82-4424 |
| HM-82-4417 | 150x150mm | HM-82-4425 |
| HM-82-4418 | 180x180mm | HM-82-4426 |
| HM-82-4419 | 200x200mm | HM-82-4427 |



Dressing Jar



Fennle

- HM-82-4428 100mm Ø
- HM-82-4429 120mm Ø
- HM-82-4430 150mm Ø
- HM-82-4431 200mm Ø



Cotton Holder
HM-82-4432



Cotton Holder
HM-82-4433





Forceps Jar

- HM-82-4434 30x90mm
- HM-82-4435 50x125mm
- HM-82-4436 50x170mm
- HM-82-4437 50x200mm
- HM-82-4438 40x230mm
- HM-82-4439 70x110mm
- HM-82-4440 80x150mm
- HM-82-4441 100x200mm
- HM-82-4442 150x30mm



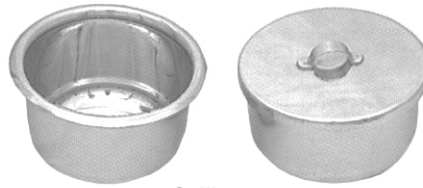
Medicine Cup

- HM-82-4461 50ml
- HM-82-4462 60ml
- HM-82-4463 70ml



Kick Bucket with Trolley

- 30-6819-01
- 390x280x180mm



Gallipot

- | | |
|------------------|------------------|
| HM-82-4443 01 oz | HM-82-4450 09 oz |
| HM-82-4444 02 oz | HM-82-4451 10 oz |
| HM-82-4445 03 oz | HM-82-4452 11 oz |
| HM-82-4446 04 oz | HM-82-4453 12 oz |
| HM-82-4447 05 oz | HM-82-4454 13 oz |
| HM-82-4448 06 oz | HM-82-4455 14 oz |
| HM-82-4448 07 oz | HM-82-4456 15 oz |
| HM-82-4449 08 oz | HM-82-4457 16 oz |



Sponge Bowl

- HM-82-4458 12 cm
- HM-82-4459 15 cm
- HM-82-4460 20 cm



Lotion Bowl without spout

- | | |
|---------------------|----------------------|
| HM-82-4464 40x19mm | HM-82-4471 150x65mm |
| HM-82-4465 50x25mm | HM-82-4472 180x85mm |
| HM-82-4466 60x30mm | HM-82-4473 200x100mm |
| HM-82-4467 80x40mm | HM-82-4474 250x120mm |
| HM-82-4468 100x50mm | HM-82-4475-12 300mm |
| HM-82-4469 120x60mm | HM-82-4476-13 350mm |
| HM-82-4470 140x60mm | HM-82-4477-14 400mm |



Wash Basin

- HM-82-4478 300x80mm
- HM-82-4479 320x85mm
- HM-82-4480 330x90mm
- HM-82-4481 350x110mm
- HM-82-4482 400x115mm



Kidney Tray

- HM-82-4486 12cm
- HM-82-4487 15cm
- HM-82-4488 18cm
- HM-82-4489 20cm
- HM-82-4490 25cm
- HM-82-4491 28cm
- HM-82-4492 30cm



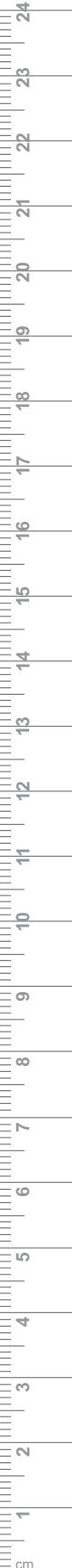
Kidney Tray Shallow

- HM-82-4483 17cm
- HM-82-4484 22cm
- HM-82-4485 24cm



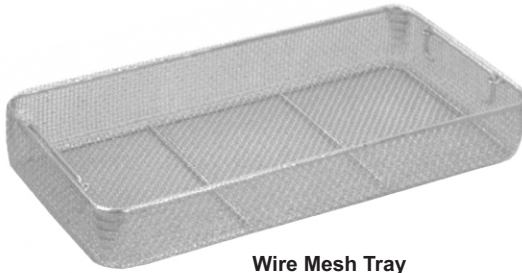
Kidney Tray (with cover)

- HM-82-4493 15cm
- HM-82-4494 20cm
- HM-82-4495 25cm
- HM-82-4496 30cm

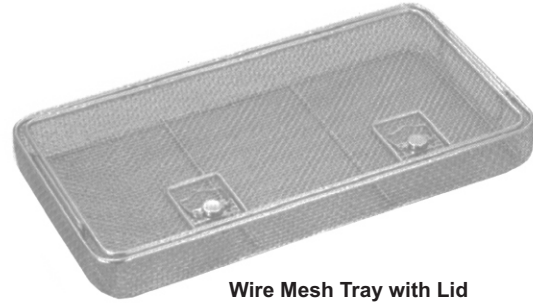




EN — Hollowware
 DE — Hohlkörper
 ES — Hollowware
 FR — Hollowware
 IT — cavo



Wire Mesh Tray
 HM-82-4497 240x250x5mm
 HM-82-4498 480x250x5mm
 HM-82-4499 550x250x5mm
 HM-82-4500 240x250x7mm
 HM-82-4501 480x250x7mm
 HM-82-4502 240x250x10mm
 HM-82-4503 480x250x10mm



Wire Mesh Tray with Lid
 HM-82-4504 240x250x5mm
 HM-82-4505 480x250x5mm
 HM-82-4506 550x250x5mm
 HM-82-4507 240x250x7mm
 HM-82-4508 480x250x7mm
 HM-82-4509 240x250x10mm
 HM-82-4510 480x250x10mm



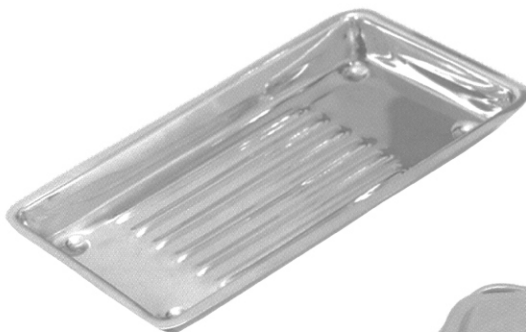
Perforated Tray
 HM-82-4511 200x100x40mm
 HM-82-4512 250x120x50mm
 HM-82-4513 300x150x50mm
 HM-82-4514 350x170x50mm
 HM-82-4515 400x200x50mm



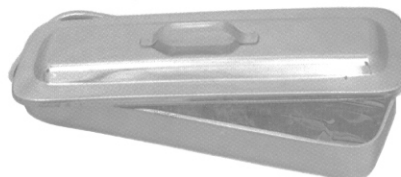
Instruments Tray without Lid
 HM-82-4516 100x150x25mm
 HM-82-4517 150x200x40mm
 HM-82-4518 200x250x45mm
 HM-82-4519 250x300x50mm
 HM-82-4520 300x350x50mm
 HM-82-4521 150x300x50mm
 HM-82-4522 200x300x50mm
 HM-82-4523 230x150x50mm



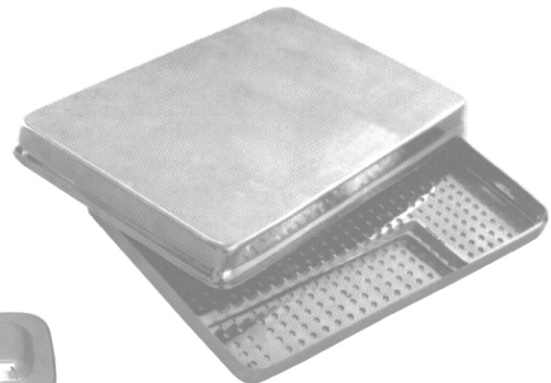
Instruments Tray with Lid
 HM-82-4524 100x150x25mm
 HM-82-4525 150x200x40mm
 HM-82-4526 200x250x45mm
 HM-82-4527 250x300x50mm
 HM-82-4528 300x350x50mm
 HM-82-4529 150x300x50mm
 HM-82-4530 200x300x50mm
 HM-82-4531 230x150x50mm



Burr Tray
 HM-82-4532
 190x100x20mm



Cathetes Tray with Lid
 HM-82-4533 300x80x40mm
 HM-82-4534 350x90x45mm
 HM-82-4535 400x100x50mm



Scaler Tray with cover
 HM-82-4536
 200x100x16mm





**Instruments Box
with Hooks**

- HM-82-4537 170x70x30mm
- HM-82-4538 180x80x40mm
- HM-82-4539 200x100x40mm
- HM-82-4540 230x120x50mm
- HM-82-4541 250x125x50mm
- HM-82-4542 300x150x50mm
- HM-82-4543 350x170x50mm
- HM-82-4544 400x200x90mm
- HM-82-4545 500x200x120mm



Instruments Box

- HM-82-4546 170x70x30mm
- HM-82-4547 180x80x40mm
- HM-82-4548 200x100x40mm
- HM-82-4549 230x120x50mm
- HM-82-4550 250x125x50mm
- HM-82-4551 300x150x50mm
- HM-82-4552 350x170x50mm
- HM-82-4553 400x200x90mm
- HM-82-4554 500x200x120mm



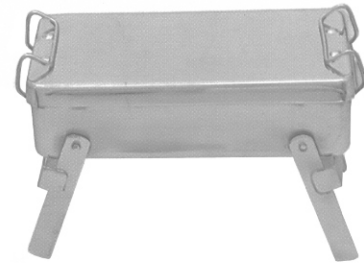
**Instruments Box
Perforated**

- HM-82-4555 200x100x40mm
- HM-82-4556 250x150x40mm
- HM-82-4557 300x150x40mm



Electric Sterilizer

- HM-82-4558 200x100x120mm
- HM-82-4559 250x120x140mm
- HM-82-4560 300x150x150mm
- HM-82-4561 350x170x170mm
- HM-82-4562 400x200x180mm
- HM-82-4563 450x230x190mm



Non Electric Sterilizer

- HM-82-4564 200x100x65mm
- HM-82-4565 250x125x65mm
- HM-82-4566 300x150x100mm
- HM-82-4567 350x170x65mm
- HM-82-4568 400x200x100mm



Electric Sterilizer
HM-82-4569
280x125x65mm

- HM-82-4570 125x80mm
- HM-82-4571 125x120mm
- HM-82-4572 150x100mm
- HM-82-4573 150x150mm
- HM-82-4574 180x180mm
- HM-82-4575 190x140mm
- HM-82-4576 190x190mm
- HM-82-4577 200x200mm
- HM-82-4578 240x120mm
- HM-82-4579 240x240mm
- HM-82-4580 290x140mm
- HM-82-4581 290x240mm
- HM-82-4582 290x290mm
- HM-82-4583 340x160mm
- HM-82-4584 340x340mm
- HM-82-4585 390x150mm
- HM-82-4586 390x200mm
- HM-82-4587 390x290mm



Sterilizer Drum



MOMAD DENTAL SUPPLIES

Hussaini Road, Muzaffarpur,
Sialkot-51310 Pakistan

Tel / Whats App: 0092 320 2952030

Email: info@momadental.com
momaddentalsupplies@gmail.com

Web: <https://momaddental.com>